

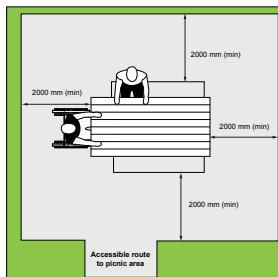

Accessibility Design Standards



[Page intentionally left blank for printing purposes.]



Accessibility Design Standards

Second Edition, November 2015

W.R. Newell, P. Eng.
General Manager, Infrastructure Services Department

City of Ottawa
Infrastructure Services Department
Business and Technical Services Branch
100 Constellation Drive, 6th Floor East
Ottawa, Ontario K2G 6J8
Email: standardssection@ottawa.ca

The City of Ottawa would like to acknowledge and thank the City of Markham for permitting this adaptation of their Accessibility Design Guidelines (June 2011).

Revision History

First Edition	November 2012	First release of compiled Accessibility Standards
Second Edition	November 2015	Updates to harmonize with AODA's Design of Public Spaces Standards and OBC Amendments, new sections, etc.

Table of Contents

1.0 Introduction

1.1	Regulatory Framework.....	6
1.2	Standard Organization.....	14

2.0 Common Elements (Exterior and Interior)

2.1	Ground and Floor Surfaces	19
2.2	Ramps.....	23
2.3	Stairs.....	29
2.4	Guards and Handrails	33
2.5	Overhanging and Protruding Objects.....	35
2.6	Rest Areas	38
2.7	Tactile Walking Surface Indicators	40
2.8	Drinking Fountains	42
2.9	Public Telephones	45
2.10	Seating, Tables and Work Surfaces	49
2.11	Accessibility During Construction	52

3.0 Exterior Elements

3.1	Parking.....	61
3.2	Passenger Loading Zones.....	66
3.3	Exterior Paths of Travel	69
3.4	Curb Ramps and Depressed Curbs	74
3.5	Accessible Pedestrian Signals	79

4.0 Interior Environments

4.1	Entrances	83
4.2	Doors and Doorways	85
4.3	Interior Accessible Routes	96
4.4	Elevating Devices	100
4.5	Washrooms.....	103
4.6	Showers	118

5.0 Systems, Controls and Communications

5.1	Controls and Operating Mechanisms.....	125
5.2	Assistive Listening Systems.....	128
5.3	Public Address Systems	130
5.4	Acoustics.....	132
5.5	Security Systems	134
5.6	Fire and Life Safety Systems	136
5.7	Lighting	140
5.8	Signage and Wayfinding	143
5.9	Windows.....	149

6.0 Special Facilities and Spaces

6.1	Assembly Areas.....	153
6.2	Meeting and Multi-Purpose Rooms	157
6.3	Cultural and Art Facilities	159
6.4	Cafeteria and Dining Facilities	161
6.5	Kitchens and Kitchenettes	164
6.6	Libraries	172
6.7	Recreational and Community Facilities.....	176
6.8	Change Rooms	180
6.9	Balconies and Terraces	184
6.10	Service Counters	186
6.11	Waiting and Queuing Areas.....	189
6.12	Elevated Platforms or Stages	192
6.13	Visitability - Housing	194
6.14	Outdoor Public-Use Eating Areas.....	197
6.15	Recreational Trails, Beach Access Routes and Boardwalks	199
6.16	Recreational Trail Design Checklist	206
6.17	Inclusive Play Spaces	209
6.18	Inclusive Play Space Design Guide	215
6.19	Inclusive Play Space Checklist.....	219
6.20	Public Transit	221
6.21	Office Environments (Reserved)	227

7.0 Appendices

7.1	Glossary	231
7.2	List of Figures	236
7.3	List of Tables	240
7.4	Exterior Maintenance Checklist	241
7.5	Interior Maintenance Checklist.....	243
7.6	Feedback Form.....	246
7.7	Tactile Signage Standard Pictograms.....	248

[Page intentionally left blank for printing purposes.]

Introduction

1.0

Table of Contents

Mandate	3
1.1 Regulatory Framework	6
1.1.1 The Ontarians with Disabilities Act, 2001	6
1.1.2 The Accessibility for Ontarians with Disabilities Act (AODA, 2005)	7
1.1.3 AODA Accessibility Standards	8
1.1.4 The Ontario Human Rights Code (OHRC).....	8
1.1.5 The Ontario Building Code (OBC, 2012)	9
1.1.6 Canadian Standards Association “Accessible Design for the Built Environment” (CSA B651-12)	10
1.1.7 The Ontario Planning Act.....	10
1.1.8 Scope and Application	11
1.1.9 Existing Barriers and Conditions	12
1.1.10 Implementation Alternatives.....	12
1.1.11 Exceptions.....	13
1.1.12 Other References.....	13
1.2 Standard Organization	14
1.2.1 Tables, Figures and Graphics	14
1.2.2 Dimensions	14
1.2.3 Definitions	14
1.2.4 Special Note - “High Tonal Contrast”	15
1.2.5 Feedback Form	15

[Page intentionally left blank for printing purposes.]



Introduction

1.0

Mandate

The City of Ottawa intends to be a leader in developing accessible environments for all, embracing the principles of “universal design”, defined as the:

“design of products and environments to be usable by all people, to the greatest extent possible, without the need for adaptation or specialized design.”

Source: North Carolina State University, Center for Universal Design, 1997

The City of Ottawa Accessibility Design Standards (ADS) were developed with recognition of the following:

- **Diversity:** Encourages the inclusion and integration of diverse communities, appreciating differences, while promoting a common goal to make Ottawa a more accessible place to live, work and play for everyone;
- **Barrier Removal:** Preventing and removing obstructions that create exclusion;
- **Provincial Directions:** Accessibility standards in the areas of customer service, information and communication, employment, transportation and the built environment, developed under the Accessibility for Ontarians with Disabilities Act (AODA) initiative; and
- **Changing Demographics:** People with varying types of disabilities comprise a significant proportion of the population. The proportion of seniors within the Canadian population is also increasing rapidly and for some seniors, acquiring a disability may also increase with age. Currently, people with disabilities represent one in seven Ontarians. Due primarily to aging, one in every five Ontarians is expected to have a disability within 20 years.

With accessibility requirements and related best practices continually evolving, particularly in light of recent changes to

Provincial legislation, the development and update of the City of Ottawa’s Accessibility Design Standards (ADS) will be an ongoing process. These standards are a “living document”, evolving over time to meet best practices, and future changes that may be related to the OBC, CSA and AODA updates.

During the planning, design and construction of accessible spaces and buildings, a range of opportunities exist to optimize independent access for persons with disabilities but also to improve accessibility for all users. **The purpose of the City’s Accessibility Design Standards is to provide practical examples of solutions that optimize accessibility for new construction or for the redevelopment of existing spaces and facilities owned, leased or operated by the City of Ottawa.**

Finally, the City is committed to identifying, removing and preventing barriers, but also intends to demonstrate leadership in an effort to encourage the private sector to follow the City’s designs related to both existing and new facilities.

Understanding Disability

Using a Cross-Disability Perspective

Knowledge of the basic characteristics of different disabilities and the resulting barriers is critical towards understanding individual needs and how to address them when designing the built environment. Common “types” of disabilities are identified within these Standards to assist with understanding how users with disabilities interact with elements of the built environment. A list of key “types” of disabilities include but are not limited to:

- **Auditory Disabilities**
- **Intellectual Disabilities**
- **Physical Disabilities**
- **Developmental Disabilities**
- **Visual Disabilities**
- **Learning Disabilities**
- **Mental Health Disabilities**

Best Practice

Consideration of “Universal Abilities”

The intent is to recognize and understand that everyone will experience variations in abilities throughout their lifespan, or ‘universal’ abilities.

This approach considers no distinction between people with or without disabilities, focusing on identifying what is usable and safe for everyone in the community. The focus is also on extending the ideals of accessible design to routinely under-served populations, like people of short stature, seniors, pregnant women, parents with children in strollers, people who speak different languages and others.

Principles of Universal Design

- 1** ----- **Equitable Use** ----- The design is useful and marketable to people with diverse abilities.
- 2** ----- **Flexibility in Use** ----- The design accommodates a wide range of individual preferences and abilities.
- 3** ----- **Simple and Intuitive** ----- Use of the design is easy to understand, regardless of the user's experience, knowledge, language skills or current concentration level.
- 4** ----- **Perceptible Information** ----- The design communicates necessary information effectively to the user, regardless of ambient conditions or the user's sensory ability.
- 5** ----- **Tolerance for Error** ----- The design minimizes hazards and the adverse consequences of accidental or unintended actions.
- 6** ----- **Low Physical Effort** ----- The design can be used efficiently and comfortably and with a minimum of fatigue.
- 7** ----- **Size and Space for Approach and Use** ----- Appropriate size and space is provided for approach, reach, manipulation and use regardless of user's body size, posture or mobility.

Source: North Carolina State University, Centre for Universal Design, 1997.

Reference

For more information on Ottawa's Accessibility Advisory Committee, refer to: www.ottawa.ca/en/city-hall/your-city-government/advisory-committees/accessibility

1.1 Regulatory Framework

The development of these Standards is driven by the regulatory environment and important Provincial accessibility legislation and related requirements, which also supports the City's position and initiative to be proactive and a leader in developing inclusive communities.

While the City of Ottawa Accessibility Design Standards (ADS) have been developed to assist with compliance with relevant legislation and related requirements, users are cautioned that the ADS by no means attempts to duplicate all the details of those references. Users must be familiar with the relevant legislation that affects a particular project or situation to ensure compliance.

The regulatory framework from which the ADS draws is summarized as follows:

1.1.1 The Ontarians with Disabilities Act, 2001

In December 2001, the Government of Ontario passed the *Ontarians with Disabilities Act, 2001* (ODA) to improve opportunities for people with disabilities. Under the ODA, municipalities, regardless of size, must prepare annual accessibility plans and make them available to the public. Municipalities must also include people with disabilities in the planning process, either as members of formal accessibility committees that are required to be established under the Act, or as participants in the consulting process. Municipal Accessible Advisory Committees (AAC's) must be established by municipalities with populations over 10,000. Under the ODA, accessibility plans are required to review and report on barriers that are identified within a municipality's buildings, facilities, programs, practices, services, by-laws and policies. Accessibility plans must also report on the steps that the municipality has taken to identify, remove and prevent barriers for people with disabilities.

In summary, municipal accessibility plans are required to include the following:

- Measures taken to identify, remove and prevent barriers to persons with disabilities;
- Measures in place to ensure that proposals for by-laws, policies, programs, practices and services are formally evaluated to determine their effect on accessibility for persons with disabilities;
- A list of the by-laws, policies, programs, practices and services that will be reviewed in the year the plan is implemented in order to identify barriers to persons with disabilities;
- The steps and initiatives to take place annually that will identify, remove and prevent barriers to persons with disabilities;
- How the accessibility plan and related information is made available to the public; and

- The steps to consider accessibility in planning processes as well as when procuring goods and services from companies, granting business licences and approving plans for subdivisions.

Overall, the ODA does not expect municipalities to remove every existing barrier immediately, allowing for the removal of barriers to accessibility over time. The ODA provides municipalities with flexibility to identify their own priorities and to decide on what level of detail they will include in their annual accessibility plans. This is based on the recognition and assumption that accessibility plans must be developed on sound planning principles, with issues addressed according to priorities and needs identified during the public consultation process.

1.1.2 The Accessibility for Ontarians with Disabilities Act (AODA, 2005)

The Accessibility for Ontarians with Disabilities Act, 2005 (AODA) came into effect on June 13, 2005. Although the AODA is now law, the planning requirements of the ODA still remain in force. Section 29 of the AODA continues the AAC's role to review site plans under the *Planning Act*, and to advise municipal council on issues related to the accessibility of the built environment, including municipal sites and facilities.

Additionally, the AODA requires accessibility standards to be established by the Province. In summary, the purpose of the AODA is to:

- Develop, implement and enforce accessibility standards in order to achieve accessibility for Ontarians with disabilities with respect to goods, services, kiosks, facilities, accommodation, employment, buildings, structures and premises by January 1, 2025.
- Provide for the involvement of persons with disabilities, the Government of Ontario and representatives of industries and of various sectors of the economy in the development of accessibility standards.

The Province of Ontario established “Standards Development Committees” (SDC's) in the areas of customer service, transportation, information and communications, the built environment and employment.

These provincial accessibility standards set out the measures, policies, practices and other steps needed to improve and prevent barriers for people with disabilities. The standards apply to both the public and private sector. Currently there are two regulations in place in Ontario: the Accessibility Standards for Customer Service Regulation and the Integrated Accessibility Standards Regulation.

Reference

For more information about the *Ontarians with Disabilities Act, 2001* and “Complementary Amendments” to other provincial legislation made by the ODA, visit: www.mah.gov.on.ca

Note

For more information on provincial legislation visit the Ministry of Economic Development, Employment & Infrastructure at: www.mcscs.gov.on.ca/en/mcscs/programs/accessibility/

1.1.3 AODA Accessibility Standards

Accessibility standards have been developed as part of the AODA standards development process, including:

- **Customer Service:** States what businesses and other organizations in Ontario must do to make the provision of their goods and services more accessible to people with disabilities. For municipalities, it requires an accessible customer service policy, practices and procedures, along with employee training. Status: Approved as “Accessibility Standards for Customer Service”, Ontario Regulation 429 / 07.
- The ***Integrated Accessibility Standards Regulation (IASR)***, Ontario Regulation 191/11, includes general requirements as well as sections on **Information and Communication, Employment, Transportation and the Design of Public Spaces**. The Ottawa Accessibility Design Standards have been prepared in response to the IASR general requirement on procurement which states that designated public sector organizations shall incorporate accessibility design criteria and features when procuring or acquiring goods, services, or facilities, except where it is not practicable to do so.
 - » **General Requirements:** Regulatory requirements that apply across all standards of the IASR.
 - » **Information and Communications:** Identifies how organizations are required to create, provide and receive accessible public information and communications in various formats such as online, print, verbal and digital.
 - » **Employment:** Requires employers to provide for accessibility across all stages of the employment life cycle.
 - » **Transportation:** Requirements to make services and vehicles accessible to people with disabilities.
 - » **Design of Public Spaces:** Addresses exterior areas of the built environment, such as outdoor paths of travel, recreational trails, playgrounds, accessible on and off-street parking and service-related elements.

1.1.4 The Ontario Human Rights Code (OHRC)

The Ontario Human Rights Code (‘the Code’) protects all Ontario residents from discrimination and harassment in specific areas including services, housing, contracts and employment. Under the Code, every person has a right to equal treatment with respect to services, goods and facilities, without discrimination because of disability, race, ancestry, place of origin, colour, ethnic origin, citizenship, creed, sex, sexual orientation, age, marital status, same-sex partnership status, and family status. Further, the Code recognizes that people with disabilities have the right to be able to access services, jobs and housing, with the right to assume the same responsibilities and duties as everyone else.

Employers, landlords, service providers and others have a duty to consider the needs of people with disabilities. This can include ways to apply the principles of inclusive or universal design for the construction or renovation of buildings and facilities, as well as their application to related processes, programs and services. If systems, facilities or other elements of the built environment or people's attitudes create discriminatory barriers, then they must be removed or changed. Where it is impossible to remove these barriers without undue hardship, then accommodations must be made so that people with disabilities can participate fully.

In summary, there are two important concepts related to the Ontario Human Rights Code that are critical to recognize as the City's Accessibility Design Standards are implemented:

1. The Ontario Human Rights Code has primacy over all other provincial legislation including the Ontario Building Code, the *Ontarians with Disabilities Act, 2001* and the *Accessibility for Ontarians with Disabilities Act, 2005*; and
2. Its intent is to remedy the situation for the person and to prevent further barriers.

1.1.5 The Ontario Building Code (OBC, 2012)

Accessibility amendments to Ontario's Building Code came into force on January 1, 2015.

The accessibility requirements, or "barrier-free design" requirements as they are referred to in the OBC (Section 3.8), are generally recognized as representing a minimum standard for accessibility.

The requirements of the OBC specifically related to accessibility can be summarized as follows:

- Applies to most new construction and extensive renovation; and
- Amended requirements cover a range of areas, such as parking, entrances, elevators, washrooms, barrier-free access, ramps, stairs, signs and exits.

Most importantly, compliance with the OBC does not constitute compliance with the Ontario Human Rights Code. This is a key reason why additional accessibility design standards for the built environment are required to address the needs of users with varying disabilities.

Best Practice

The Provincial Policy Statement (PPS, 2005) identifies the importance of improving accessibility for persons with disabilities and seniors. Additionally, the site plan control process is an early opportunity for City staff to address the accessibility of the built environment through its review of development proposals.

1.1.6 Canadian Standards Association “Accessible Design for the Built Environment” (CSA B651-12)

Currently the Canadian Standards Association’s “Accessible Design for the Built Environment” (CSA B651-12) is recognized as a voluntary national built environment standard for Canada. The CSA requirements were updated in 2012 and it is considered more comprehensive than the OBC. However, the CSA also has limitations; for example, the CSA contains very little with respect to signage and wayfinding accessibility requirements, or fire and life safety issues.

Overall, the City of Ottawa Accessibility Design Standards go above and beyond the minimum requirements of the OBC and the CSA B651-12, representing a “best practice” approach to providing accessible design. The OBC will be followed as required by law, however, there is no reason that the City’s enhanced design standards for accessibility cannot be implemented where the intent and formal requirements of the OBC is also achieved.

1.1.7 The Ontario Planning Act

Overall, the *Planning Act* provides the legislative framework for land use planning in Ontario. It is the basis for the provincial interests relative to municipal land use planning, local planning administration, the preparation of planning policies, development control, land division and the public’s right to participate in the planning process. Following the passing of the ODA, the Province amended the *Planning Act* in several sections, summarized as follows:

1.1.7.1 Section 2: Provincial Interest

Section 2 of the *Planning Act* requires planning authorities, in carrying out their responsibilities under the Act, to have regard to accessibility for persons with disabilities for all facilities, services and matters to which the Act applies. Therefore, those who have the responsibility for making planning decisions in the municipality and the province shall consider the level of accessibility for people with disabilities to all facilities and services that are guided by the Act.

1.1.7.2 Section 41: Reviewing Site Plans

The *Planning Act* makes provisions for accessibility for persons with disabilities as part of the site plan process. Site plan control helps facilitate universal accessibility to buildings and the spaces surrounding the buildings on a development site. Through this process, municipalities can review a developer’s plans and drawings, and require the provision of facilities for accessibility to a development proposal. Section 12(5) of the ODA also specifies that if a municipality has an AAC, it may request to review site plans and drawings described in Section 41 of the *Planning Act* (site plan control) that are submitted to support planning applications. Section 12(6) of the Act identifies that municipal councils must supply such drawings to an AAC in a timely manner.

1.1.7.3 Section 51: Reviewing Plans of Subdivision

Under the *Planning Act*, when considering a draft plan of subdivision, planning approval authorities are to have regard to accessibility for persons with disabilities. Further, section 51 now allows approval authorities to require land dedication for pedestrian and bicycle pathways, and public transit ways in new subdivision proposals.

1.1.7.4 Section 53: Reviewing Applications to Sever Land (Consents)

When reviewing consent applications, municipalities need to have regard to accessibility for persons with disabilities. This is similar to the provision regarding the review of plans of subdivision.

[Source: Adapted From “The Planning Act and Accessibility”. Ontario Ministry of Municipal Affairs and Housing]

1.1.8 Scope and Application

The accessible design criteria provided in these Standards aims to make all City-owned or leased spaces, buildings, infrastructure and elements accessible to Ottawa residents, employees and visitors, as part of any new construction or redevelopment activities. The intent is for the City to clearly identify the accessibility criteria and features included in the procurement of its facilities and to demonstrate proactive steps towards making all facilities and sites accessible. The City of Ottawa recognizes that addressing accessibility issues as early as possible in the planning and design phases of new construction and redevelopment projects is the most practical and cost effective way to ensure accessible and inclusive environments.

These accessibility design Standards are:

- **Mandatory for all new construction and redevelopment of existing spaces and facilities, owned, leased or operated by the City of Ottawa;**
- **Intended to be applied to the greatest extent possible for retrofit, alterations or additions to existing spaces and facilities owned, leased or operated by the City of Ottawa;**
- **Encouraged to be implemented by other sectors and organizations within Ottawa; and,**
- **Recognized as addressing the needs of diverse users, with or without disabilities, to ensure inclusive environments for all.**

These accessibility design Standards are not applicable to the following spaces and areas:

- equipment service rooms or spaces;
- elevator machine rooms;
- janitor rooms;
- crawl spaces; and
- other similar areas identified in the Ontario Building Code.

Although the design criteria contained in these Standards may differ from the requirements of the AODA, Ontario Building Code and the Canadian Standards Association's "Accessible Design for the Built Environment (CSA B651-12), the intent is that AODA, OBC and CSA requirements are used as the baseline and minimum requirements that are to be applied. The Accessibility Design Standards reflect an optimum level of accessibility for the design of the built environment, as the Standards are intended to meet or go beyond the requirements of the AODA, OBC and CSA.

By making these accessibility design Standards applicable to all planning, design, construction and development activities, Ottawa will demonstrate its commitment to proactive measures to eliminate and prevent barriers faced by persons with disabilities and older adults.

1.1.9 Existing Barriers and Conditions

Barrier removal for existing City spaces, infrastructure, facilities and elements is conducted annually through a list of priorities established in the City's Accessibility Plan. **The City intends to implement these accessibility standards to the greatest extent possible, for all renovations and alterations to facilities, sites and elements of the built environment.**

1.1.10 Implementation Alternatives

Consistent with the policies of national and international accessibility standards, the information within these Standards is not intended to prevent the use of other designs, products or technologies as alternatives to those identified. This assumes that the implementation of these alternatives will result in an equivalent or an increased level of accessibility, meeting the principles of universal accessibility.

Implementation alternatives will be evaluated on a project-by-project basis by City staff, in collaboration and consultation with all relevant stakeholders, including the Ottawa Accessibility Advisory Committee, as required.

It is the intent of the City to review these Standards annually to ensure the highest level of accessibility is achieved and to ensure the Standards reflect any future changes to the legislation.

1.1.11 Exceptions

When exceptions to the Accessibility Design Standards are approved by the appropriate City of Ottawa authority, those exceptions must be thoroughly documented and provided in writing to both the City of Ottawa Department, which is overseeing the work as well as the City of Ottawa Accessibility Office (accessibilityoffice@ottawa.ca).

Financial constraints are not typically regarded as an acceptable rationale for an exception to be approved.

There are some exceptions allowed by the IASR which are specifically related to heritage, historic, or environmental effects. The IASR also notes exceptions where it is not practicable to comply with those requirements because existing physical or site constraints prohibit modification or addition of elements, spaces or features - examples are noted with the individual subsections of the IASR.

1.1.12 Other References

Several other key references were consulted in the creation and revision of these Accessibility Design Standards, including:

- Canadian National Institute for the Blind (CNIB). (2009). ***Clearing Our Path - Universal design recommendations for people with vision loss.***
- Global Alliance on Accessible Technologies and Environments (GAATES). (2014). ***Illustrated Technical Guide to the Accessibility Standard for the Design of Public Spaces.***
- Parks and Recreation Ontario. (2014). ***Pathways to Recreation: Learning about Ontario's Accessibility Standard for the Design of Public Spaces - Guidebook.***
- AccessON. (April 2014). ***A Guide to the Integrated Accessibility Standards Regulation.***
- International Organization for Standardization (ISO). (2011). ***ISO 21542:2011 Accessibility and Usability of the Built Environment.***

1.2 Standard Organization

These Standards were organized to provide accessibility criteria in the following sections, in order to group and identify issues that are related. These sections are identified and colour-coded as follows:

1.0 Introduction	2.0 Common Elements: Exterior and Interior	3.0 Exterior Environments
4.0 Interior Environments	5.0 Systems, Controls and Communications	6.0 Special Facilities and Spaces
7.0 Appendices		

These Sections are further divided into additional subsections that refer to specific site or facility elements. At the start of each of section, the “Application” of the Standards is identified to assist with implementation and how each section relates or applies to the built environment, element or feature.

1.2.1 Tables, Figures and Graphics

Throughout these Standards, several tables, figures and graphics are provided to assist the user with understanding the application of the accessibility criteria and design issues under consideration.

1.2.2 Dimensions

The dimensions for specific accessibility criteria are stated in millimeters (mm) or metres (m) throughout this document, under the metric system of units, rounded up to the nearest multiple of five. Dimensions that are not marked as “maximum” or “minimum” are absolute, unless otherwise indicated. All dimensions for construction purposes are subject to conventional industry tolerances.

1.2.3 Definitions

Throughout this document, terminology may be used that may not be familiar or understood. Definitions for key words are provided in Section 7.1 “Glossary”.

1.2.4 Special Note - “High Tonal Contrast”

Users of these Standards will note the consistent use of the term “high tonal contrast”. Tonal contrast refers to the difference in colour and brightness between one surface or element and its adjacent surface. Effective tonal contrast can be used to locate a particular feature, for example using a different colour and / or brightness for a handrail compared to the surface around the handrail.

In order to provide an effective differentiation between accessibility features and their surrounding surfaces, these Standards call for the use of “high tonal contrast” as opposed to simply “tonal contrast” for many elements. “High” refers to the requirement to provide a very different colour and / or brightness level. For example, high tonal contrast can be achieved using dark brown / white or dark blue / white, compared to poor tonal contrast of yellow / grey or light blue / white.

More guidance on tonal contrast, and the best practice of providing a colour and brightness contrast of 70% or more can be found in:

- Canadian National Institute for the Blind (CNIB). (2009). ***Clearing Our Path - Universal design recommendations for people with vision loss.***
- Global Alliance on Accessible Technologies and Environments (GAATES). (2014). ***Illustrated Technical Guide to the Accessibility Standard for the Design of Public Spaces.***

1.2.5 Feedback Form

The City of Ottawa recognizes that accessibility best practices continue to evolve and change over time, with the expectation that these Standards are recognized as a “living document” and will be updated on a regular basis. A feedback form is provided in Section 7.6, for any recommendations on how to improve this document or to provide new information.

[Page intentionally left blank for printing purposes.]

Common Elements: Exterior and Interior

2.0

Table of Contents

2.1	Ground and Floor Surfaces	19
2.2	Ramps	23
2.3	Stairs	29
2.4	Guards and Handrails	33
2.5	Overhanging and Protruding Objects	35
2.6	Rest Areas	38
2.7	Tactile Walking Surface Indicators	40
2.8	Drinking Fountains	42
2.9	Public Telephones	45
2.10	Seating, Tables and Work Surfaces	49
2.11	Accessibility During Construction	52

[Page intentionally left blank for printing purposes.]



2.1

Application

This section applies to ground and floor surfaces throughout interior and exterior environments. The type of materials and finishes used for ground and floor surfaces are essential in determining accessibility.

Reference

- Sec. 3.3 Exterior Paths of Travel
- Sec. 4.3 Interior Accessible Routes
- Sec. 5.4 Acoustics
- Sec. 5.7 Lighting

Note

Irregular surfaces, such as cobblestones or pea-gravel finished concrete are difficult for both walking and pushing a wheeled mobility device.

The use of pavers along accessible routes should be carefully considered since they may heave or settle due to weather conditions and can become potential tripping hazards.

When using pavers, provide controls to prevent any potential heaving due to frost and minimize the number of joints.

Pavers may be used as accent banding to delineate the accessible route.

Uneven surfaces can create unpleasant and damaging vibration for wheeled mobility aids users.

Sand and gravel surfaces are extremely difficult surfaces for users of mobility aids to maneuver.

Note

A firm surface does not change under vertical force / pressure.

A stable surface does not change or erode under angular forces.

Hard floor surfaces, such as marble or terrazzo may amplify footsteps and add another level of noise for persons who are Deaf, deafened or hard of hearing.

2.1.1 Surfaces

Ensure all ground and floor surfaces in interior and exterior environments:

- a. are firm, stable and slip-resistant;
- b. have a matte finish to minimize glare;
- c. are well-drained;
- d. have joints between surfaces no wider than 6 mm (preferred) or 10 mm (maximum) (**Figure 1**); and
- e. where ground and floor surfaces have a change in level:
 - i. no bevel is required (e.g., vertical change permitted), where the change in level is less than 6 mm;
 - ii. provide a beveled slope of 1:2 (maximum - the ratio rise to run), where the change in level is between 6 and 13 mm;
 - iii. provide a slope, ramp or curb ramp, where the change in level is greater than 13 mm; and
 - iv. for exterior ground surfaces, refer to Section 3.3 Exterior Paths of Travel for additional details.

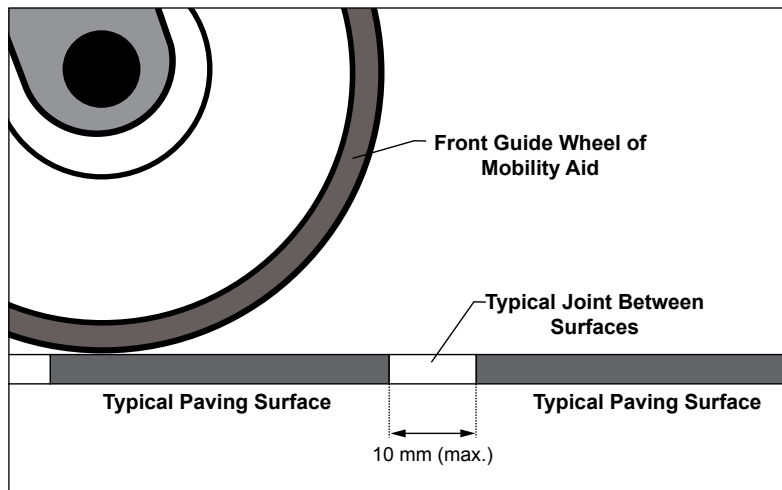

Figure 1: Joints Between Surfaces - Section View



Ensure a smooth transition is provided between sidewalk segments.

2.1.2 Carpets

Where carpeting is used:

- a. ensure it is securely fastened;
- b. ensure combined carpet and pad height does not exceed 13 mm;
- c. ensure any cushion, under padding or backing is firm to reduce rolling resistance for wheeled mobility aids; and
- d. ensure it is a low level loop or level cut / uncut pile.

Note

Disruptive, confusing and heavily patterned ground or floor surface designs can be misinterpreted as level changes by people with vision loss and are not accessible.

2.1.3 Floor Mats

Where floor mats are used:

- a. ensure they are securely fixed or placed in a depression that is level with surrounding floor area;
- b. ensure maximum mat height of 13 mm with beveled edges; and
- c. provide high tonal contrast between floor mats and surrounding surfaces.

Note

Tonal contrasted floor mats can provide textural and visual cues for people with vision loss. They can be used to indicate doorways or circulation intersection.



Example of a recessed floor mat system which is preferred.

Best Practice

Avoid the use of any grate, opening or cover along accessible routes, especially high traffic areas, in order to prevent any potential tripping hazards.

Note

Openings larger than 13 mm may potentially catch wheels of mobility aids, canes or crutches.

2.1.4 Gratings and Covers

Openings can include sewer catch basin covers or drainage grates, utility covers and tree grates. Where there are any openings along the path of travel, or where gratings or other covers are required in both interior and exterior environments:

- ensure openings do not allow passage of an object that has a diameter greater than 13 mm (**Figure 2a & b**); and
- ensure that elongated openings are oriented perpendicular to the pedestrian path of travel.

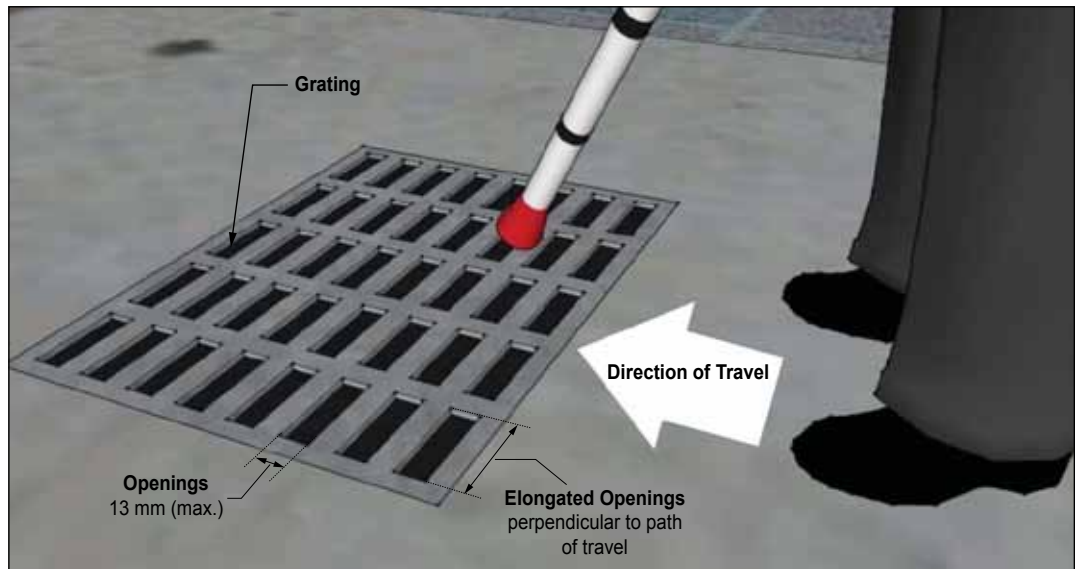

Figure 2a: Grating Opening

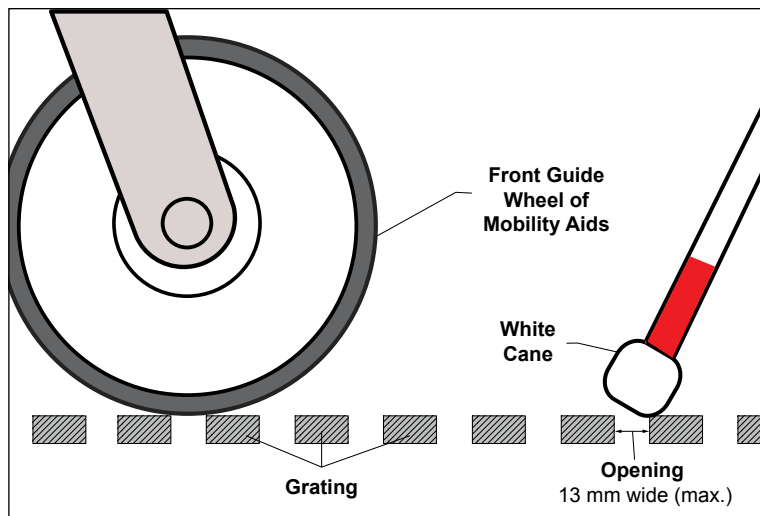

Figure 2b: Gratings - Section View



2.2

Application

This section applies to ramps provided as part of an accessible route within exterior or interior environments.

Additionally, refer to Ontario Building Code (OBC) and Integrated Accessibility Standards Regulation (IASR) for requirements for ramps.

Reference

- Sec. 2.1 Ground and Floor Surfaces
- Sec. 2.4 Guards and Handrails
- Sec. 2.7 Tactile Walking Surface Indicators
- Sec. 5.7 Lighting

Note

It is preferred to avoid providing ramps in new construction where alternate universal design solutions are possible.

Best Practice

Where ramps are specifically designed for use by persons with vision loss, a ramp surface of up to 1500 mm wide is preferred, in order to allow space for a companion or guide dog.

2.2.1 Design Features

- a. provide a clear width of 1100 mm (minimum);
- b. ensure individual ramp sections are no longer than 9000 mm (**Figure 3**);
- c. provide landings:
 - i. at top and bottom of ramp;
 - ii. where there is any directional change; and
 - iii. between each ramp section where overall length of ramp exceeds 9000 mm (**Figure 5**);
- d. provide lighting in accordance with Section 5.7 Lighting requirements, as applicable;
- e. provide handrails on both sides of the ramp (**Figure 8**); and
- f. provide a wall or guard on both sides of the ramp (**Figure 9**).

2.2.1.1 Running Slope

- a. ensure maximum gradient of 1:15 (6.67%) (**Figure 3**).

2.2.1.2 Cross-Slope

- a. ensure maximum gradient of 1:50 (2%).

2.2.1.3 Edge Protection

Provide edge protection along ramps and landings:

- a. with a curb at least 75 mm high (minimum) high, where no solid enclosure or solid guard is provided (**Figure 4a**); and
- b. with railings or other barriers that extend to within 50 mm of the finished ramp surface (**Figure 4b & 4c**).

2.2.1.4 Colour Contrasting Strip

- a. provide a colour contrasted and slip-resistant strip at the beginning and end of ramp, and where landings meet a slope change (**Figure 3**); and
- b. ensure strips are 50 ± 10 mm wide, extending along the width of the ramp.

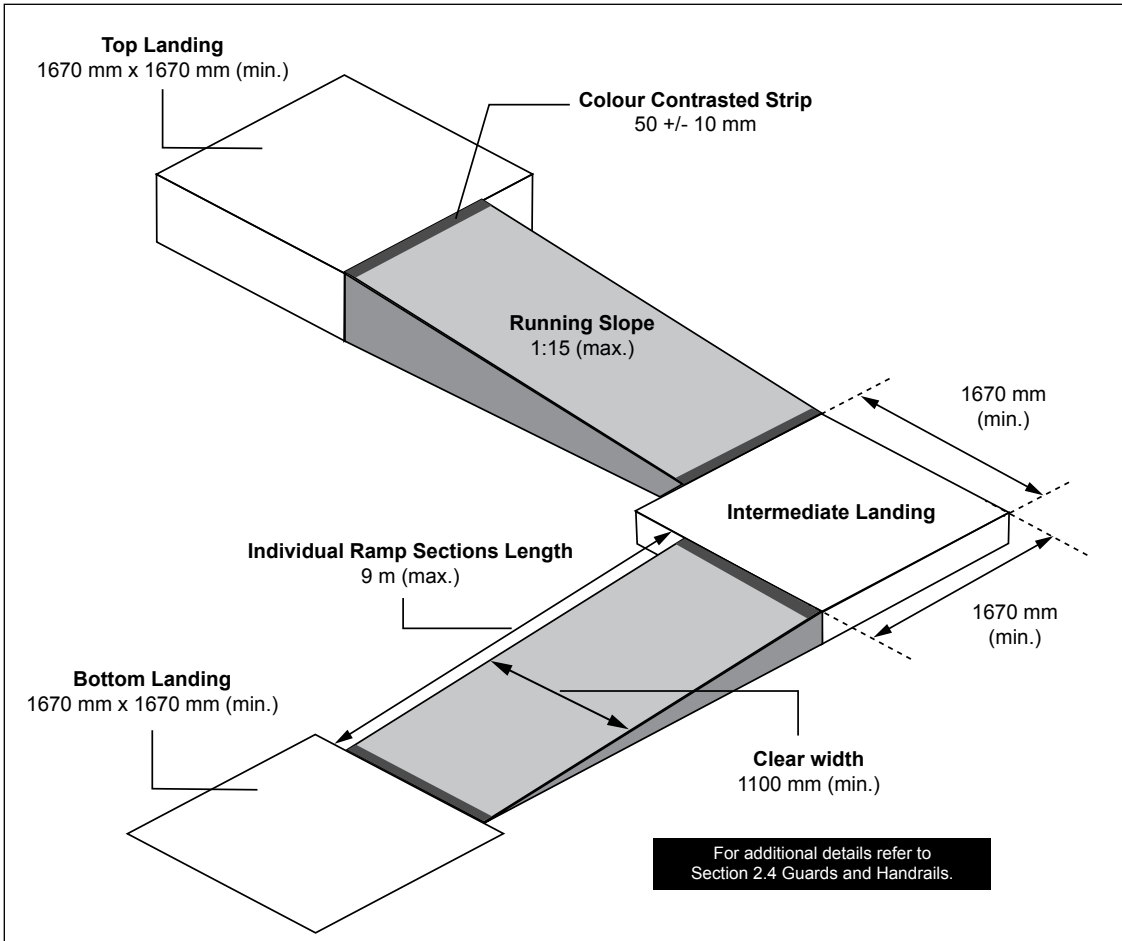

Figure 3: Ramp Design Features

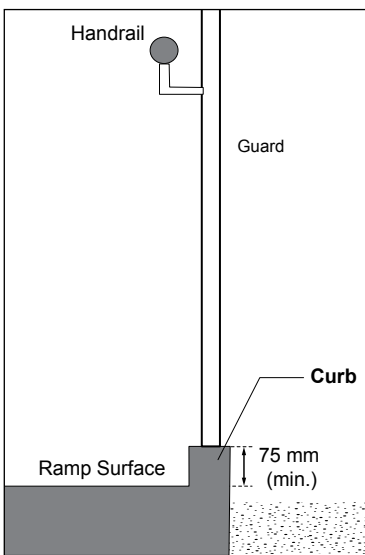

Figure 4a: Curb Protection - Cross Section

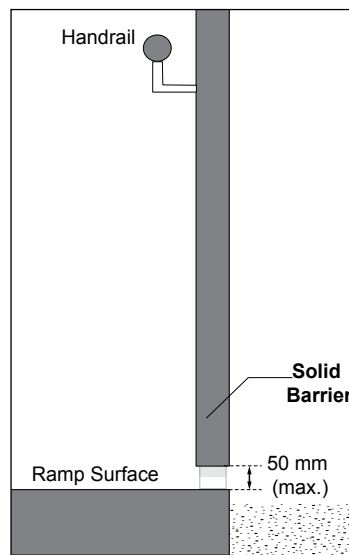

Figure 4b: Solid Barrier Protection - Cross Section

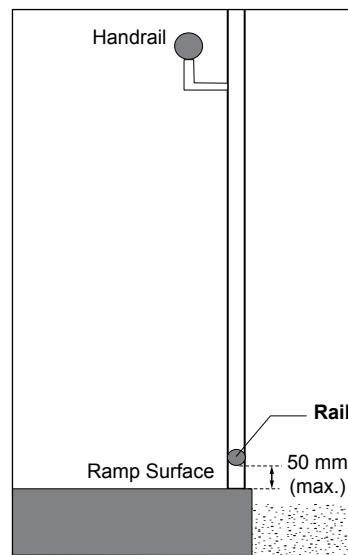

Figure 4c: Rail Protection - Cross Section

Best Practice

Exterior ramp and landing surfaces should be heated to prevent snow and ice accumulation during winter conditions.

Where space is available, a landing dimension of 2250 mm by 2250 mm or 3150 mm by 3150 mm is preferred in order to accommodate powered wheelchairs and large scooters, respectively.

2.2.2 Landings

- ensure landings are level and have a cross slope that is not steeper than 1:50 (2%);
- provide clear space of 1670 mm by 1670 mm (minimum) at top and bottom landings and where there is an abrupt change in direction (**Figure 3**);
- provide clear space of 1670 mm (minimum) long and at least the same width as the ramp for an in-line landing;
- where overall length of ramp exceeds 9000 mm, provide intermediate landings; and
- where a door swings into ramp landing, ensure length of landing is extended:
 - 600 mm beyond the latch side of the door opening, when the door swings towards the ramp landing (**Figure 6a**); and
 - 300 mm beyond the latch side of door opening, when door swings away from the ramp landing (**Figure 6b**).

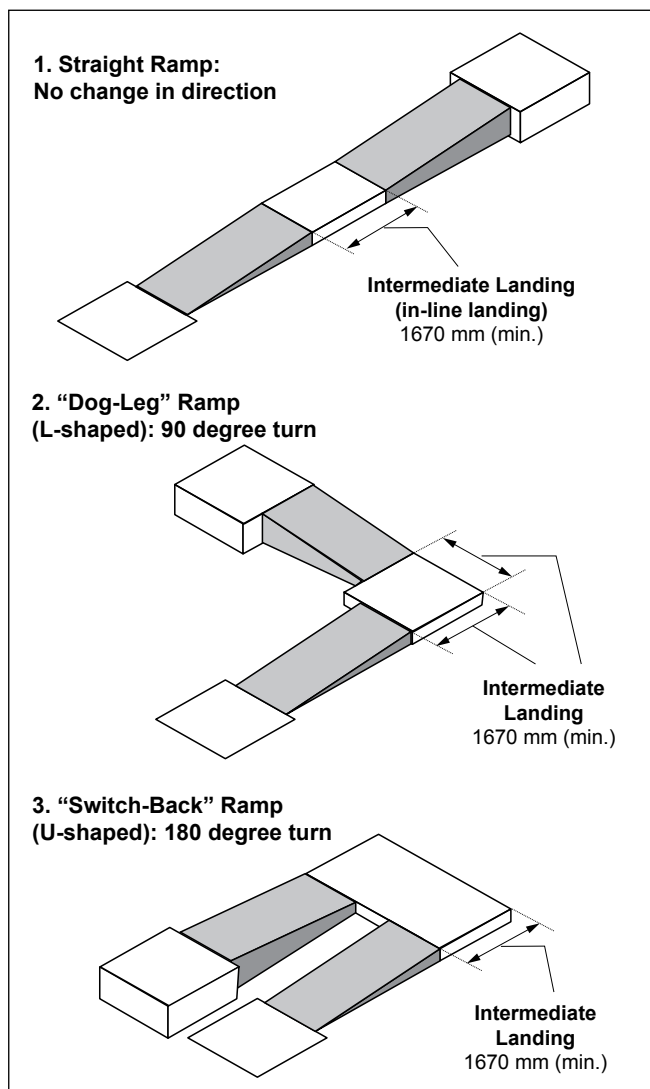

Figure 5: Typical Ramp Configurations

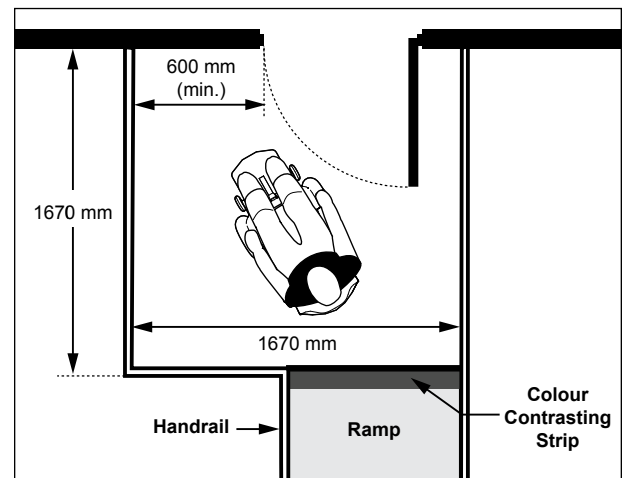

Figure 6a: Door Swings into Ramp Landing - Plan View

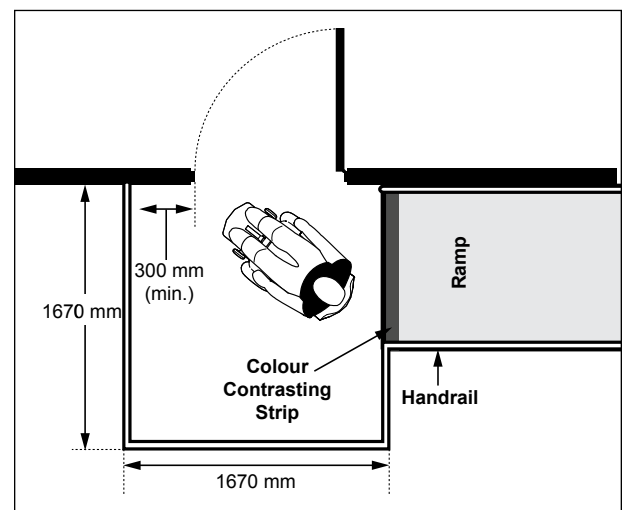

Figure 6b: Door Swings Away From Ramp Landing - Plan View

2.2.3 Handrails and Guards

2.2.3.1 Handrails

- a. mount continuously on both sides of ramp, including landings, at consistent height between 865 mm and 965 mm, measured vertically from the surface of the ramp (**Figure 8**);
- b. provide clear width of 1100 mm (minimum) between handrails and / or any projections into the ramp surface;
- c. provide intermediate handrails where exterior ramps are more than 2200 mm wide, with a maximum of 1650 mm between handrails;
- d. ensure high tonal contrast is provided between handrails and mounting surfaces; and
- e. provide extensions with the following criteria (**Figure 7a & b**):
 - i. extend horizontally 300 mm (minimum) at top and bottom landings;
 - ii. design to return to the guard / rail or wall;
 - iii. ensure handrails are terminated in a manner that will not obstruct pedestrian path of travel or create potential bumping hazards.

Note

Handrails that do not meet the vertical mounting requirements are permitted provided that they are installed in addition to the required handrail.

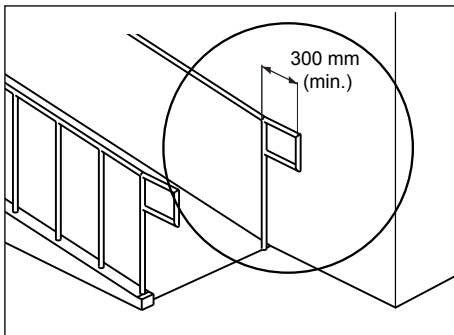

Figure 7a: Handrail Returns to Guard or Rail

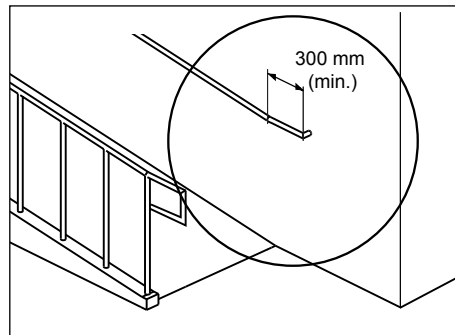

Figure 7b: Handrail Returns to Wall

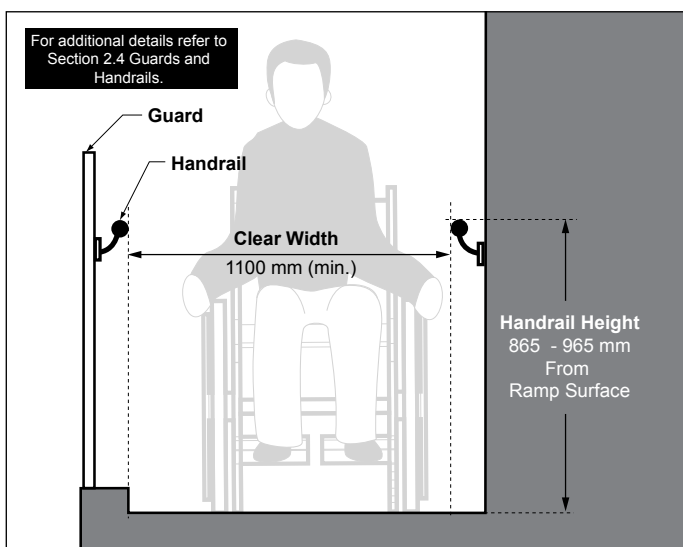

Figure 8: Handrail Design and Features - Section View



Ensure handrail extensions do not obstruct path of travel or create hazards.

2.2.3.2 Guards

Where walls or guards are required:

- a. mount at 1070 mm (minimum) high, measured vertically to the top of the guard from the ramp surface (**Figure 9**); and
- b. ensure that no member, attachment or opening located between 140 mm and 900 mm high above the ramp surface will facilitate climbing.

For ramps under the jurisdiction of the IASR, the ramp must have a wall or guard on both sides. While OBC Section 3.8.3.4 requires a wall or guard on both sides of the ramp, there are conditions in OBC Section 9.8.8.1 that only require a guard if the difference in elevation is more than 600 mm or the adjacent surface within 1200 mm has a slope steeper than 1:2.

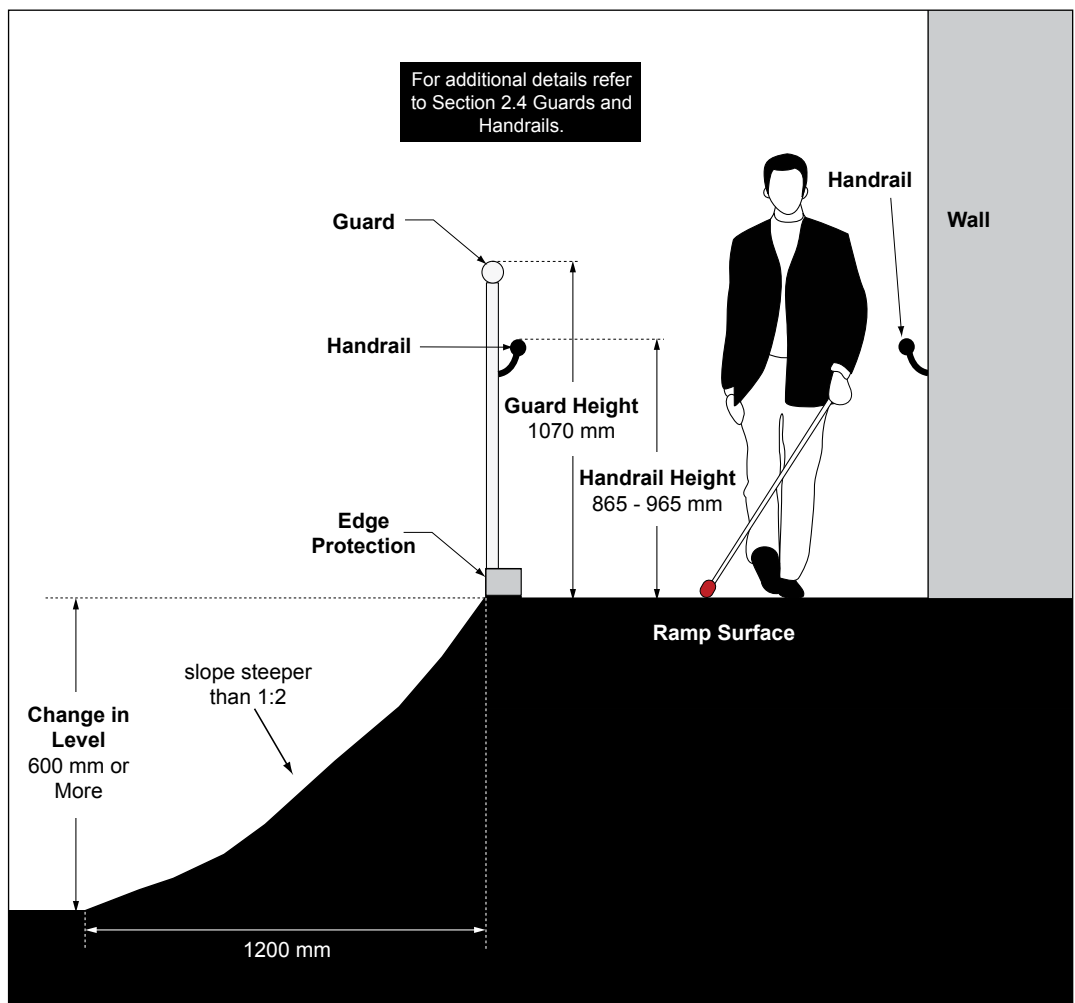

Figure 9: Guard Provision at Ramp - Section View



Application

This section applies to stair systems, where provided for exterior or interior environments.

Additionally, refer to Ontario Building Code (OBC) and Integrated Accessibility Standards Regulation (IASR) requirements for stairs.

Reference

- Sec. 2.1 Ground and Floor Surfaces
- Sec. 2.4 Guards and Handrails
- Sec. 2.7 Tactile Walking Surface Indicators
- Sec. 5.7 Lighting

Exception

Riser height and tread depth standards do not apply to interior exit stairwells.

Note

Marking strips can also be fully integrated within the design of the nosing or finish used on the tread. For exterior stairs, exposed to the elements, and/or stair systems that have a high level of pedestrian traffic, durable marking strips are recommended (e.g., carborundum).

2.3.1 Design Features

- a. ensure surface is stable, firm, slip-resistant and non-glare; and
- b. provide lighting in accordance with Section 5.7 Lighting requirements, as applicable.

2.3.1.1 Treads and Risers

- a. riser height of 125 mm (minimum) to 180 mm (maximum) (**Figure 10**);
- b. tread depth of 280 mm (minimum) to 355 mm (maximum) (**Figure 10**);
- c. stairs must have closed risers; and
- d. ensure uniform riser height and tread depth throughout any stair system.

2.3.1.2 Nosings

- a. ensure no abrupt undersides;
- b. ensure they do not project more than 38 mm over the tread below and are sloped to the riser at an angle greater than 60 degrees to the horizontal;
- c. ensure leading edge is rounded or has a bevelled profile, with a radius of curvature of 13 mm or less (**Figure 10**); and
- d. provide horizontal marking strips:
 - i. 50 mm (+/- 10 mm) deep;
 - ii. at the leading edge of the tread;
 - iii. with a high tonal contrast compared to tread and riser finishes with slip-resistant surface; and
 - iv. extend the full width of the tread.

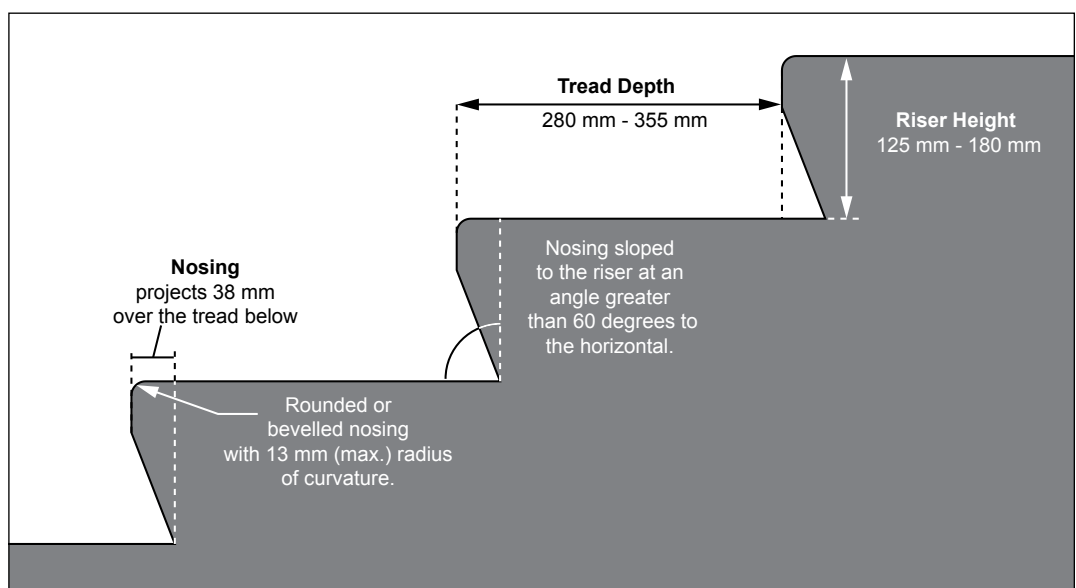

Figure 10: Stair Design Features - Section View

2.3.1.3 Tactile Walking Surface Indicators (TWSIs)

Provide tactile walking surface indicators (TWSIs):

- a. at the top of all flights of stairs starting one tread depth back from the leading edge of the top step; and
- b. at the top step, starting one tread depth back from the leading edge, at the following locations:
 - i. at each landing incorporating an entrance into a stair system;
 - ii. where the regular pattern of a stairway is broken; and
 - iii. where the run of a landing which does not have a continuous handrail is greater than 2100 mm;
- c. with surface depth of 610 mm (minimum), extending the full width of the stair (**Figure 11**).

Note

Tactile walking surface indicators (TWSI) provided at the head of stair systems act as a warning, and tonal contrasted nosings increase the visibility of each step when descending, especially for users with vision loss.

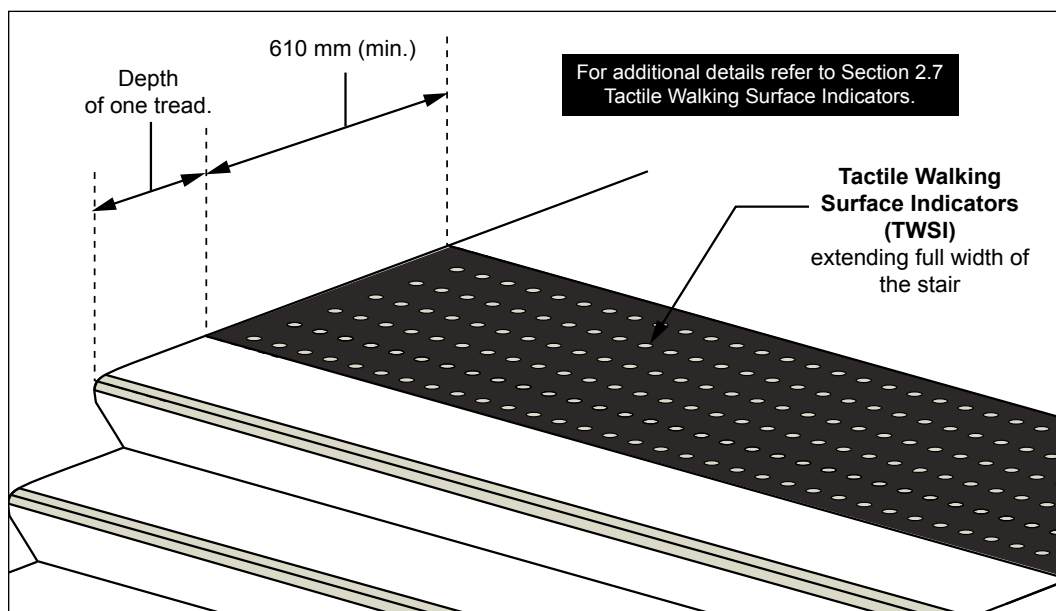

Figure 11: Tactile Walking Surface Indicators (TWSI) at Top of Stairs

2.3.2 Guards and Handrails

2.3.2.1 Guards

Where there is a change in level 600 mm or more in floor level adjacent to stairs, provide guards as follows:

- a. mount 1070 mm (minimum) high, measured vertically to the top of the guard from the stair surface;
- b. provide edge protection; and
- c. ensure that no member, attachment or opening located between 140 mm and 900 mm high above the stair surface will facilitate climbing.

Best Practice

Where stairs are wider than 1800 mm, provide intermediate handrails and ensure clear width between handrails is between 900 mm and 1000 mm.

Note

Handrails ensure a safe descent and climbing of stairs for all users. They are an additional wayfinding guide for users with vision loss when continuous and if a strong tonal contrast is provided.

2.3.2.2 Handrails

- a. provide handrails where stair system contains three or more steps;
- b. mount on both sides of stairs, at a consistent height between 865 mm and 965 mm, measured from leading edge of stair tread (**Figure 12**);
- c. ensure high tonal contrast is provided between handrails and mounting surfaces for improved visibility;
- d. be continuous around landing less than 2100 mm in length from the top of stairs, except where the landing (**Figure 13**):
 - i. is intersected by an alternative accessible route; or
 - ii. has an entry door leading into it;
- e. be continuous on the inside edge of stairs
- f. where stairs are more than 2200 mm wide, provide one or more intermediate handrails with a maximum of 1650 mm between handrails;
- g. provide extensions with the following criteria:
 - i. extend horizontally 300 mm (minimum) at top of flight of stairs, starting immediately above tread nosing;
 - ii. extend diagonally at the slope of the stair flight, for a horizontal distance equal to one tread depth beyond the bottom tread nosing, at bottom of flight of stairs then extend 300 mm parallel to the floor surface;
 - iii. design to return to the wall, guard or floor; and
 - iv. ensure handrails are terminated in a manner that will not obstruct pedestrian travel or create hazards.

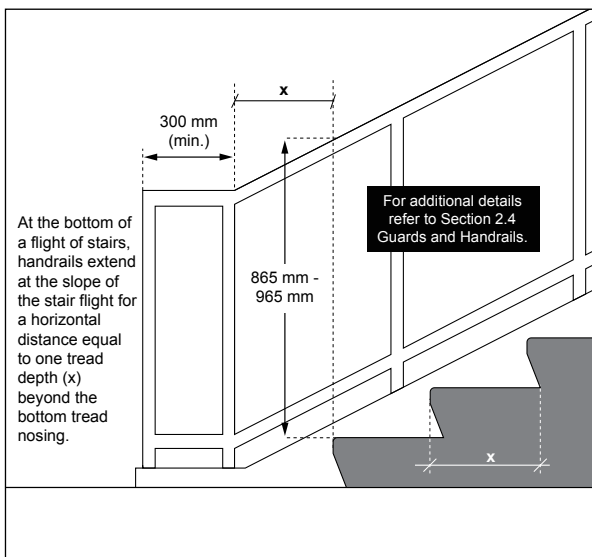

Figure 12: Handrail Extensions at Stairs - Section View

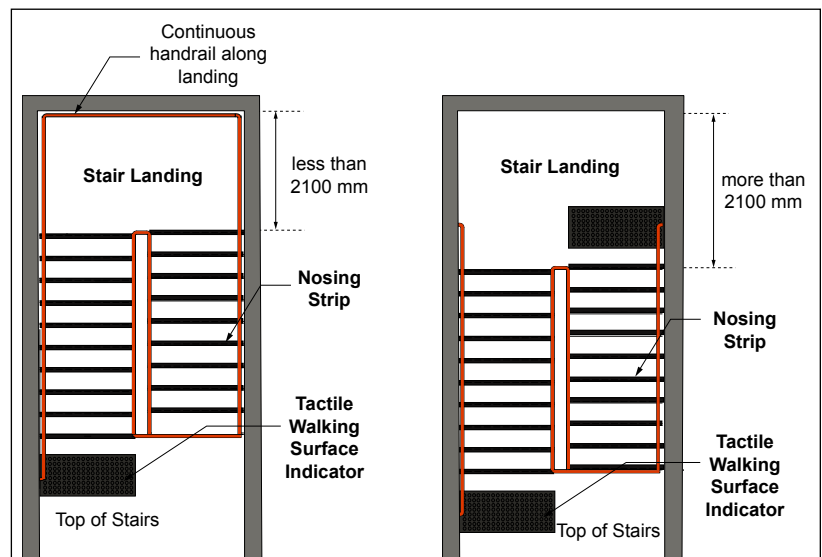



Figure 13: Continuous Handrails at Landings - Plan View



Guards and Handrails

2.4

Application

This section applies to guards and handrails at ramps, stairs and other areas in both interior and exterior environments.

Reference

Sec. 2.2 Ramps

Sec. 2.3 Stairs

Note

Guards are typically provided at ramps, stairs, terraces and elevated viewing platforms in both interior and exterior environments.

Best Practice

In environments used frequently by children, lowered handrails are permitted, provided they are in addition to the required handrails.

2.4.1 Guards

- ensure they comply with the OBC or IASR requirements, as applicable;
- mount at 1070 mm (minimum) high, measured vertically to the top of the guard from the ground / floor surface;
- design to prevent the passage of a sphere with a diameter greater than 100 mm; and
- ensure no member, attachment or opening located between 140 mm and 900 mm high above the level protected by the guard will facilitate climbing.

2.4.2 Handrails

- ensure handrails are continuous with grasping surface, uninterrupted by mounting brackets, newel posts or any other construction elements;
- provide rounded edges, free of abrasive elements;
- provide outside diameter between 30 and 40 mm for circular cross-section, which is preferred (**Figure 14a & 14b**);
- where non-circular cross sections are provided, ensure perimeter dimension of 100 mm (minimum) and 125 mm (maximum), with cross section dimension of 45 mm (maximum);
- provide clearance of 50 mm (minimum) between grasping surface and any adjacent surface (**Figure 14a**);
- where handrails are in a recessed area, ensure clearance of 50 mm (minimum) between handrail surface and adjacent surface with clearance of 450 mm (minimum) above the handrail (**Figure 14b**); and
- be designed and constructed such that handrails and their supports withstand:
 - the loading values obtained from the non-concurrent application of a concentrated load not less than 0.9 kN applied at any point and in any direction; and
 - a uniform load not less than 0.7 kN/m, applied in any direction.

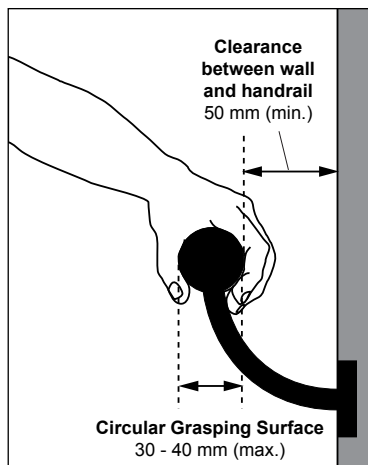

Figure 14a: Handrails on Wall - Section View

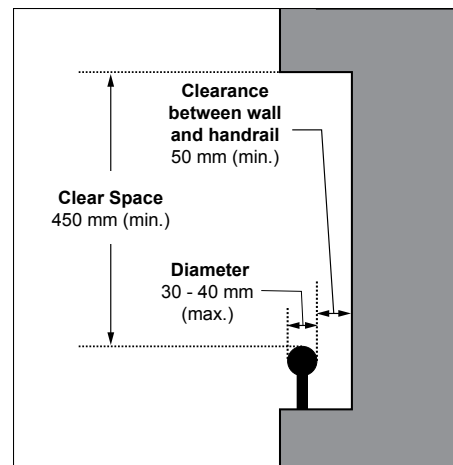

Figure 14b: Handrails in Recessed Area - Section View



Overhanging and Protruding Objects

2.5

Application

This section applies to overhanging and protruding objects throughout and around facilities (interior and exterior environments) to prevent any hazard or obstruction for all users. Protruding objects are typically mounted on walls, ceilings or other locations adjacent to interior and exterior paths of travel.

Reference

- Sec. 2.3 Stairs
- Sec. 2.4 Guards and Handrails
- Sec. 3.3 Exterior Paths of Travel
- Sec. 4.3 Interior Accessible Routes

Best Practice

Wing walls, extending from protruding edge to floor / ground surface, provide cane detection, where protrusion is greater than 100 mm.

2.5.1 Protruding Objects

Where objects protrude along accessible paths of travel:

- ensure the clear width of an accessible path of travel or manoeuvring space is not reduced; and
- ensure objects protruding more than 100 mm from wall have a leading edge that is cane detectable (**Figure 15**).

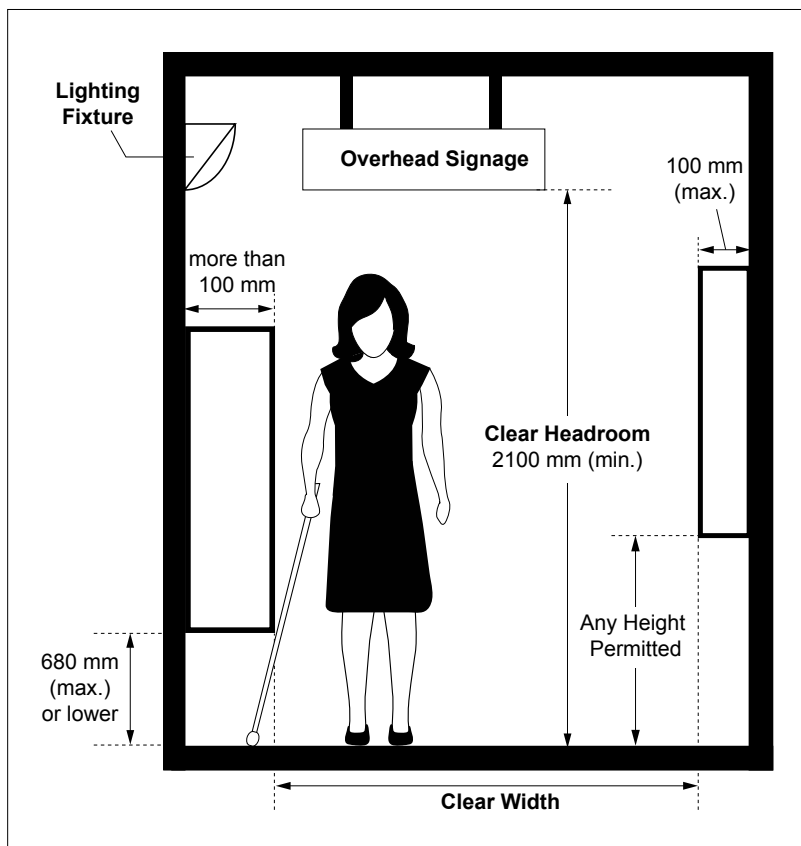

Figure 15: Protruding Objects

Best Practice

Where possible, enclosure at the underside of the stairs for protection is recommended.

Note

Fixed planters or seating are options for providing protection under stairs as long as they are placed within cane detection limits.

2.5.2 Headroom Clearance

- provide 2100 mm (minimum) headroom clearance; and
- where the headroom clearance is less than 2100 mm over a portion of the accessible path of travel, provide a rail or other barrier with leading edge that is cane detectable around the object that is obstructing the headroom clearance (**Figure 16**).

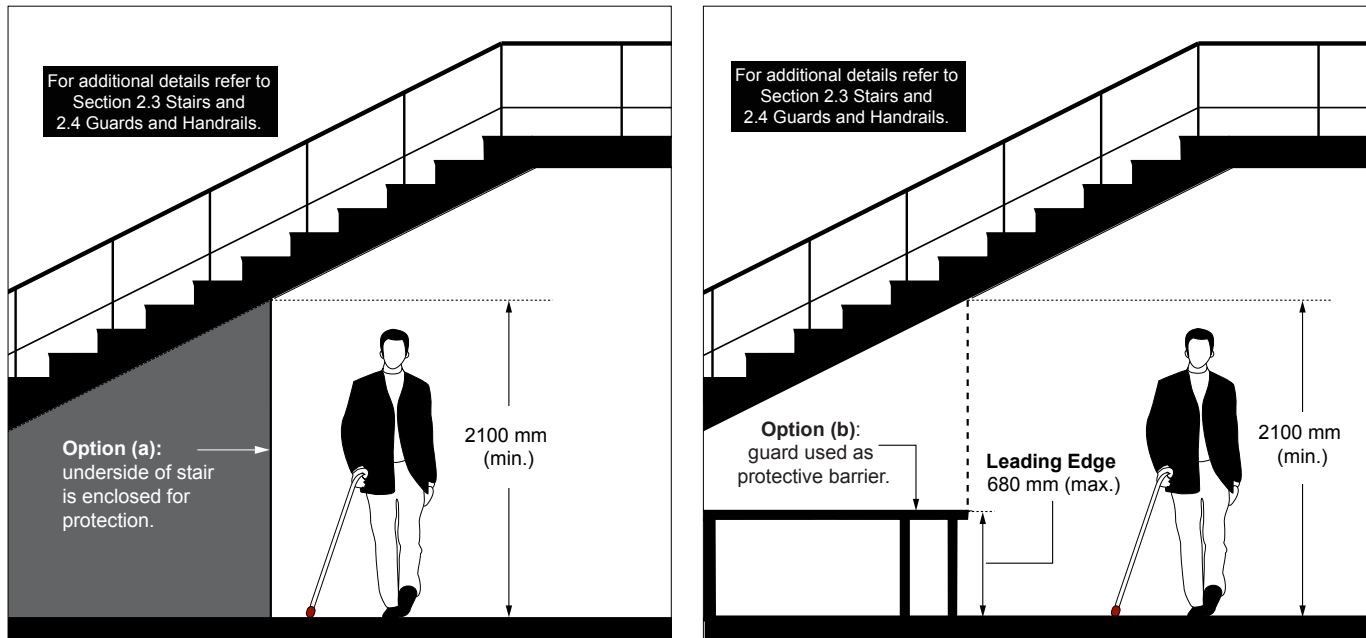

Figure 16: Protection Options Underneath Stairs

2.5.3 Cane Detectable Leading Edge

Where an accessible path of travel is obstructed by overhanging or protruding objects, either the objects themselves must be cane detectable, or a rail or other barrier with a leading edge that is cane detectable must be provided.

- Wall mounted barriers must have a horizontal element at 680 mm high, or lower, to be detectable by people who use white canes (**Figure 15**).
- Floor mounted barriers such as curbs must be at least 75 mm high, unless they include a railing or other component that has a horizontal element at 680 mm high, or lower.



2.6

Application

This section applies to rest areas provided along accessible paths of travel within a facility or throughout exterior environments.

Benches and seating are provided at rest areas and waiting areas for people who may have difficulty with standing or walking for extended periods or limited stamina.

Reference

- Sec. 2.1 Ground and Floor Surfaces
- Sec. 2.10 Seating, Tables and Work Surfaces
- Sec. 3.3 Exterior Paths of Travel
- Sec. 4.3 Interior Accessible Routes
- Sec. 5.7 Lighting

2.6.1 Consultation Requirements

When constructing new or redeveloping existing exterior paths of travel that will be maintained, consultation on the design and placement of rest areas must occur with:

- a. the public and persons with disabilities; and
- b. the City of Ottawa Accessibility Advisory Committee.

2.6.2 Design and Placement

To determine the provision and placement of rest areas, consider the input received through the consultation process and other factors such as available space, property requirements, location of transit stops, and volume of pedestrian traffic. Consider providing rest areas, spaced no more than 30 metres apart, to maximize the usability of the paths of travel for people with reduced stamina.

Where rest areas are provided:

- a. ensure ground and floor surfaces are firm, stable and slip-resistant;
- b. consider providing contrast through ground finish, texture and / or tone to distinguish the rest area from the accessible path of travel;
- c. provide clear floor space of 915 mm wide by 1370 mm long (minimum) (**Figure 17**); and
- d. where seating is provided, ensure seating offers both armrests and backrests.

Note

Where rest areas are located in exterior environments, ensure surface has a slope no greater than 1:50 (2%) to allow suitable drainage, as well as maneuverability for users of mobility aids.

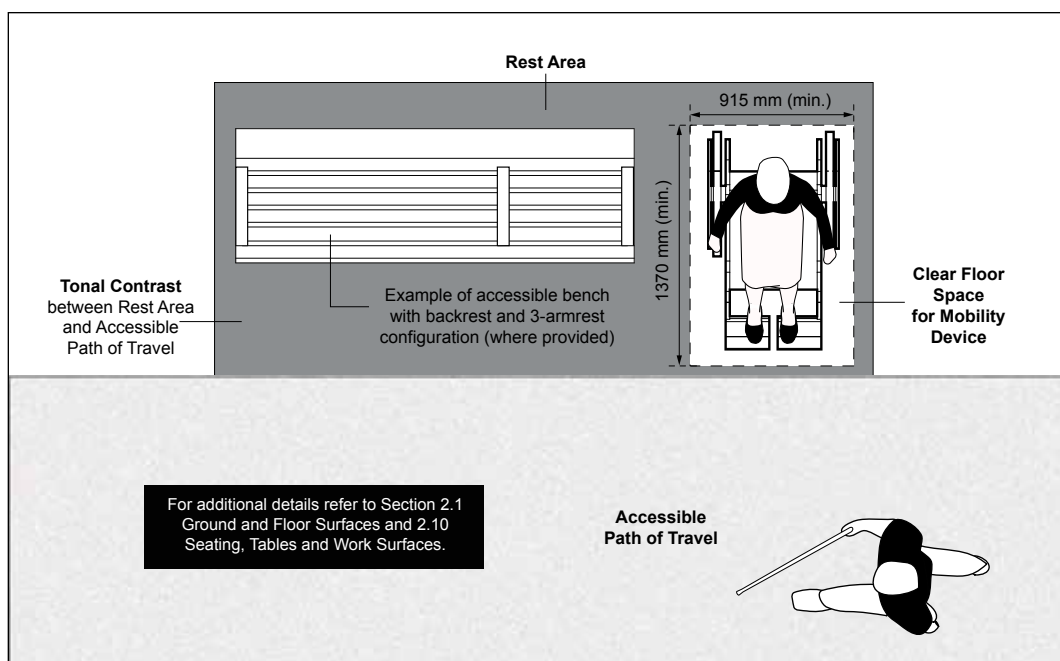

Figure 17: Rest Area - Plan View

Tactile Walking Surface Indicators

2.7

Application

Tactile walking surface indicators (TWSI) means a standardized surface, detectable underfoot or by a long white cane, to assist people with low vision or blindness by alerting or guiding them (*Illustrated Technical Guide to the Accessibility Standard for the Design of Public Spaces, GAATES, p201*). Typical locations where TWSIs are required include:

- at curb ramps and depressed curbs;
- where walking surfaces between pedestrian and vehicular areas are not separated by curbs; and
- at stairs.

Both cast in place (e.g., embedded within concrete) and surface applied TWSI systems are available for new construction and retrofits depending on the mounting surface and application. Surface applied systems require beveled edges to prevent potential tripping hazards.

Reference

- Sec. 2.3 Stairs
- Sec. 3.3 Exterior Paths of Travel
- Sec. 3.4 Curb Ramps and Depressed Curbs
- Sec. 4.3 Interior Accessible Routes
- Sec. 6.7 Recreational and Community Facilities
- Sec. 6.12 Elevated Platforms or Stages
- Sec. 6.20 Public Transit

Note

TWSIs can also be referred to as detectable warning surfaces.

2.7.1 Design Features

Provide tactile walking surface indicators (TWSIs) with:

- a. raised tactile profile;
- b. truncated domes (e.g., circular and flat-topped domes);
- c. slip-resistant and non-glare surfaces;
- d. a high tonal contrast between the TWSI and the adjacent surfaces; and
- e. edges beveled or level with surrounding surface (e.g., height of 3 mm or less).

2.7.2 Truncated Dome Specifications

- a. ensure flat-topped domes are 5 mm (+/- 1 mm) high (**Figure 18**);
- b. ensure the top of flat-topped domes are between 12 to 25 mm diameter;
- c. ensure diameter of the lower base of the flat-topped domes are 10 mm (+/- 1 mm) more than the diameter of the top (e.g., a base diameter of 21 to 36 mm is typical);
- d. ensure domes are arranged in a square grid; and
- e. ensure spacing between adjacent flat-topped domes is adjusted depending on the size of the domes, as identified in **Table 1**.

Note

Simply applying tonal contrasted finish to a concrete surface does not provide appropriate tactile profile for detection by foot or cane.

For more information on requirements for truncated domes, refer to: ISO 23599:2012 "Assistive products for blind and vision-impaired persons -- Tactile walking surface indicators."

Table 1: Truncated Dome Spacing Requirements

Top Diameter of Flat Topped Domes (mm)	Spacing Between the Centres of Adjacent Domes (mm)
12	42 to 61
15	45 to 63
18	48 to 65
20	50 to 68
25	55 to 70

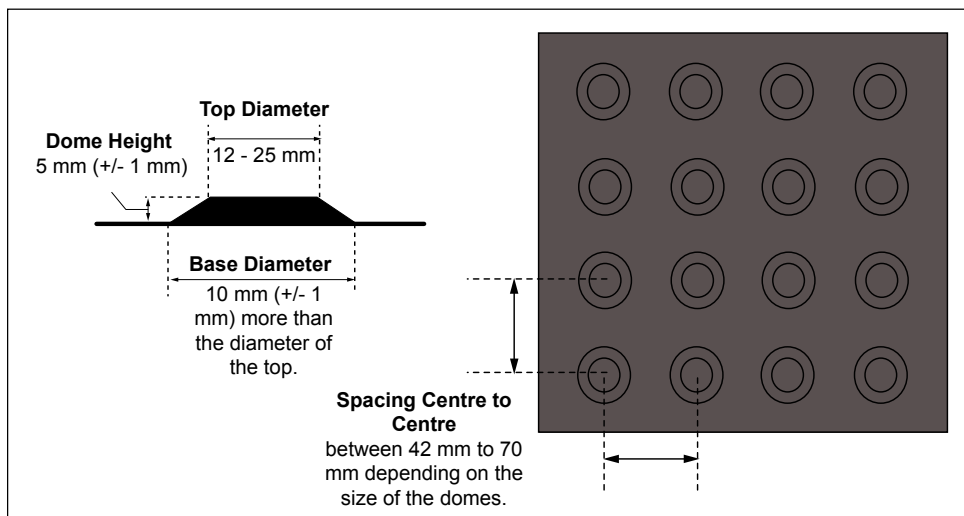

Figure 18: Truncated Dome Specification



2.8

Application

This section applies to drinking fountains where provided throughout interior and exterior environments.

Reference

Sec. 3.3 Exterior Paths of Travel

Sec. 4.3 Interior Accessible Routes

2.8.1 Design and Layout

Where drinking fountains are provided:

- ensure at least one drinking fountain is accessible to all users, including lowered units for people using mobility aids, people of short stature, children, others who may have trouble bending and persons who have limited manual strength or dexterity;
- where only one drinking fountain is provided, ensure it is an accessible, lowered unit;
- ensure fountains are located adjacent to an accessible route, recessed or with a leading edge that is cane detectable at 680 mm (maximum) high, if they protrude into an accessible route; and
- ensure drinking fountain fixtures provide a high tonal contrast with surroundings for easy identification.

Best Practice

The provision of two drinking fountains, one at lowered, accessible height and the other at standing height meets the needs of diverse users.

Locating drinking fountains adjacent to the accessible route or recessing it in an alcove is preferred as it prevents potential bumping hazard.

2.8.2 Clear Floor Space Requirements and Approach

- provide clear floor space of 915 mm wide by 1370 mm deep (minimum) for forward approach (**Figure 19**);
- provide clear floor space of 1525 mm wide by 915 mm deep (minimum) for side approach (**Figure 19**);
- ensure one fully unobstructed side adjoins an accessible route or adjoins another clear floor area; and
- ensure clear floor space does not overlap the minimum space of the accessible route used to access the drinking fountain.

Note

For standing use, spouts are located between 965 and 1090 mm above floor.

The space beneath the drinking fountain may be included as part of the clear floor area or turning space, provided that appropriate toe and knee clearances are available for a forward or parallel approach to an unrecessed or partially recessed drinking fountain.

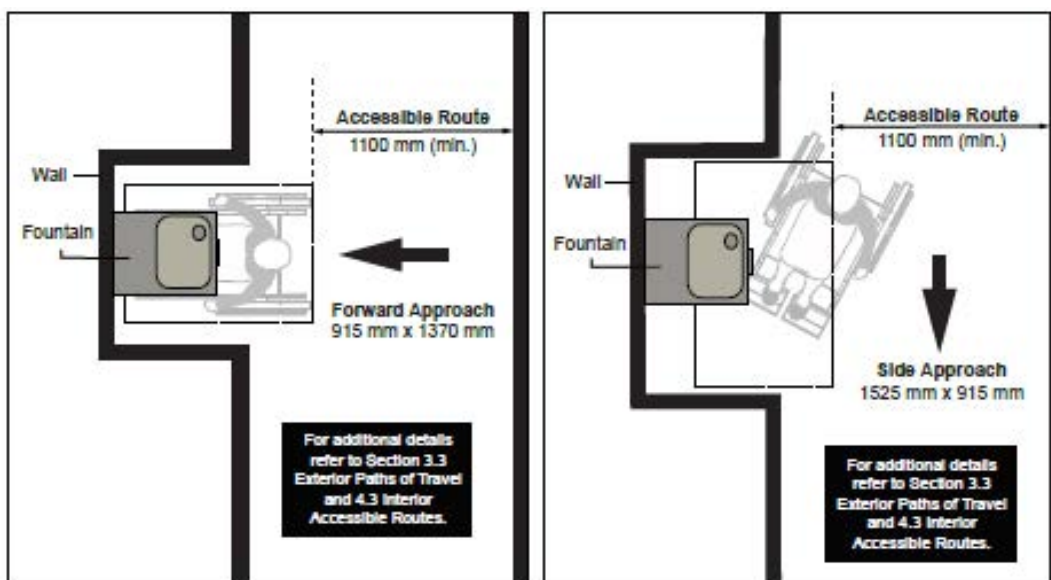

Figure 19: Clear Floor Space Requirements and Approach at Recessed Drinking Fountain - Plan View

Best Practice

Automatic or hands free operating controls are preferred.

Note

The purpose of requiring the drinking fountain to have a flow of water of 100 mm high (minimum) is so that a cup can be inserted under the flow of water for users who cannot use the drinking fountain.

2.8.3 Knee and Toe Clearances

Where accessible, lowered drinking fountains are provided:

- ensure clear knee space under the fountain is 760 mm wide by 200 mm deep at 735 mm high (minimum) above the floor (**Figure 20**);
- ensure clear toe space under the fountain is 350 mm above the floor from a point of 300 mm back from the front edge to the wall; and
- ensure the depth at the base of the fountain is 700 mm (minimum).

2.8.4 Operating Controls

Ensure fountain operating controls are:

- not foot-operated;
- located at or near the front of the drinking fountain (**Figure 20**); and
- operable with one hand, requiring a force of no more than 22 Newtons to operate without turning / twisting of the wrist or pinching of the fingers.

2.8.5 Water Spout

- mount no higher than 915 mm above the finished floor for accessible units;
- mount 125 mm (maximum) from the front of the drinking fountain, including bumpers, and 380 mm (minimum) from the vertical support;
- ensure water flows 100 mm high (minimum); and
- ensure water flows at a vertical angle of:
 - 30 degrees maximum, where spouts are located less than 75 mm from the front of the unit; or
 - 15 degrees maximum, where water spouts are located between 75 mm and 125 mm from the front of the unit.

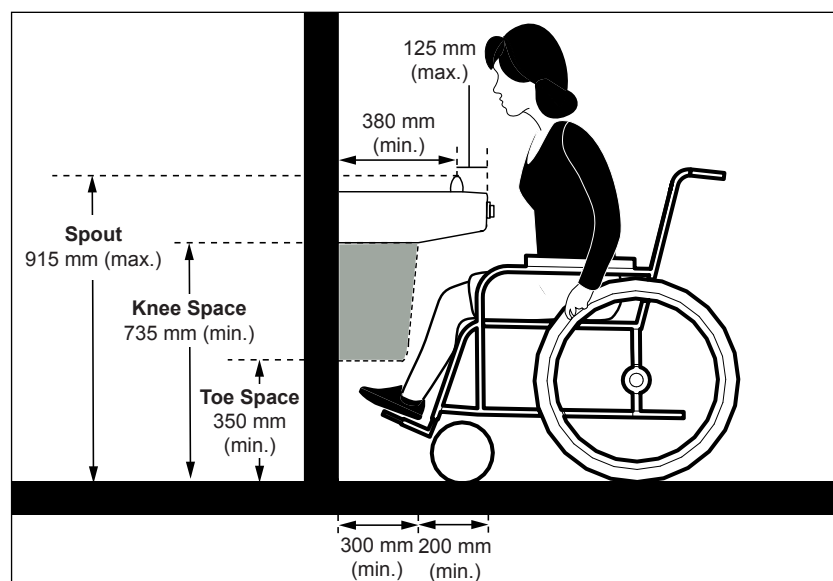

Figure 20: Drinking Fountain Design and Layout - Elevation View



Application

This section applies to public telephones, which include coin operated, coin-less, and courtesy phones, located in both exterior and interior environments.

Reference

- Sec. 2.10 Seating, Tables and Work Surfaces
- Sec. 5.1 Controls and Operating Mechanisms
- Sec. 5.7 Lighting
- Sec. 5.8 Signage and Wayfinding

Note

Public telephones can vary in design and style. Overall configuration is beyond the scope of these Standards and is typically the responsibility of the telephone service provider.

Best Practice

Where more than four public telephones are provided on an accessible floor level, equip one phone with a fixed TTY device, mounted below the phone without minimizing required knee space height for users of mobility aids.

2.9.1 Provision

Where public telephones are provided, provide at least one accessible telephone unit on each accessible floor level as identified in **Table 2**.

Table 2: Minimum Number of Accessible Telephones Required

Total Number of Telephone Units Located on Floor	Number of Telephone Units Required to be Accessible
1 or more single units	1 per floor
1 bank	1 per floor
2 or more banks	1 per bank

2.9.2 Design and Layout

- a. provide directional signage to accessible public telephone location, if phone is hidden from view or mounted in a recessed area;
- b. mark with International Symbols of Accessibility and Hearing Loss, for accessibility features provided;
- c. provide clear floor space in front of accessible telephone unit (e.g., can be wall-mounted or hung in an enclosure) of **(Figure 21)**:
 - i. 915 mm wide by 1370 mm depth (minimum) for a forward approach ; and
 - ii. 1525 mm wide x 915 mm depth (minimum) for a side approach;
- d. ensure they are located adjacent to an accessible route, recessed or with a leading edge that is cane detectable at 680 mm (maximum) high, if they protrude into an accessible route;
- e. ensure overhead clearance of 2100 mm (minimum);
- f. where seating is provided in floor space, ensure it can be moved to accommodate users of mobility aids and people who prefer to stand;
- g. where stall or booth is provided for privacy and acoustics, provide sound-absorbing surfaces and ensure all required clearances are provided (e.g., floor space); and
- h. provide lighting in accordance with Section 5.7 Lighting requirements, as applicable.

2.9.3 Telephone Operating Controls

- provide push button controls with large size numbers;
- ensure a high tonal contrast is provided between button and background, as well as numbering;
- ensure controls have a matte finish;
- mount operating controls, such as coin and card slots, push buttons and dispensers, at 1200 mm (maximum) from floor level (**Figure 22**);
- ensure maximum reach to all operating controls is 485 mm from front edge of phone cabinet or shelf;
- provide cord for telephone handset with length of 735 mm (minimum); and
- equip with adjustable volume controls for users with hearing loss.

Best Practice

All accessible public telephones and a minimum of 25% of the total number of telephones provided should be equipped with adjustable volume control.

Note

It is the responsibility of the phone service provider to ensure all telephone features comply with CAN / CSA-T515 standard.

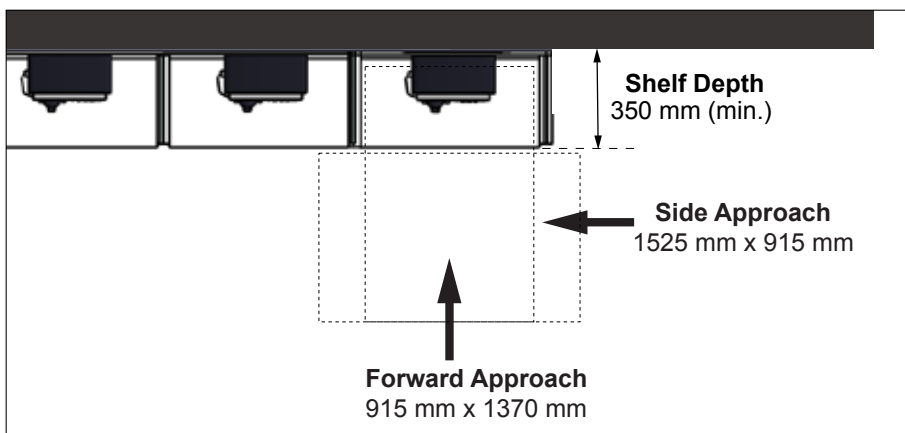

Figure 21: Clear Floor Space Requirements at Accessible Public Telephone

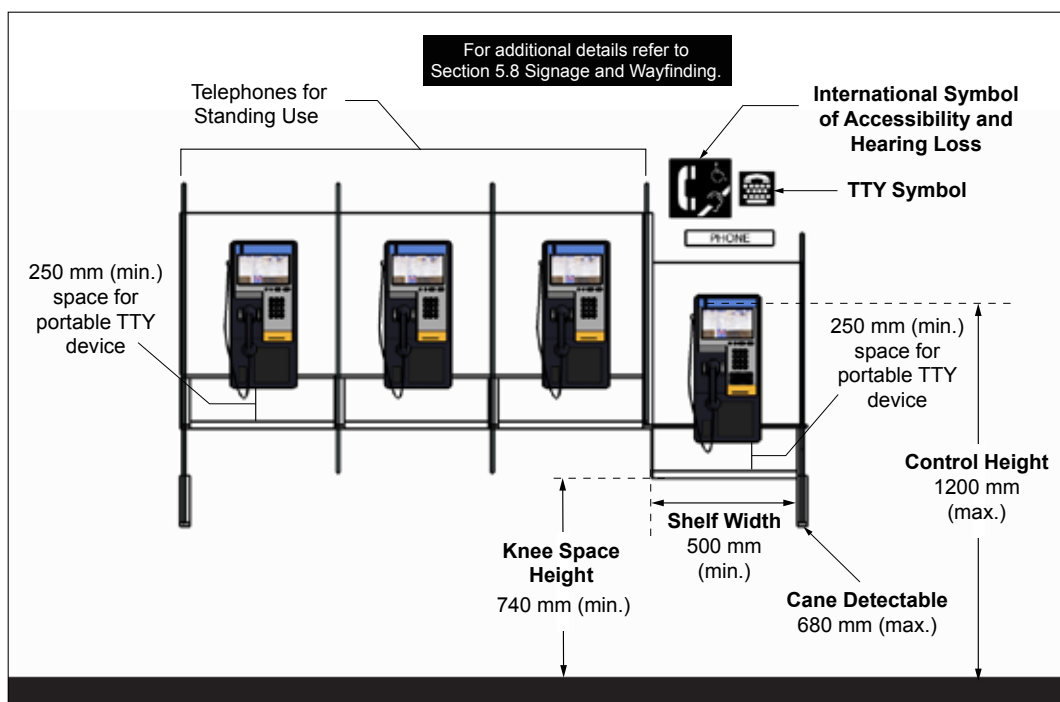

Figure 22: Public Telephone Provisions and Layout

2.9.4 Shelves and Counters

Where more than one telephone is provided for public use, provide a built-in shelf or counter underneath at least one telephone (**Figure 22**):

- ensure shelf or counter is level;
- 500 mm wide by 350 mm deep (minimum);
- mount top surface between 775 and 875 mm high above floor;
- ensure knee clearance is 740 mm high (minimum); and
- ensure a clear space of 250 mm (minimum) high between top of shelf and lower edge of phone equipment.

2.9.5 Text Telephones (TTYs)

Where fixed or portable teletypewriter (TTY) devices or connections are available:

- provide signage with the International Symbols of Accessibility and Hearing Loss and symbol for TTY, to identify its location;
- provide adaptable controls to allow portable TTY connections, including adjacent electrical outlet where telephones are provided specifically to address the needs of users with hearing loss; and
- provide long cord on telephone handset to allow connection to text telephone (TTY), if acoustic coupler is used.



Examples of both fixed and portable Teletypewriters (TTYs).



Seating, Tables and Work Surfaces

2.10

Application

This section applies to site and facility furniture, provided in both exterior and interior environments which typically includes, but is not limited to seating (e.g., benches) tables and work surfaces. Some common locations, where site and facility furniture can be found are:

- rest areas and accessible routes;
- dining facilities;
- outdoor public use eating areas;
- waiting areas;
- lobbies; and
- office environments.

Reference

- Sec. 6.2 Meeting and Multi-Purpose Rooms
- Sec. 6.4 Cafeteria and Dining Facilities
- Sec. 6.5 Kitchens and Kitchenettes
- Sec. 6.6 Libraries
- Sec. 6.10 Service Counters
- Sec. 6.11 Waiting and Queuing Areas
- Sec. 6.14 Outdoor Public Use Eating Areas

Note

Furniture provisions should be reviewed on a case by case basis, specific to facility type and occupancy. Some locations may require more exterior site furnishings if high level of public traffic and use is expected.

Best Practice

Where multiple benches are provided, consider option of some benches oriented to face each other where possible. This arrangement allows people to see each other, which is beneficial for people with hearing and communication disabilities to facilitate interaction. Also consider different configurations for armrests and backrests.

Note

Where only one bench is provided, ensure it is accessible with a three arm rest configuration: one provided at each end and one within the middle.

Where an arm rest is provided in the middle of the seat, ensure it is located one seat-width from an arm at the end of the bench. For example a three-seat bench would have the middle arm at 1/3 of the width whereas a two-seat bench would have the middle arm at 1/2 of the width.

2.10.1 Benches and Seats

Provision of benches and seats are typically recommended for people who may have difficulty with standing or walking for extended periods, limited stamina, or for users of mobility aids.

For accessible benches and seating provided in both interior and exterior environments:

- ensure seat height is between 450 and 500 mm above finished floor / ground (**Figure 23**);
- ensure seat depth is between 330 and 510 mm;
- provide back support, extending 320 mm (minimum) above the seat surface, or affix the seat to a wall;
- provide at least one (1) arm rest at a height between 220 and 300 mm from the seat for additional support;
- ensure bench is stable at all times; and
- ensure seating surfaces provide high tonal contrast with surroundings to enhance visibility.

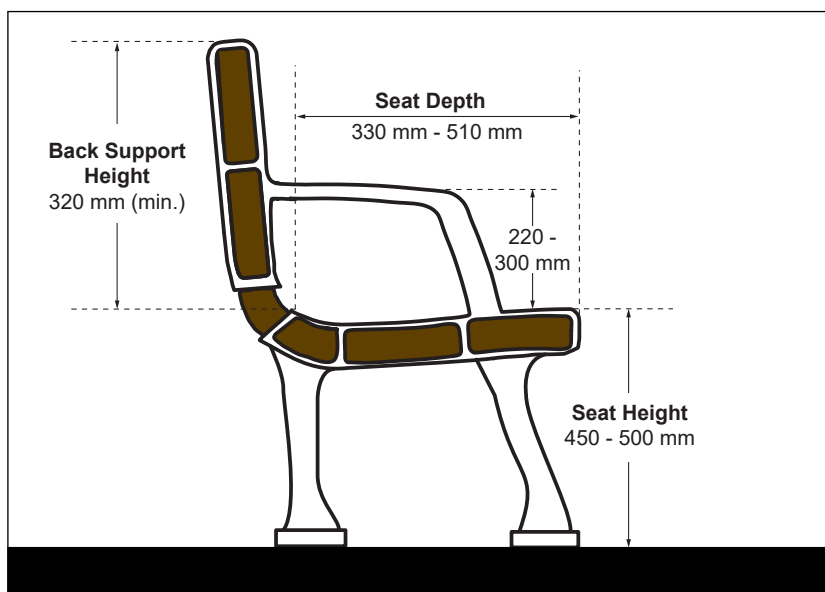

Figure 23: Typical Accessible Bench Dimensions - Section View

2.10.2 Tables and Work Surfaces

- ensure top surface is between 730 mm and 865 mm high (**Figure 24a**);
- provide clear knee space of:
 - 760 mm wide (minimum);
 - 480 mm (minimum) deep by 685 mm high (minimum);
- where toe clearance is required based on table design, ensure toe space is 350 mm (minimum) high by 230 mm (minimum) deep;
- ensure top surface and edges provide a high contrast with adjacent surroundings to enhance visibility; and
- ensure clear floor space provided at table and work surfaces for users of mobility aids is (**Figure 24b**):
 - 760 mm wide by 1370 mm deep (minimum), of which 480 mm (maximum) may be under the table for forward approach; or
 - 1525 mm wide by 915 mm deep (minimum) for a side approach.

Best Practice

Provide a clear floor space or ground surface with turning diameter of 1675 mm, to allow both side and front approach by users of larger wheeled mobility aids, such as powered scooters and wheelchairs.

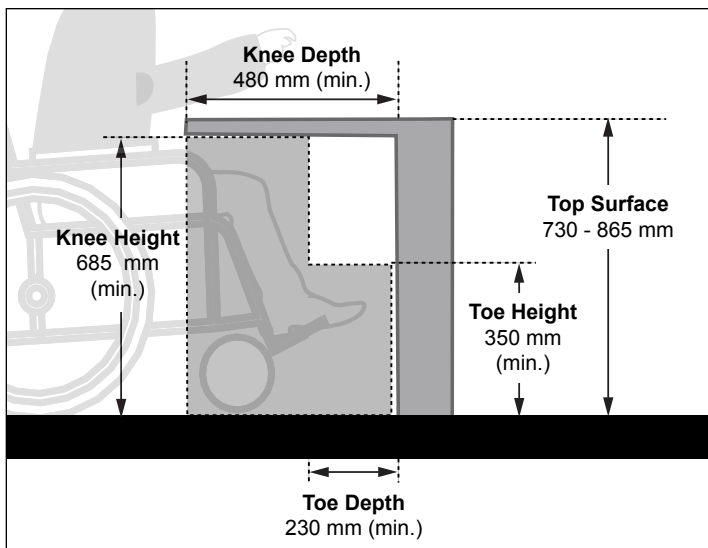

Figure 24a: Knee and Toe Clearances - Elevation View

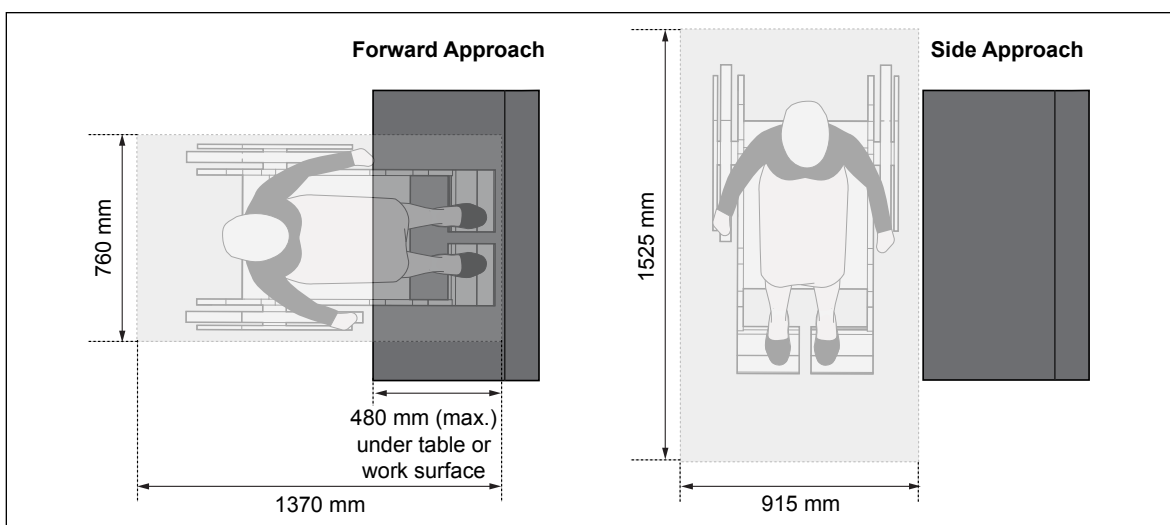

Figure 24b: Clear Floor Space Requirements and Approach at Tables and Work Surfaces - Plan View



Accessibility During Construction

2.11

Application

This section applies when pedestrians will be affected by construction of new or redevelopment of existing City-owned or leased buildings, infrastructure and elements. This includes construction within the right-of-way as well as City of Ottawa buildings, parks, pathways and other public spaces. Pedestrians include residents, employees and visitors.

2.11.1 Construction Site Pedestrian Control Plan

The Contractor undertaking the construction shall prepare a Construction Site Pedestrian Control Plan which will ensure the provision of a safe and accessible path of travel for all pedestrians through and/or around the construction site. The plan shall ensure that pedestrians with disabilities, as well as those with increased mobility needs (parents with strollers and/or young children, elderly pedestrians using canes, walkers, or wheelchairs, etc.), will be accommodated either through or around the construction site.

2.11.2 Detailed Requirements

For construction within the right-of-way, the standard requirements of Special Provision – Item Specific F-1013 Construction Site Pedestrian Control Plan (S.P. F-1013 most recent version) apply, along with any project-specific requirements based on the unique characteristics of the project, if applicable. References to payment items and the contract administrator’s role within S.P. F-1013 only apply to projects tendered by the City. For projects tendered or administered by other parties, the role of the contract administrator may be played by other parties in consultation with the City of Ottawa Traffic Management Unit.

For construction affecting City of Ottawa buildings, parks, pathways and other public spaces the requirements and concepts presented in S.P. F-1013 shall apply, adapted to suit the type of project, along with any project-specific requirements based on the unique characteristics of the project, if applicable.

2.11.3 Sample of S.P. F-1013 Construction Site Pedestrian Control Plan

Refer to a sample of Construction Site Pedestrian Control Plan (S.P. No: F-1013), March 2015 version, as follows.

S.P. No: F-1013

Date: March 2015

Page: 1 of 5

CONSTRUCTION SITE PEDESTRIAN CONTROL PLAN

1.0 Scope

The Scope of the work addressed in this specification “Construction Site Pedestrian Control Plan” shall include the preparation and submission of a Construction Site Pedestrian Control Plan (CSPCP) as outlined in this specification and in Special Provision – General D-005, along with all labour, equipment, and material required to implement the CSPCP.

The Construction Site Pedestrian Control Plan shall ensure the provision of a safe and accessible path of travel for all pedestrians through and/or around the construction site. The plan shall ensure that pedestrians with disabilities, as well as those with increased mobility needs (parents with strollers and/or young children, elderly pedestrians using canes, walkers, or wheelchairs, etc.), shall be accommodated either through or around the construction site. The scope of the work addressed in CSPCP will include temporary pedestrian signing; directional signing; maintenance of sidewalk; relocation, maintenance, and removal of pedestrian barriers; and all necessary delineation or any other measures to provide a safe environment for pedestrians.

Staging of the Work

The work shall be staged in a manner consistent with the staging of the Contract and in accordance with the implementation of the traffic control measures as stipulated in the Contractor’s Traffic Control Plan. When determining the staging of the Contract, the Contractor shall maintain existing sidewalk facilities for as long as possible. Removal of any existing sidewalk facilities, or portion thereof, shall not be permitted until permission has been granted by the Contract Administrator.

Pedestrian Facilities

Regardless of whether or not there is an existing sidewalk within the right-of-way, a minimum 1.5m wide pedestrian facility shall be provided along at least one side of the corridor at all times. The facility shall include a free and unobstructed hard surfaced pedestrian surface acceptable for use by all pedestrians, including those with disabilities, and shall include pedestrian access to all buildings and street crossings. The facility shall be maintained clean and in a good state of repair to the satisfaction of the Contract Administrator, through or around the construction site at all times. The 1.5m width shall not be reduced by protruding objects. If overhead works are required a 2.1m clear headroom shall be provided along the entire 1.5m width.

Any change of level which is over 13mm height must be provided with a smooth, non-tripping transition.

\\Section F\General\F-1013 – March 2, 2015

S.P. No: F-1013

Date: March 2015

Page: 2 of 5

CONSTRUCTION SITE PEDESTRIAN CONTROL PLAN

Unless otherwise stated in the Contract, hard surface shall mean evenly graded temporary hot mix asphalt. For weather conditions where hot mix asphalt is not readily available, firm level, compacted stone dust shall be permitted. For temporary conditions less than 5 days, regardless of weather conditions, firm, level, compacted Granular 'A' or stone dust shall be permitted.

If the Contractor deems it necessary to install a temporary pedestrian facility in an area of the Contract which will not be reinstated as part of the planned works, then it is the Contractor's responsibility to reinstate that area, to existing or better conditions, upon the removal of the temporary facility. No additional payment for this reinstatement will be considered.

If a temporary closure of an entrance to a building is required, the Contractor shall advise the Contract Administrator at least 3 working days in advance. The Contract Administrator shall arrange and the Contractor shall accompany the Contract Administrator at a meeting or meetings with the entrance owner. The Contractor shall provide his detailed schedule for completion of the various items of work opposite each property and co-ordinate his operations with the requirement of the property owner. No work shall be undertaken until the Contract Administrator has given consent to close the entrance. All pedestrian accesses to buildings must be provided once the construction for the day is completed. No claims for additional costs resulting from any delays in arranging a temporary closure will be considered.

Boundary Protection

Erection of temporary barriers or fencing is required to separate pedestrians from construction operations or hazards to the satisfaction of the Contract Administrator. The temporary barriers or fencing shall include a cane detectable boundary protection, with edge or barrier at least 75mm high above the ground surface.

Signage Requirements

Where pedestrians must be detoured, either to the other side of the street, or around the construction site, the Contractor shall install bilingual signage at both the near side and the far side of the intersection preceding the detour.

Choice of Pedestrian or Vehicle Detour

If the Contractor determines that due to the technical or safety requirements of underground work or utility relocations, or lack of available property within the right-of-

S.P. No: F-1013

Date: March 2015

Page: 3 of 5

CONSTRUCTION SITE PEDESTRIAN CONTROL PLAN

way, it is not possible to maintain a minimum 1.5m pedestrian facility through the construction site, they shall advise the Contract Administrator at least 2 weeks in advance. The Contract Administrator shall determine whether pedestrians and/or vehicles shall be detoured around the construction site.

2.0 Submissions, Monitoring, and Repair

Two (2) weeks prior to commencing construction, the Contractor shall submit the Construction Site Pedestrian Control Plan to the Contract Administrator. The Contractor acknowledges that revisions to the CSPCP may be necessary, in consultation with the City, where it concerns accessibility, public safety and mobility.

The Contractor may choose whether to include all details related to the CSPCP into the Traffic Control Plan, or submit additional details on separate CSPCP plans.

The Contractor shall ensure that all workers, including sub-contractors, in the Working Area are aware of the importance of the CSPCP measures.

The Contractor shall be required to review and modify the CSPCP for errors, omissions, deficiencies, or because of any new obstacles to accessibility are identified and not previously addressed within the document.

The condition of all pedestrian control materials and/or devices shall be maintained for the duration of the contract.

The Contractor shall immediately repair, replace or otherwise make good the practice deemed unsafe or non-compliant when the owner (or his delegated authority) makes the Contractor aware of any violation of the CSPCP. Should the Contractor disagree, the City of Ottawa Corporate Accessibility Unit will be consulted to provide clarification of the observed deficiency.

It is the responsibility of the Contractor to ensure that all necessary training has been provided prior to commencement of the work.

The City of Ottawa through the Project Manager will accept the submission of the CSPCP, and review it to identify any errors, omissions, or improvements that the City staff is aware of, as it relates to maintaining public safety and mobility.

The acceptance and review of the CSPCP by the City will make no representation and/or warranty that the document is accurate, complete, or compliant with all applicable legislation. Any errors, omissions or deficiencies within the CSPCP will

\\Section F\General\F-1013 – March 2, 2015

S.P. No: F-1013

Date: March 2015

Page: 4 of 5

CONSTRUCTION SITE PEDESTRIAN CONTROL PLAN

remain the sole responsibility of the Contractor. The contract shall not commence, until the City has reviewed the CSPCP to the satisfaction of the City's Contract Administrator, and the Contractor has addressed all comments

The Contract Administrator reserves the right to ask for revisions to the CSPCP at submission time, or reject it if the Plan does not meet the Contract language. In addition, the Contract Administrator reserves the right to instruct the Contractor to revise it at any time during the Contractor's execution of the plan, when the Contract Administrator finds that the Contractor is not providing the commitments shown in the original CSPCP submission, or the Contractor's CSPCP proves to be insufficient to address the field conditions.

3.0 Basis of Payment

Payment at the contract Lump Sum Price for the item "Construction Site Pedestrian Control Plan" shall be full compensation for the research, preparation and implementation of the CSPCP, and shall include all labour, equipment and material to supply, and maintain all pedestrian control measures detailed therein. This payment includes supply, installation, monitoring, operation, maintenance and removal of all required pedestrian control devices.

Payment shall be full compensation for all labour, equipment, and material required to do the work.

If they are included in the schedule of prices, the following items shall be considered for separate payment:

- Pedestrian Barriers
- Granular 'A' or Stone Dust for temporary pedestrian facility
- Temporary hot mix asphalt for temporary pedestrian facility

For each of these items, no area shall be measured for payment more than once per each linear side of the construction site corridor. For example, if the Contractor stages the work such that they use temporary hot mix asphalt to construct a temporary pedestrian facility three (3) separate times along one side of the street, and not at all along the opposite side of the street, the maximum payment shall be for the construction of two (2) of the temporary facilities.

Note to designer: If it seems necessary, due to the anticipated staging required to construction the work, to use any of the above three items, then insert into the

S.P. No: F-1013

Date: March 2015

Page: 5 of 5

CONSTRUCTION SITE PEDESTRIAN CONTROL PLAN

schedule of prices and use quantity for payment based on once per each linear side of the corridor.

Payment of the CSPCP shall be based upon the following schedule:

25% upon the satisfactory submission of the CSPCP, supply and installation of the pedestrian control measures;

60% pro-rated into equal payments over the term of the contract; and,

15% upon the removal of the pedestrian control measures.

This payment schedule may only be modified as agreed upon in writing between the Contractor and the Contract Administrator.

Warrant: On all contracts.

Exterior Environments

3.0

Table of Contents

3.1	Parking.....	61
3.2	Passenger Loading Zones.....	66
3.3	Exterior Paths of Travel.....	69
3.4	Curb Ramps and Depressed Curbs	74
3.5	Accessible Pedestrian Signals	79

[Page intentionally left blank for printing purposes.]



3.1

Application

This section applies to accessible parking spaces provided for the following types of exterior or interior parking facilities:

- parking garages or related structures (e.g., above or below grade);
- surface parking; and
- on-street parking.

Reference

- Sec. 2.1 Ground and Floor Surfaces
- Sec. 3.3 Exterior Paths of Travel
- Sec. 3.4 Curb Ramps and Depressed Curbs
- Sec. 5.7 Lighting
- Sec. 5.8 Signage and Wayfinding

Exception

Off-street parking facilities that are used exclusively to park the following types of vehicles:

- buses;
- delivery vehicles;
- law enforcement vehicles;
- medical transportation vehicles, such as ambulances; and
- impounded vehicles.

The requirements in respect of off-street parking facilities do not apply to off-street parking facilities if:

- the off-street parking facilities are not located on a barrier-free path of travel, regulated under Ontario's Building Code;
- the facility is one of multiple off-street parking facilities on a single site that serve a building or facility, where appropriate accessible parking facilities are provided elsewhere on the same site.

Best Practice

Four percent (4%) of the total number of parking spaces to be accessible.

Where facilities may expect a higher proportion of people with disabilities using their services (e.g., Seniors' Centres, Long Term Care and other medical facilities), the provision of additional accessible parking spaces is to be determined on a case by case basis. The appropriate number of spaces may be calculated based on the anticipated demand and a detailed review of the facility's occupancy levels.

Note

The values in Table 3 are derived from formulas contained in the Regulation. The Regulation uses percentages to determine the number of spaces that are to be accessible and ratios to divide them between Type A or Type B.

Where an uneven number of accessible parking spaces are required, the extra Type B space may be changed to a Type A space.

3.1.1 Types of Parking

Two (2) types of accessible parking spaces are required where parking is provided:

- a. **Type A** spaces (minimum 3400 mm wide) consist of wider parking spaces which accommodate larger vehicles such as vans that are equipped with transfer ramps for users of wheeled mobility aids; and
- b. **Type B** spaces (minimum 2400 mm wide) are standard parking spaces which accommodate users who are ambulatory but have limited mobility and cannot travel lengthy distances, or use other mobility aids, such as canes, crutches and walkers.

3.1.2 Provision

- a. provide Type A and Type B spaces in accordance with **Table 3**:

Table 3: Accessible Parking Provision Requirements

Total Number of Parking Spaces	Total Number of Accessible Spaces Required	Number of Type A	Number of Type B
1 - 12	1	1	0
13 - 25	1	0	1
26 - 50	2	1	1
51 - 75	3	1	2
76 - 100	4	2	2
101 - 133	5	2	3
134 - 166	6	3	3
167 - 250	7	3	4
251 - 300	8	4	4
301 - 350	9	4	5
351 - 400	10	5	5
401 - 450	11	5	6
451 - 500	12	6	6
501 - 550	13	6	7
551 - 600	14	7	7
601 - 650	15	7	8
651 - 700	16	8	8
701 - 750	17	8	9
751 - 800	18	9	9
801 - 850	19	9	10
851 - 900	20	10	10
901 - 950	21	10	11
951 - 1000	22	11	11
1001 and over	11 +1 % of total	(1) Where an even number is required, provide equal number of Type A and B (2) Where an odd number is required, provide equal number of Type A and B plus an additional Type B.	

- b. where a parking facility serves multiple buildings or accessible entrances, distribute accessible parking spaces to enable users to park near as many accessible entrances as possible;
- c. where more than one parking facility is provided at a site:
 - i. ensure the number and type of accessible parking spaces provided is determined based on the total number of parking spaces required for each of the separate parking facilities; and
 - ii. locate and distribute accessible parking spaces among the off-street parking facilities in a manner that provides substantially equivalent or greater accessibility in terms of distance from an accessible entrance or user convenience (e.g., protection from weather, lighting, security and comparative maintenance).
- d. where the parking facility is a multi-level parking facility, ensure the accessible parking spaces are easy to identify and have at least one accessible route leading to an entrance, exit or elevator lobby.

Best Practice

Ensure accessible parking spaces are located within 30 metres (maximum) from accessible entrance(s).

Accessible parking spaces and adjacent access aisles should be regularly maintained, kept clear of debris and snow, and where possible, have overhead protection for users from the elements (e.g., such as direct sun, rain or snow).

Avoid having the accessible route cross through a drive aisle. Pedestrians should not have to travel behind parked vehicles or move along roadways. Ensure any pedestrian crossing or travel area is clearly marked so it is visible to drivers and pedestrians.

Where spaces are configured such that the front or rear of parked vehicles is immediately adjacent to a pedestrian walkway, consider a design that prevents vehicle overhangs which could reduce the width of the walkway.

Provide additional vertical height clearance of 2750 mm (min.) to accommodate larger vehicles.

3.1.3 Design and Layout

- a. locate accessible parking spaces as close as possible to an accessible entrance and integrate with an accessible route;
- b. ensure ground surface is firm, stable and slip-resistant;
- c. maximum running slope of surface at 1:50 (2%);
- d. maximum cross-slope of surface at 1:50 (2%);
- e. length of 5200 mm (**Figure 25**);
- f. minimum width of 3400 mm for “Type A” wide van accessible spaces and minimum width of 2400 mm for “Type B” standard parking spaces (**Figure 25**);
- g. provide an access aisle adjacent and parallel to each accessible parking space (**Figure 25**):
 - i. 1500 mm wide (minimum);
 - ii. extend the full length of the space;
 - iii. clearly indicated by high colour contrast diagonal pavement markings;
 - iv. where two accessible parking spaces are provided adjacent to each other, they may share an access aisle;
 - v. connect with adjacent accessible path of travel and centre curb ramp on access aisle;
- h. ensure vertical height clearance of 2100 mm (minimum) at designated parking spaces and along the vehicle access and egress routes; and
- i. provide lighting in accordance with Section 5.7 Lighting requirements, as applicable.

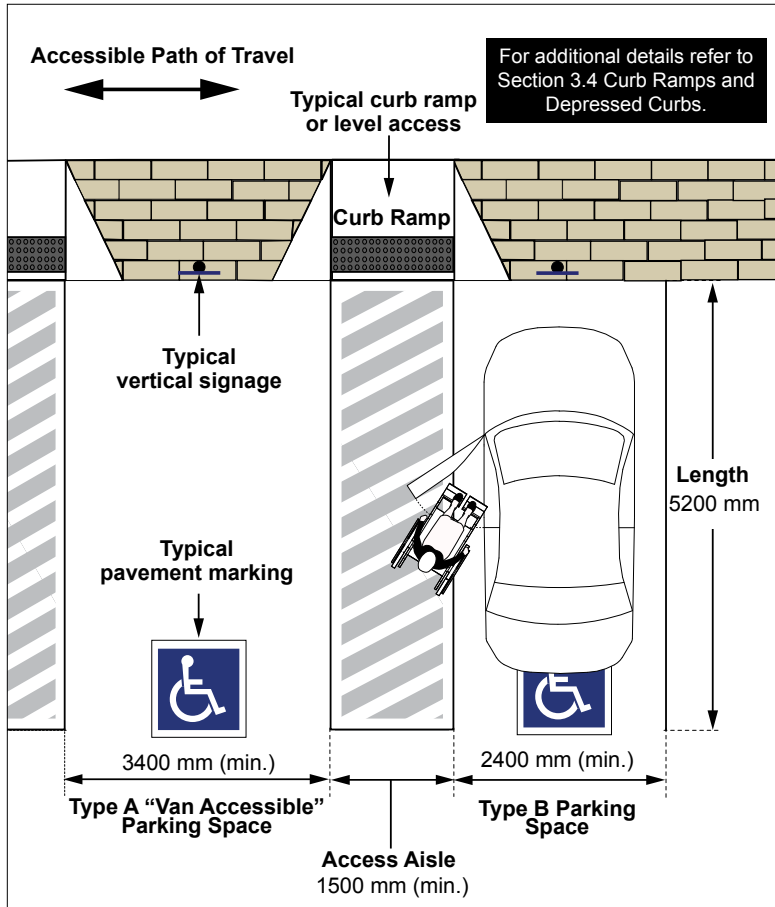

Figure 25: Accessible Parking Space Dimensions - Plan View



Accessible parking spaces with shared access aisle.
Source: Taken from "Illustrated Technical Guide to the Accessibility Standard for the Design of Public Spaces" by GAATES, 2014, p. 123.



Accessible parking spaces with access aisle and curb ramp.
Source: Taken from "Illustrated Technical Guide to the Accessibility Standard for the Design of Public Spaces" by GAATES, 2014, p. 115.

3.1.4 Signage and Pavement Markings

- ensure spaces are clearly designated with pavement markings and vertical signage, containing the International Symbol of Accessibility (**Figure 26 & 27**); and
- provide directional signage, marked with the International Symbol of Accessibility, to indicate the location of accessible parking spaces, and / or the location of the nearest accessible entrance if the spaces or entrance are not easy for users to locate when entering or using the site.

3.1.4.1 Vertical Signage

- mark with International Symbol of Accessibility;
- ensure size of 300 mm wide by 600 mm high (minimum);
- mount at height of 1500 mm to 2000 mm (centre) (e.g., wall or post-mounted), from ground / floor;
- ensure a high tonal contrast is provided between sign and background environment;
- provide information text, compliant with City By-law requirements; and
- provide additional bilingual signage that identifies Type A spaces as "van accessible / fourgonnette accessible".

3.1.4.2 Pavement Marking

- a. mark with International Symbol of Accessibility;
 - i. ensure 1525 mm wide by 1525 mm depth (minimum);
 - ii. provide a white or yellow border with a blue background field colour;
 - iii. locate near the back of the space for 90 degree or angled parking spaces and centered for parallel parking spaces; and
- b. ensure all pavement markings are slip resistant and clearly visible through use of high tonal contrast compared to the surface of the parking space.

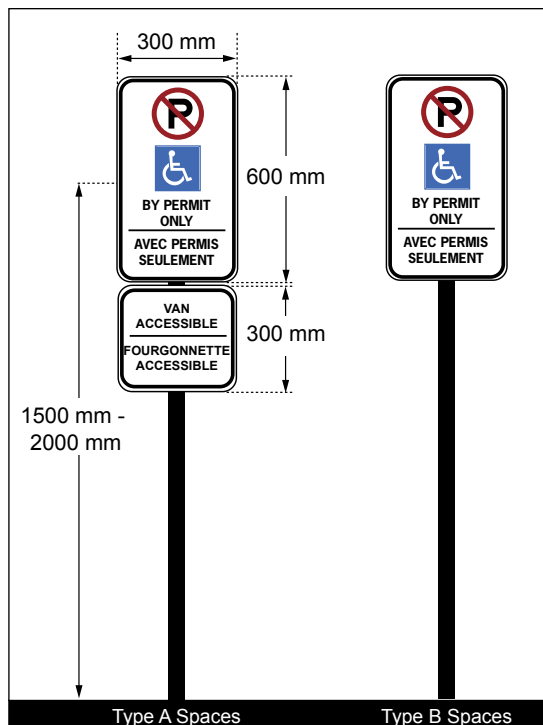

Figure 26: Accessible Parking Vertical Signage

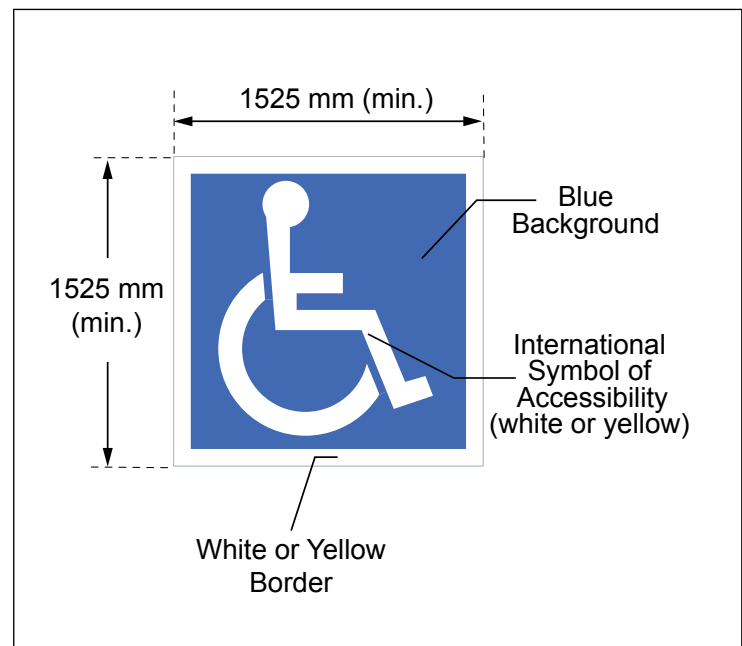

Figure 27: Accessible Parking Pavement Marking

3.1.5 On-Street Parking

When constructing new or redeveloping existing on-street parking spaces, consultation on the need, location and design of accessible on-street parking spaces must occur with:

- a. the public and persons with disabilities; and
- b. the City of Ottawa Accessibility Advisory Committee.

3.1.6 Additional Considerations - On-Street Parking

The City of Ottawa provides special parking privileges in public parking areas and on public roadways to holders of a valid Accessible Parking Permit. Any person who holds an Accessible Parking Permit (APP) is eligible. Detailed information on the City's APP program, including on-street privileges, off-street privileges, and restrictions of the program can be found on the City of Ottawa website.



Passenger Loading Zones

3.2

Application

This section applies to exterior passenger loading and drop-off zones where passengers transfer from vehicles to a pedestrian area which provides an accessible route to a facility.

Passenger loading and drop-off zones are important features for:

- people who have difficulty walking long distances or have limited stamina;
- users of mobility aids; and
- people who travel with companions or caregivers (e.g., person with vision loss or cognitive disability, the very young, and seniors).

Reference

- Sec. 2.7 Tactile Walking Surface Indicators
- Sec. 3.3 Exterior Paths of Travel
- Sec. 3.4 Curb Ramps and Depressed Curbs
- Sec. 5.7 Lighting
- Sec. 5.8 Signage and Wayfinding

Note

Transit stops, shelters and related amenities are not classified as part of passenger loading zones.

Refer to Section 6.20 Public Transit for more details.

3.2.1 Design and Layout

- a. locate the Passenger Loading Zone (PLZ) as close as possible to the nearest accessible entrance or within 30 metres (maximum);
- b. locate the PLZ away from any traffic flow and design so that users avoid entering any adjacent vehicular routes and drive aisles;
- c. where practical, provide overhead protection (e.g., a canopy to protect users from weather conditions) with clearance (i.e., vertical dimension) of 3600 mm (minimum) throughout vehicular pull-up space and passenger loading zone;
- d. include a side access aisle that (**Figure 28**):
 - i. is adjacent, parallel and at the same level as the vehicular pull-up space;
 - ii. is 2440 mm wide by 7400 mm long (minimum);
 - iii. provides a clearance height of 3600 mm (minimum) at the vehicle pull-up space and along the vehicle access and egress routes; and
 - iv. provides diagonal pavement markings (e.g., yellow or white colour and are clearly visible through use of high tonal contrast compared to surface), extending the full length of the space;
- e. provide at least one curb ramp, for users of mobility aids, where there is a change in level; and
- f. where the accessible route and the access aisle are not separated by a curb, consider installing tactile walking surface indicators (TWSIs) or other warning features (e.g., bollards). If using TWSIs, ensure that they:
 - i. are detectable by foot or cane;
 - ii. are clearly visible through the use of high tonal contrast compared to adjacent mounting surface; and
 - iii. extend across the full length of the space.

3.2.2 Vertical Signage

- a. mark with the International Symbol of Accessibility to formally designate passenger loading and drop-off zones;
- b. ensure size of 300 mm wide by 600 mm high (minimum) (**Figure 29**);
- c. mount at height of 1500 mm to 2000 mm (centre) (e.g., wall or post-mounted), from ground / floor; and
- d. provide information text, compliant with City By-law requirements (e.g., “Accessible Loading Zone / Zone D’Embarquement Accessible”).

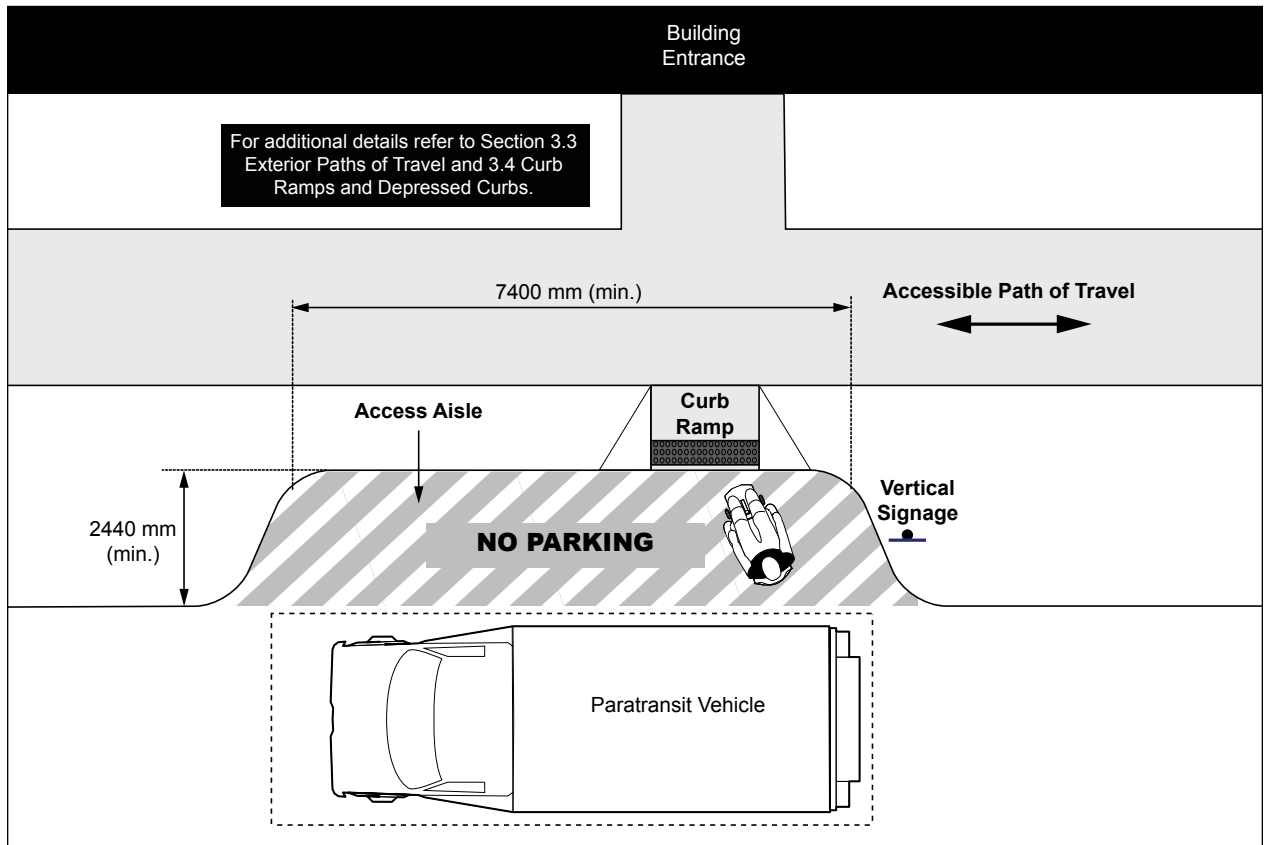

Figure 28: Passenger Loading Zone - Plan View

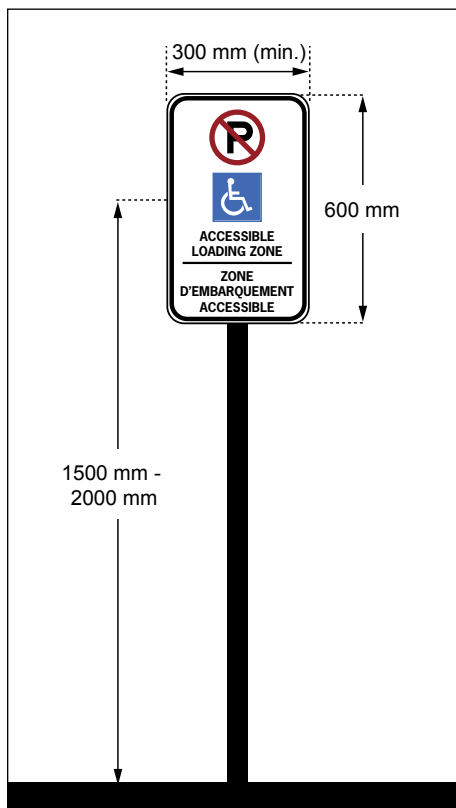

Figure 29: Accessible Loading Zone Vertical Signage



Exterior Paths of Travel

3.3

Application

This section applies to exterior paths of travel, which typically include, but are not limited to:

- pedestrian circulation routes that serve as connections between the property line / site boundary of a facility, or at facility entrances, exits, elements or amenities;
- public right-of-ways (e.g., sidewalks and walkways);
- ramps; and
- curb ramps.

This section applies to sidewalks or walkways used for pedestrian travel and not to provide a recreational experience.

Reference

- Sec. 2.1 Ground and Floor Surfaces
- Sec. 2.2 Ramps
- Sec. 2.4 Guards and Handrails
- Sec. 2.5 Overhanging and Protruding Objects
- Sec. 2.6 Rest Areas
- Sec. 3.4 Curb Ramps and Depressed Curbs
- Sec. 5.7 Lighting
- Sec. 6.15 Recreational Trails, Beach Access Routes and Boardwalks
- Sec. 6.17 Inclusive Play Spaces

Best Practice

Where possible, provide clear width of 2000 mm (minimum) for exterior paths of travel.

Note

The contrasting surface adjacent to the accessible route may be accomplished by landscaping features such as grass or alternative textured material. Consider locating all planting and street furniture in an amenity zone, adjacent to the sidewalk or walkway, and using a different tone or material to emphasize the difference in function of the amenity zone.

It is important that the cross slope be minimal to allow for adequate drainage. The greater the cross slope, the more likely it will affect the balance of an individual while walking or using a mobility aid.

3.3.1 General Features

- ensure ground surfaces are firm, stable and slip-resistant;
- provide adequate drainage to prevent water accumulation;
- ensure headroom clearance is not less than 2100 mm;
- provide lighting in accordance with Section 5.7 Lighting requirements, as applicable;
- provide a high tonal or textural contrast on ground surfaces to help define primary accessible routes and assist with wayfinding;
- where a pedestrian route crosses or joins a vehicular route and the walking surfaces are not separated by curbs, railings or other elements between the pedestrian and vehicular areas, provide tactile walking surface indicators (TWSI), continuous along the full length of the crossing boundary; and
- consider providing level rest areas and stopping places along the path of travel, especially sloped walkways longer than 30 metres, for users of mobility aids and people with reduced stamina (**Figure 30c**).

3.3.2 Clear Width

- provide clear width of 1800 mm (minimum) (**Figure 30a**);
- where the clear width of exterior paths of travel is less than 1800 mm (minimum), provide a passing area, 1800 mm wide by 1800 mm long (minimum) at intervals of 30 metres or less (**Figure 30b**);
- where passing areas are provided, ensure they are not considered to be part of any rest area that may also be provided; and
- ensure the entrance to exterior paths of travel provide a clear opening of 850 mm (minimum), whether the entrance includes a gate, bollard or other entrance design.

3.3.3 Running and Cross Slopes

3.3.3.1 Running Slope

Exterior walks that form part of an accessible path of travel under the jurisdiction of Ontario's Building Code must be designed as a ramp where the gradient is greater than 1:20 (5%). Curb ramps are excepted from this requirement.

- maximum running slope is 1:20 (5%) (**Figure 31a**); and
- where the exterior path of travel is a sidewalk, a running slope greater than 1:20 (5%) is allowed but it cannot be steeper than the slope of the adjacent roadway.

3.3.3.2 Cross Slope

- a. provide a maximum cross slope of:
 - i. 1:20 (5%), where the surface is asphalt, concrete or some other hard surface (**Figure 31b**); or
 - ii. 1:10 (10%) in all other cases.

Best Practice

Cross slope gradient of 1:50 (2%) or less is recommended.

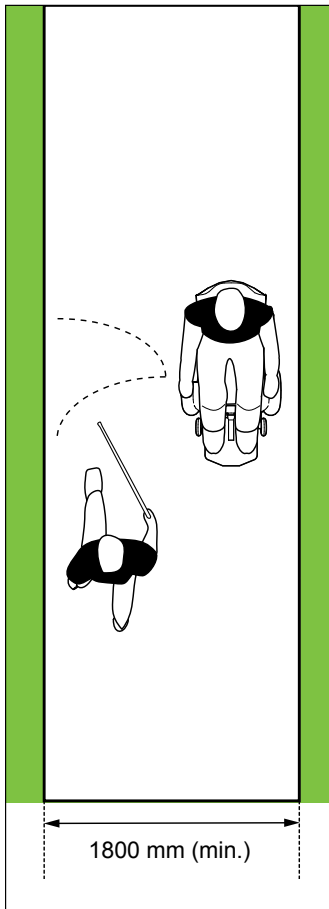

Figure 30a: Minimum Clear Width of Exterior Path of Travel

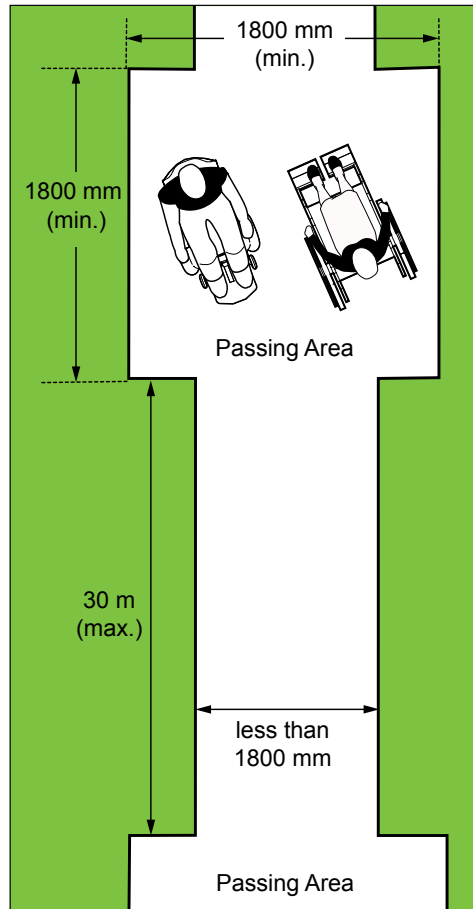

Figure 30b: Reduced Clear Width and Required Passing Area

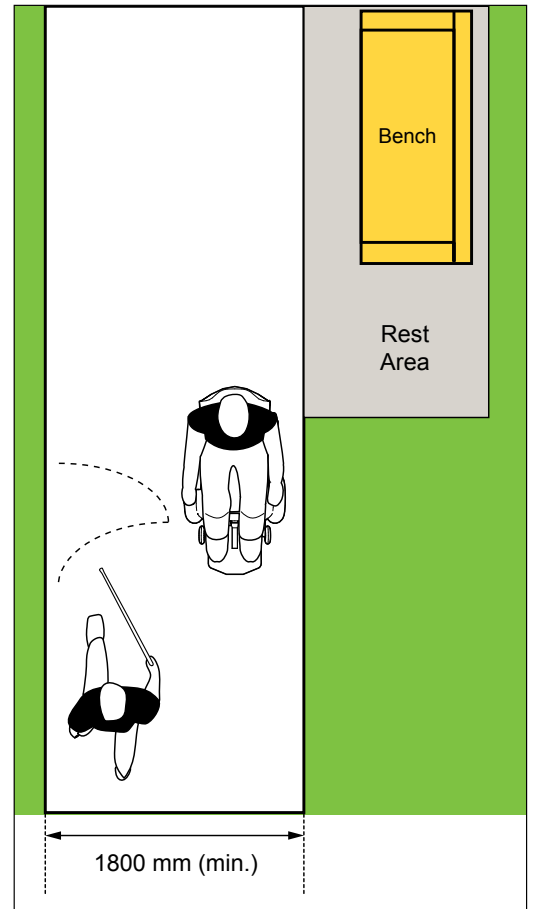

Figure 30c: Rest Area

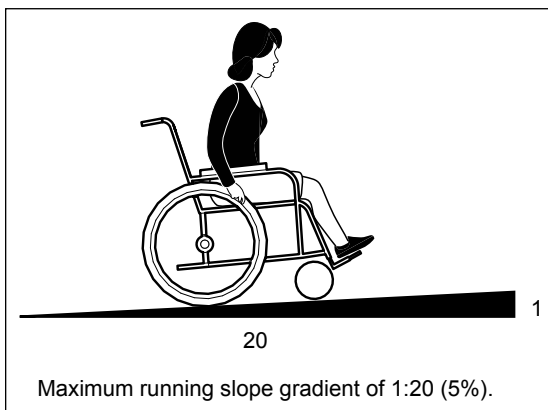

Figure 31a: Running Slope

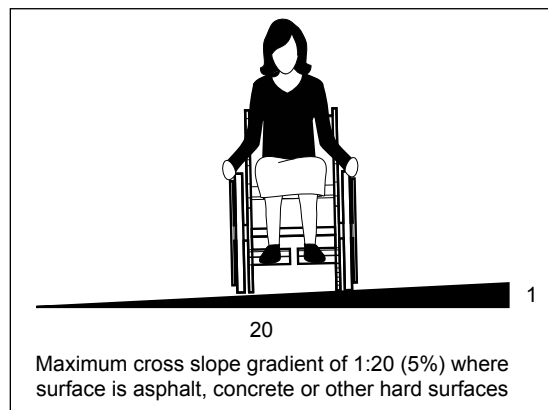

Figure 31b: Cross-Slope

Note

Ensure curb or other barrier protection is designed to allow surface drainage.

3.3.4 Changes in Level

- a. where there is a change in level along the exterior path of travel, ensure slope requirements are provided in accordance to **Table 4**:

Table 4: Change in Level - Slope Requirements

Change in Level (height)	Slope Requirements
1 - 5 mm	No bevel required
6 - 13 mm	1:2 bevel
14 - 74 mm	maximum running slope 1:8 (12.5%) or provide a curb ramp
75 - 200 mm	maximum running slope 1:10 (10%) or provide a curb ramp
more than 200 mm	provide a ramp

Exception

Guards are not required if the slope of the surface adjacent to the accessible route is not steeper than 1:2 within 1200 mm from the accessible route (**Figure 32b**).

- b. where there is a change in level or drop-off immediately adjacent to the accessible path of travel,
- provide colour contrasted curb or other barrier protection, 75 mm (minimum) high above path of travel, where change in level is between 200 and 600 mm (**Figure 32a**); and
 - provide guards mounted at 1070 mm (minimum), measured vertically to the top of the guard from the ground surface, where change in level is more than 600 mm or where the adjacent surface within 1200 mm from the accessible route has a slope of more than 1:2 (**Figure 32c**).

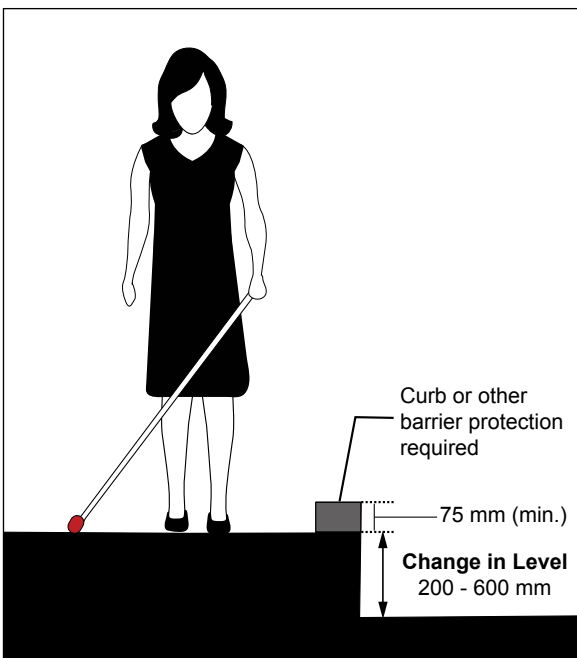

Figure 32a: Edge Protection - Change in level between 200 mm and 600 mm adjacent to the accessible path of travel

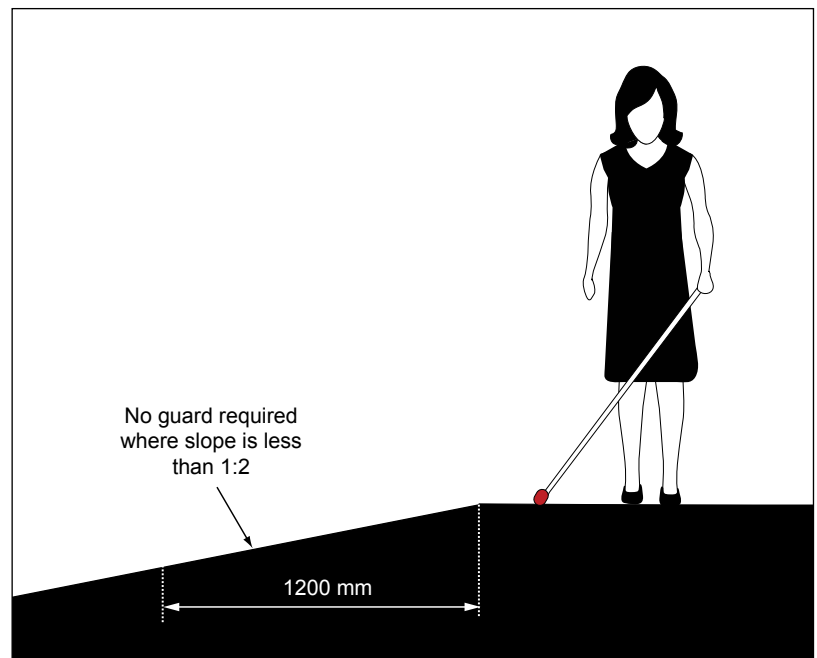

Figure 32b: No Guard Required - Surface adjacent to the accessible path of travel is not steeper than 1:2 within 1200 mm from the accessible path of travel (Exception)

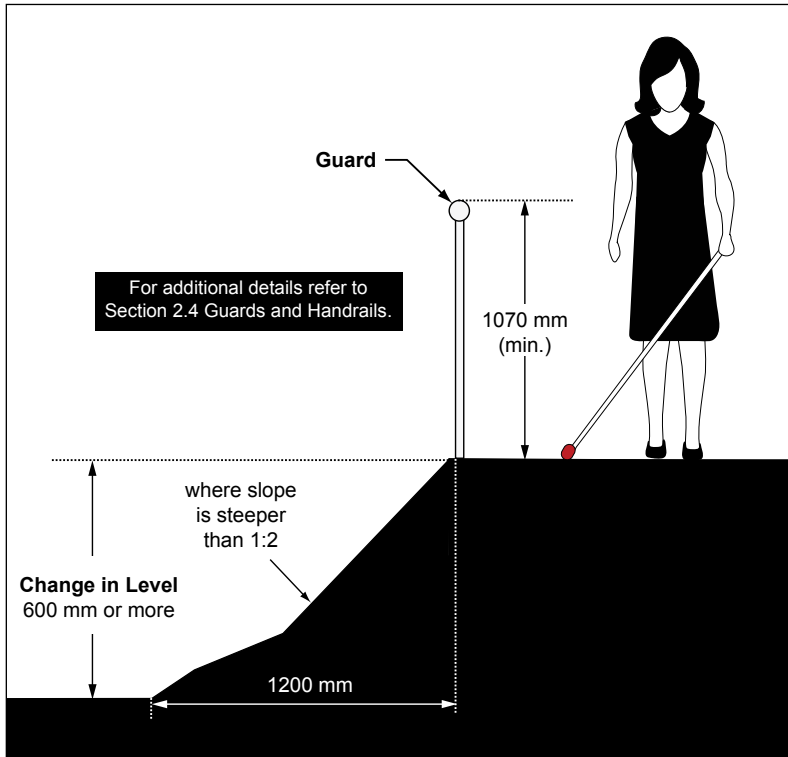

Figure 32c: Guard - Change in level more than 600 mm or where the slope of the adjacent surface within 1200 mm from the accessible path of travel is greater than 1:2

3.3.5 Rest Areas

When constructing new or redeveloping existing exterior paths of travel intended to be maintained, Section 2.6 “Rest Areas” applies.



3.4

Application

Curb ramps and depressed curbs help people with disabilities safely and independently negotiate level changes on public sidewalks and other pedestrian routes. They are required when there is a change in level between exterior path of travel and adjacent vehicular route.

The provision of curb ramps and depressed curbs ensures a continuous accessible path of travel between vehicular and pedestrian routes, for the following typical locations:

- pedestrian crossings at intersections;
- parking spaces, passenger loading zones and related access aisles; and
- any other exterior pedestrian route where there are elevation changes.

The choice between providing a curb ramp or a depressed curb depends on physical characteristics, volume of pedestrian traffic and space availability. The flared sides of the curb ramps provide additional directional assistance, however, having a raised curb between curb ramps may not be suitable to high pedestrian traffic locations, or possible due to intersection geometry, and therefore a depressed curb may be chosen.

Corners where the depressed curb continues from one crosswalk, around the corner radius, and through the next crosswalk are also called “depressed corners”.

Reference

- Sec. 2.1 Ground and Floor Surfaces
- Sec. 2.7 Tactile Walking Surface Indicators
- Sec. 3.1 Parking
- Sec. 3.2 Passenger Loading Zones
- Sec. 3.3 Exterior Paths of Travel

Note

“Curb ramp” means a ramp that is cut through a curb at a roadway and slopes up to a sidewalk. Types are usually categorized by their structural design and how they are positioned relative to the sidewalk and roadway. Permitted curb ramp types include:

- perpendicular - one that is aligned so that the ramp is generally perpendicular to the centreline of the roadway, and users will generally be travelling perpendicular to traffic when they enter the street at the bottom;
- parallel - one that has two ramps leading towards a centre level landing at the bottom; and
- combination of perpendicular and parallel.

“Depressed curb” means a seamless gradual slope at transitions between sidewalks and walkways and highways, and is usually found at intersections.

3.4.1 Design and Layout

- ensure surface is stable, firm and slip-resistant;
- ensure curb ramp or depressed curb is aligned with the direction of travel (e.g., crosswalks) and curb ramp or depressed curb on the opposite side of the roadway to help users orient themselves and to allow someone to maintain a straight line of travel;
- design to provide suitable drainage, to prevent water, snow and ice accumulation within the accessible path of travel; and
- ensure gratings and other openings are not placed on curb ramps, depressed curb or within pedestrian crossings.

3.4.2 Width

- provide clear width of 1500 mm (minimum), exclusive of flared sides (**Figure 33b**);
- where the width of the sidewalk is greater than 1500 mm, provide curb ramp with the same width as the sidewalk, exclusive of flared sides; and
- for depressed corners, the length of the depressed curb is dependent on the width of the sidewalks and the corner radius, but should be no less than 3300 mm.

3.4.3 Running and Cross Slopes

- ensure maximum running slope of 8.33% (1:12) for curb ramps;
- for retrofit applications, ensure maximum running slope of 10% (1:10) for curb ramps;
- for depressed curbs / corners, ensure maximum running slope of 1:20 (5%);
- ensure maximum cross slope of 1:50 (2%); and
- where the counter slope at a curb ramp or depressed curb is greater than 11%, provide a transition area that:
 - extends the full width of the curb ramp;
 - begins at the base of the curb ramp and extends to a length of at least 600 mm on the street (**Figure 34**); and
 - has a maximum cross slope gradient of 1:50 (2%) maximum.

3.4.4 Flared Sides

Where curb ramps are provided, they shall have flared sides:

- ensure surface is stable, firm, slip-resistant and non-glare;
- ensure the sides are clearly demarcated with grooved edges; and
- provide a slope gradient between 6.7% and 10% (1:15 and 1:10), measured parallel to the curb line (**Figure 33b**).

Best Practice

Provide a maximum running slope of 5% and cross slope of zero.

Provide a counter slope less than 11%.

Provide a landing of 1650 by 1650 mm or more where possible to accommodate larger wheeled mobility aids.

Note

It can be very difficult for people with visual disabilities to orient themselves relative to the crosswalks at very large depressed corners. Instead of a fully depressed corner, consider providing a full height curb around the corner radius with appropriate transitions from the separate depressed curbs or curb ramps at each crosswalk.

Landings shall be permitted to overlap other landings and clear space.

Flared sides are not considered part of the accessible path of travel.

For a typical 150 mm high barrier curb, the tapered curb section will be 1500 mm for 10% slope and 2200 mm for 6.7% slope.

Note

Concrete border width around TWSI may be increased and adjusted to suit corner geometry.

3.4.5 Landing

- a. ensure a level landing 1200 mm by 1200 mm (minimum) is provided at the top of the curb ramp (**Figure 33b**);
- b. provide an additional landing if users must change direction while using the curb ramp;
- c. ensure running and cross slopes are 2% (1:50) (maximum); and
- d. landings are not required at depressed curbs since the associated shallow slope will suffice.

3.4.6 Tactile Walking Surface Indicator (TWSI)

Where curb ramps or depressed curbs are provided on an exterior path of travel, provide tactile walking surface indicators in accordance with Section 2.7 “Tactile Walking Surface Indicators” and also the following:

- a. are installed at the bottom portion of the curb ramp or depressed curb, set back 150 to 200 mm from the back edge of the curb, and following any curvature in the curb;
- b. are installed in concrete and with a minimum 150 mm concrete border around the TWSI for locations within a non-concrete sidewalk or walkway;
- c. are installed with the tops of the domes level with the adjacent concrete surface;
- d. have drainage cuts from the lower corners and other low points of the TWSI to the curb;
- e. have a minimum depth of 610 mm (**Figure 33b**);
- f. for curb ramps, ensure TWSI extend along the full width of the curb ramp (**Figure 33b**);
- g. for depressed curbs, ensure TWSI extend along the bottom portion of the depressed curb that is flush with the roadway, and to a minimum width of 1500 mm; and
- h. for depressed corners where two pedestrian crossings are provided, ensure the TWSI extend around the corner wherever the bottom portion of the curb is flush with the roadway, providing a 300 mm space (gap) in the TWSI located at the junction where the two crossings meet (**Figure 35**).

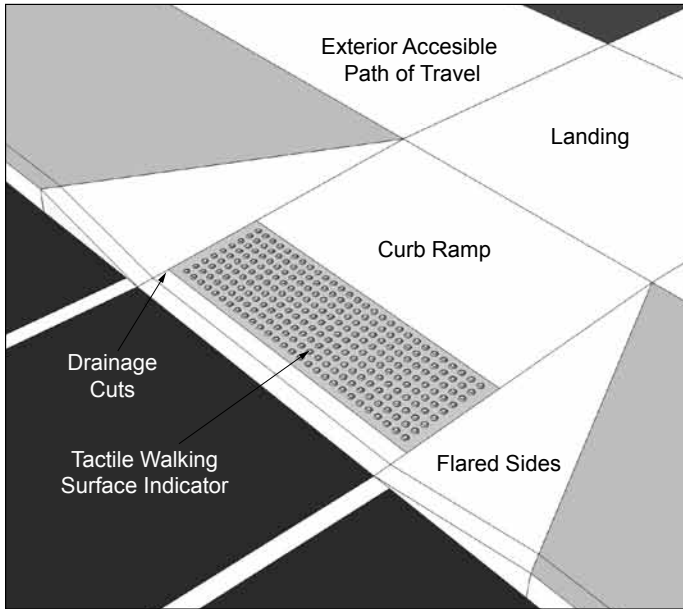

Figure 33a: Typical Curb Ramp

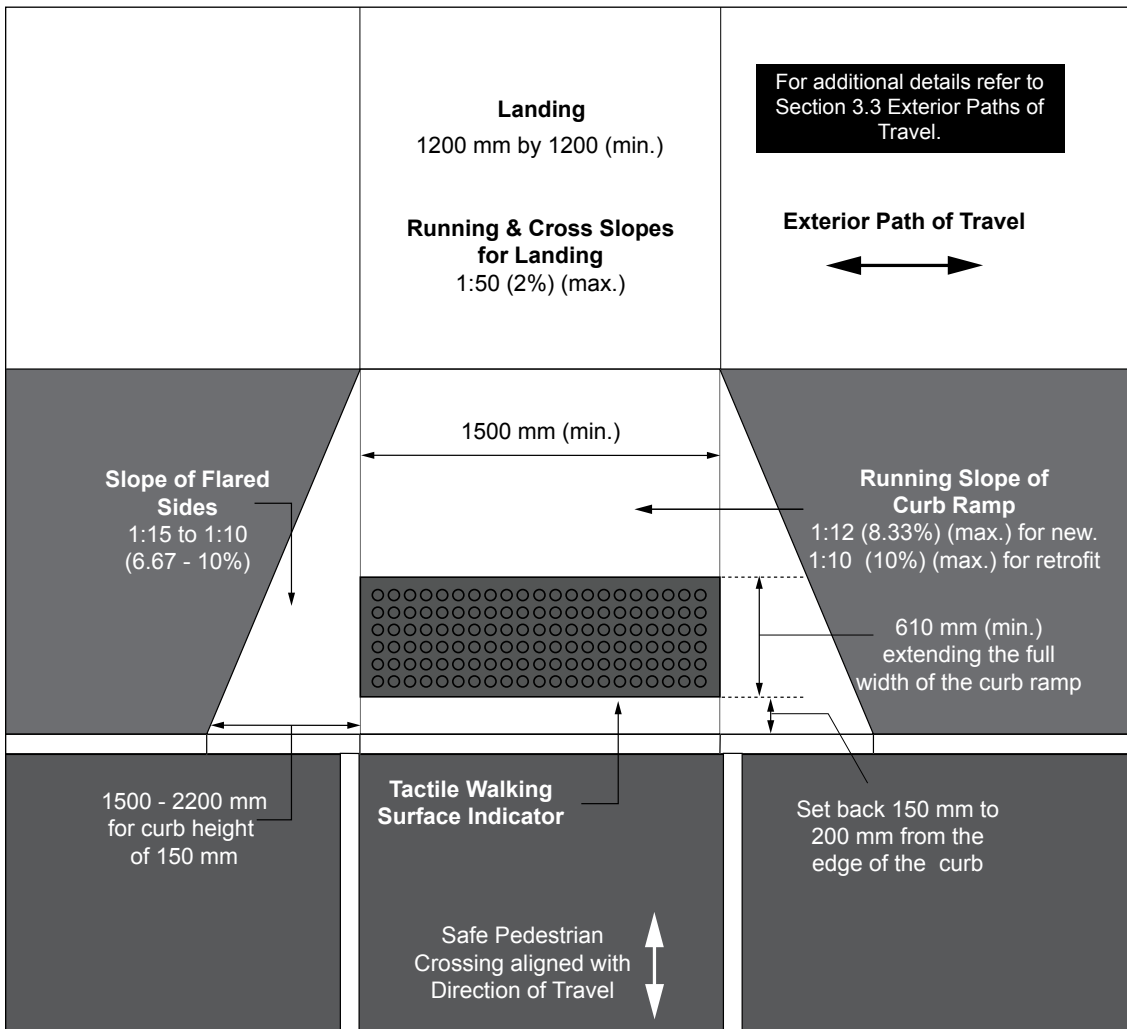

Figure 33b: Typical Curb Ramp Design - Plan View

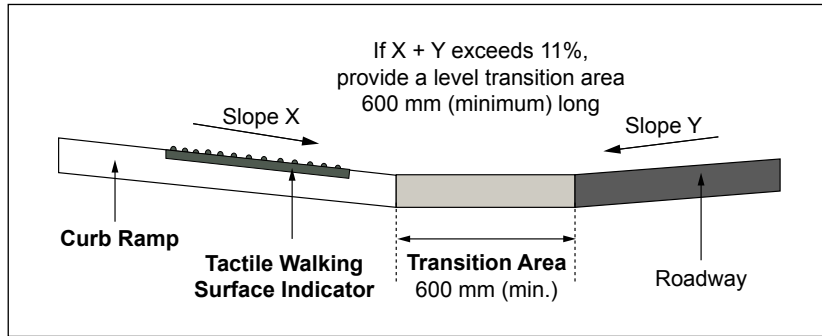

Figure 34: Transition Area - Counter Slope

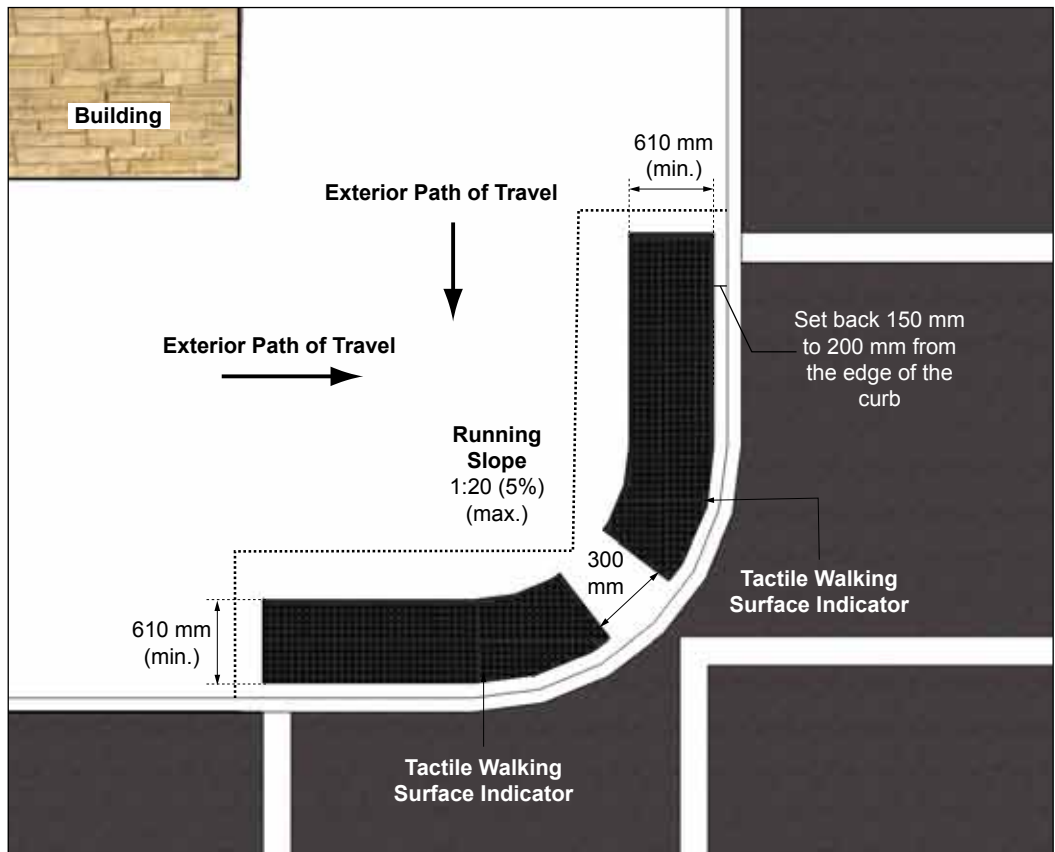

Figure 35: Typical Depressed Corner Design - Plan View



Application

This section addresses accessible pedestrian signals (APS) where provided at exterior paths of travel as per the Accessibility for Ontarians with Disabilities Act's Integrated Accessibility Standards Regulation : Design of Public Spaces Standard Clause 80.28.

Note

Detailed information is provided in "Appendix A" of the Transportation Association of Canada's "Guidelines for Understanding, Use and Implementation of Accessible Pedestrian Signals" - August 2008 (or current version).

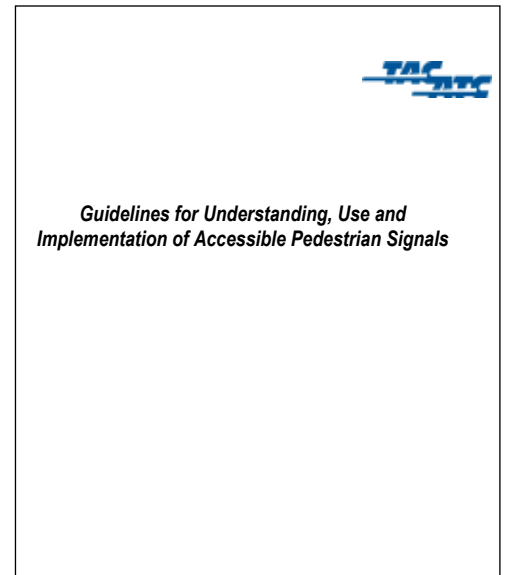

Note

The term “pedestrian crossover” is defined in the Highway Traffic Act as: “any portion of a roadway, designated by by-law of a municipality at an intersection or elsewhere, distinctly indicated for pedestrian crossing by signs on the highway and lines or other markings on the surface of the roadway as prescribed by the regulations.”

3.5.1 Provision

Accessible Pedestrian Signals (APS) must be provided where new pedestrian signals are being installed or existing pedestrian signals are being replaced at a pedestrian crossover.

3.5.2 Design & Layout

Accessible pedestrian signals to meet the following requirements:

- a. provide a locator tone that is distinct from a walk indicator tone;
- b. install within 1500 mm of the edge of the curb;
- c. mount at 1100 mm (maximum) high above ground level;
- d. provide tactile arrows that align with the direction of crossing;
- e. include both manual and automatic activation features;
- f. include both audible and vibro-tactile walk indicators;
- g. where two APS assemblies are installed on the same corner, ensure they are installed a minimum of 3000 mm apart; and
- h. where two APS assemblies cannot be installed 3000 mm (minimum) apart because of site constraints or existing infrastructure, they can be installed on a single post and must include a verbal announcement clearly stating which crossing is active.



Typical APS actuation.

Interior Environments

4.0

Table of Contents

4.1	Entrances	83
4.2	Doors and Doorways	85
4.3	Interior Accessible Routes	96
4.4	Elevating Devices	100
4.5	Washrooms.....	103
4.6	Showers	118

[Page intentionally left blank for printing purposes.]



Entrances

4.1

Application

This section applies to pedestrian entrances into facilities. Entrances include all access and entry points into a facility. An entrance typically consists of several elements and includes the approach and route leading to a facility, the components of the entrance itself and transition area between exterior and interior environments (e.g., vestibule). It may also include an interior lobby or waiting area, where applicable.

Reference

- Sec. 2.2 Ramps
- Sec. 2.3 Stairs
- Sec. 2.4 Guards and Handrails
- Sec. 2.6 Rest Areas
- Sec. 2.7 Tactile Walking Surface Indicators
- Sec. 2.10 Seating, Tables and Work Surfaces
- Sec. 4.2 Doors and Doorways
- Sec. 5.7 Lighting
- Sec. 5.8 Signage and Wayfinding
- Sec. 6.10 Service Counters
- Sec. 6.11 Waiting and Queuing Areas

Note

Where several doors are provided adjacent to each other (e.g., a bank of doors), these doors are considered a single entrance.

Best Practice

Consider providing automatic sliding doors at highly used entrances.

Where an entrance is not accessible, provide directional and informational signage to identify location of the closest accessible entrance.

Note

Provide accessible features as required for building entrances from parking garages, including related elevator lobbies.

Ensure power door operators are provided on both doors, where a vestibule is provided.

4.1.1 Provision

- at least one main or primary entrance into a facility is required to be accessible (e.g., via level, sloped or ramped accessible routes);
- at least 50% of the total number of building entrances are required to be accessible, rounding up to the nearest whole number; and
- locate entrance 30 metres or less from designated accessible parking or passenger loading or drop-off zones.

4.1.2 Main or Primary Entrance Features

Where an entrance is designated as a main or primary accessible entrance into a facility:

- locate as part of an accessible path of travel, including exterior level landing area of 1670 mm by 1670 mm (minimum);
- provide power door operator and mark door with International Symbol of Accessibility (**Figure 36**);
- provide directional signage at strategic points to guide users from accessible parking areas, drop-off and loading zones, and site access points to the accessible entrance;
- ensure clear door width of 860 mm (minimum);
- where an entrance vestibule is provided, ensure:
 - the distance between the two doors in series is 1500 mm (minimum), plus the width of the door swinging into the space; or
 - a turning space of 1500 mm (minimum) diameter is provided where doors do not align; and
- where overhead protection (e.g., canopy) at pedestrian entrance and passenger loading or drop-off zones adjacent to the entrance is provided, ensure the height clearance is 2750 mm (minimum) or 3600 mm (preferred).

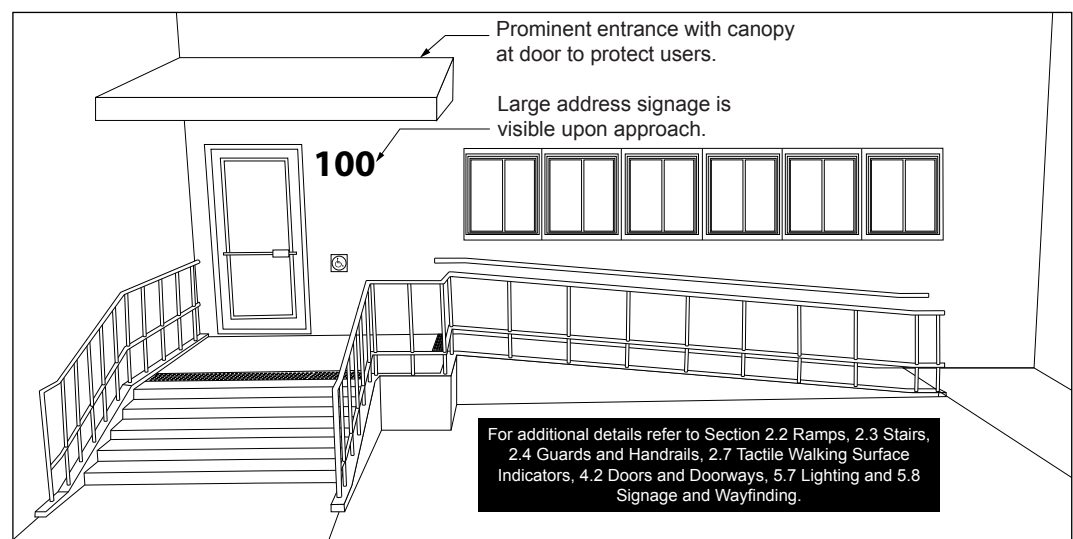

Figure 36: Main or Primary Entrance Features



Doors and Doorways

4.2

Application

This section applies to all interior and exterior doors along an accessible route, intended for staff and public use, which lead into, out of and through a facility. The provision of accessible doors as part of an accessible route is an important consideration for all users of a facility.

Where doors have more than one independently operated leaf (e.g., at a bank of doors), at least one of the door leaves is required to be accessible, meeting the criteria identified in this Section.

Reference

- Sec. 2.4 Guards and Handrails
- Sec. 5.1 Controls and Operating Mechanisms
- Sec. 5.8 Signage and Wayfinding

Note

Additional considerations are required to address issues related to doors used for fire and life safety (e.g., use of electromagnetic 'hold-open' devices and door closer adjustments).

Best Practice

Where permitted and where visual or acoustic privacy is not a design requirement, entrances without doors are preferred (e.g., public washrooms in large, assembly type facilities).

Provide clear width of 950 mm (minimum) at all doorways.

Note

Using off-set door hinges to provide the required clear width for some existing doors may be an option for consideration.

4.2.1 Clear Width

For interior and exterior doors and doorways along an accessible route:

- provide a clear width of 860 mm (minimum), measured when the door is open 90 degrees from the face of door (and / or exit door hardware that projects into the path of travel) and the opposite door stop (**Figure 37**); and
- where there is a projection into clear opening width, ensure it is 100 mm (maximum), no lower than 865 mm high above floor.

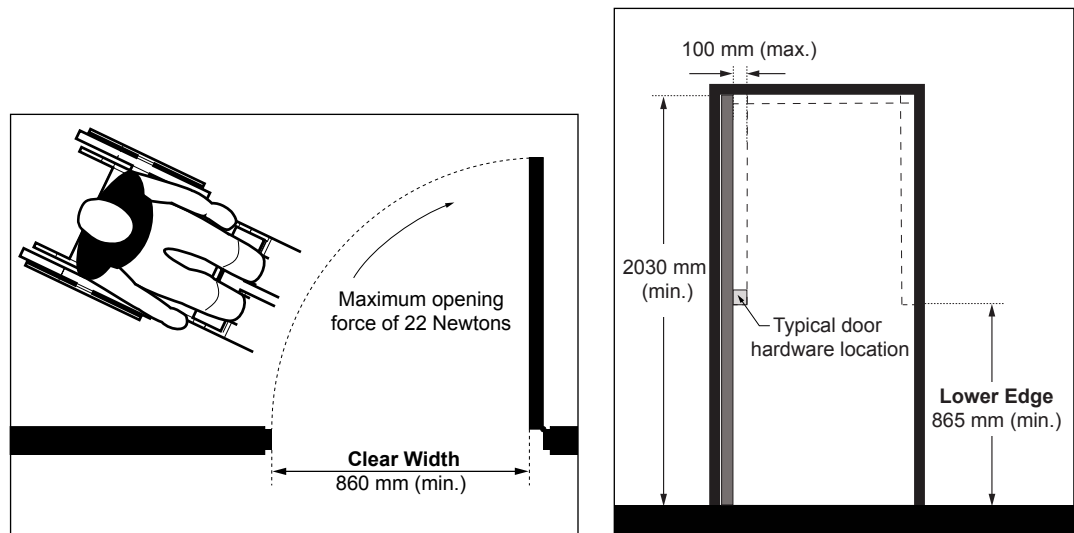

Figure 37: Clear Width of Doors - Plan and Elevation Views

4.2.2 Opening Force and Closers

4.2.2.1 Opening Force

The maximum opening force required for push / pull is:

- 38 Newtons (8.5 pounds) for exterior hinged doors;
- 22 Newtons (5 pounds) for interior hinged doors; and
- 22 Newtons (5 pounds) for sliding or folding doors.

4.2.2.2 Closers

- adjust closers so that from an open position of 90 degrees, the time required to move the door to a position of 12 degrees from the latch is 5 seconds (minimum).

Exception

Tonal contrast is not required at service doors (e.g., electrical room, maintenance room, janitor room).

4.2.3 Tonal Contrast of Doors and Frames

- provide high tonal contrast to differentiate doors and / or door frames from the surrounding environment.

Best Practice

Install door kick plates 300 mm high, measured from bottom edge of door, covering the entire width of the door, especially for high traffic areas.

Note

Knob hardware and thumb-latch handles are not appropriate because they require tight grasping and fine finger control.

Where sliding doors are provided, ensure operating hardware is usable on both sides when the door is in the open position (e.g., large D-pull handles).

Typical revolving door systems are not considered accessible entrances, recognizing the floor space within a system is limited and the speed of use is typically fast. Some specialized revolving door systems are accessible and can accommodate larger mobility aids.

4.2.4 Thresholds

- a. provide bevel at maximum slope of 1:2 (50%), where transition is between 6 mm and 13 mm high; and
- b. ensure threshold at door is not more than 13 mm high.

4.2.5 Door Hardware

Door hardware includes, but is not limited to, handles, pulls, latches and locks, with the following features:

- a. mount between 900 mm (minimum) and 1100 mm (maximum) high from finished floor or ground surface;
- b. hardware must be usable with closed fist and operable with one hand;
- c. ensure tight grasping of hands, pinching of fingers or twisting of wrists are not required to operate hardware; and
- d. ensure high tonal contrast hardware finishes are provided when compared to mounting surface.

4.2.6 Revolving Doors and Turnstiles

- a. provide accessible gate or door adjacent to turnstiles and / or revolving door, with clear width of 860 mm (minimum) (**Figure 38**); and
- b. ensure accessible gate or door is clearly marked with International Symbol of Accessibility.

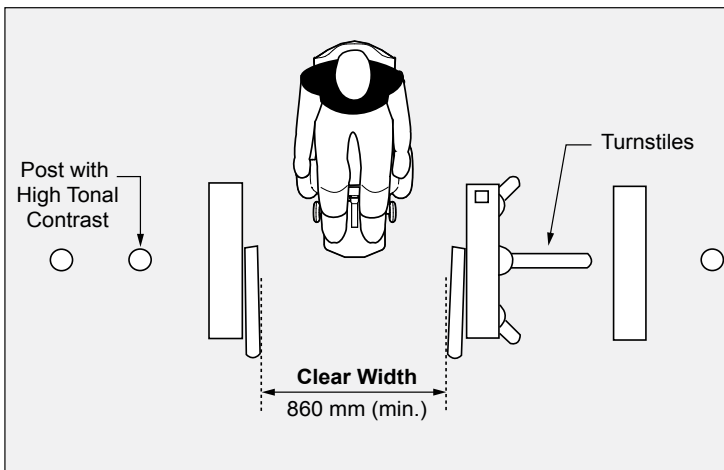

Figure 38: Accessible Controlled Gate

4.2.7 Automatic Doors

Where automatic doors are provided, which are sliding or swinging doors activated by infrared sensors:

- a. ensure sensors are suitably placed to detect users approaching; and
- b. ensure timing allows safe passage through doors.

Best Practice

For main entrances to larger facilities with high-occupancy load, an automatic sliding door system is recommended to control the flow of pedestrian traffic and facilitate access for the majority of users.

Provide power door operators for high frequency doors (e.g. large meeting / multipurpose rooms) in new construction. Consider providing roughed in power for future power door operators at other locations.

A vertical extended power door operator allows activation from any approach and height level (**Figures 39 and 40b**).

Note

Where power-assisted doors are activated by proximity card reader devices, ensure timing of door opening is synchronized with operation of proximity device.

A vertical extended power door operator control can accommodate a wider range of users (e.g., can be operated by service animals, foot or foot rest).

4.2.8 Power-Assisted Doors

Power-assisted doors have two different types of operation:

- automatically activated by a motion detector or a floor pad sensor; and
- manually activated by pushing a control.

Doors that open automatically are considered a preferred option where possible, since they do not require manual activation and address the needs of a wide range of users. This recognizes that manual power-assist controls may be difficult to locate and activate for people with limited vision, strength, manual dexterity, reach or users that may have multiple types of disabilities.

Power-assisted swing doors that are activated by pushing a control are required at the main entrance(s) and accessible washrooms of a facility.

Based on the overall design, the level of use of interior spaces and where swing doors are provided throughout a facility, power-assisted swing doors that are activated by pushing a control are also commonly provided at:

- interior doors along accessible routes and / or connecting accessible routes;
- doors into reception areas;
- doors into highly used functional spaces (e.g., larger multi-purpose rooms, meeting or board rooms); and
- doors leading to accessible exits and designated “Areas of Refuge”.



Figure 39: Example of Control for Power Door Operator Promoting Universal Use

Where power-assisted swing doors activated by pushing a control are provided:

- mark accessible doors with International Symbol of Accessibility and other signage (e.g., “Caution” decals to warn of door swing);
- ensure a force of no more than 66 Newtons is required to stop door movement;
- in case of power failure, ensure power-assisted doors can be opened manually;
- ensure door remains fully open for 5 seconds (minimum);

- e. ensure doors take 3 seconds (minimum) to move from a closed to fully open position, when activated; and
- f. provide power door operator controls on both sides of doors, for use when entering or leaving, with the following criteria:
 - i. mount in clearly visible location for easy identification upon approach on the latch side;
 - ii. ensure the dimension of the power door operator control is 150 mm (minimum) in diameter where it is circular or 150 mm wide by 915 mm long (minimum) where it is a vertical extended power door operator;
 - iii. ensure high tonal contrast is provided between power door operator control and mounting surface;
 - iv. ensure they project less than 100 mm from mounting surfaces;
 - v. mark with International Symbol of Accessibility;
 - vi. ensure controls are operable with a closed fist;
 - vii. mount at height of 900 mm to 1100 mm from ground or floor surface (**Figure 40c**);
 - viii. where rectangular extended power door operator controls are provided, mount so that they extend from not more than 200 mm and not less than 900 mm high above the floor (**Figure 40b**);
 - ix. mount between 600 mm and 1500 mm, on a level wall surface or separate post, beyond the door swing where the door opens towards the control (**Figure 40a**); and
 - x. provide a minimum clear floor space of 1675 mm by 1675 mm in front of power door operator control.

Note

Rectangular shaped power door operator control with dimensions of 50 mm by 100 mm, may only be used for retrofit situations, where standard control sizes will not fit.

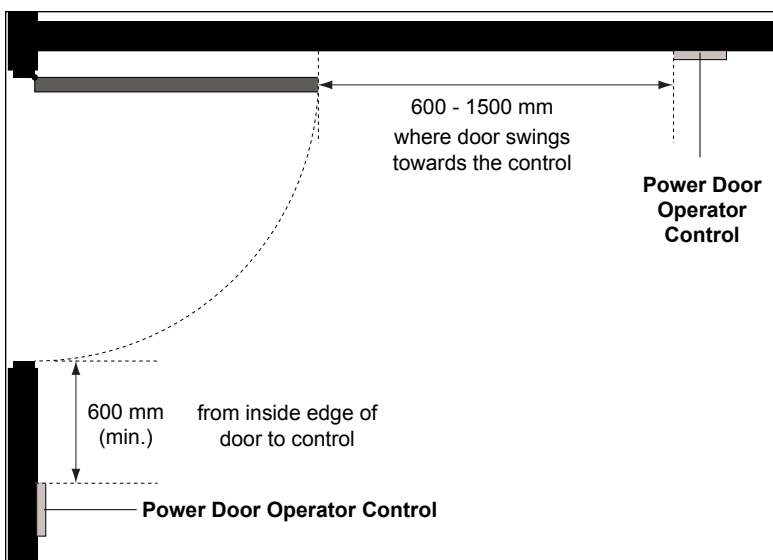

Figure 40a: Power Door Operator Control Mounting Location - Plan View



Example of rectangular shaped power door operator control to be used for retrofit situations only.

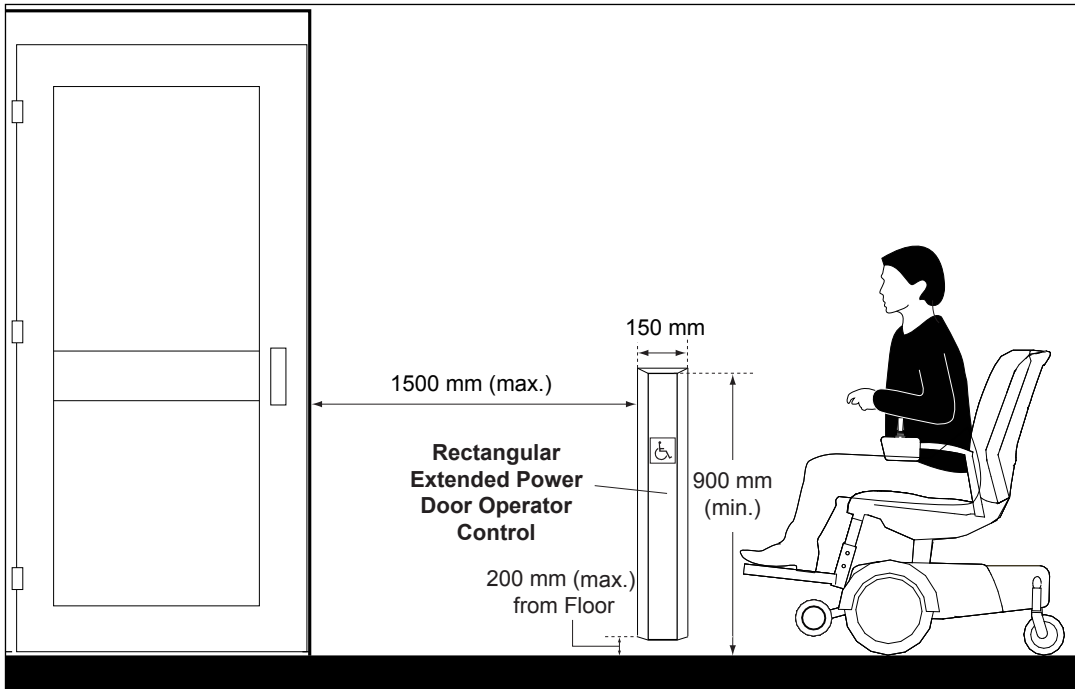

Figure 40b: Vertical Extended Power Door Operator - Elevation View



Example of large vertical extended power door operator control.

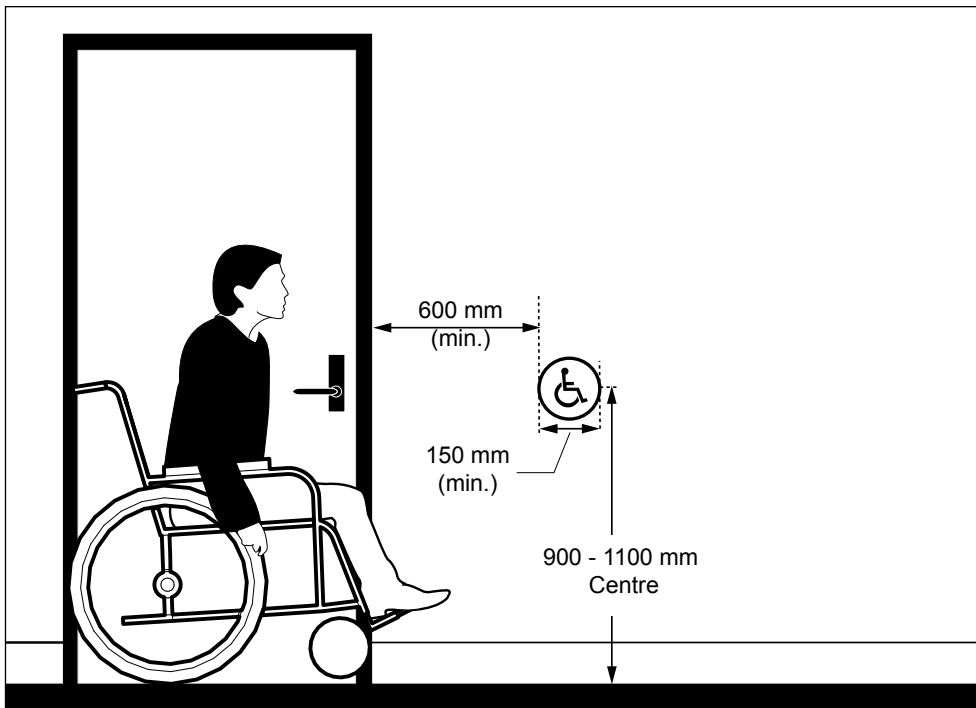

Figure 40c: Circular Power Door Operator Control - Elevation View



Example of circular power door operator control.

4.2.9 Doors swinging into Accessible Routes

Where automatic or power-assisted doors, whether activated by a control manually or automatically by a motion sensor or a floor-pad sensor that someone steps on (e.g., typically used at higher traffic doors), swing into an accessible path of travel:

- a. provision of recessed doors is preferred (**Figure 41**); or
- b. for swinging doors opening into passing pedestrian traffic, provide cane detectable guards or other devices at right angles to the wall containing the door, with the lower rail surface mounted no more than 680 mm high (maximum) from ground or floor surface, extending 300 mm (minimum) beyond the door swing, on both sides of doors (**Figure 42**).

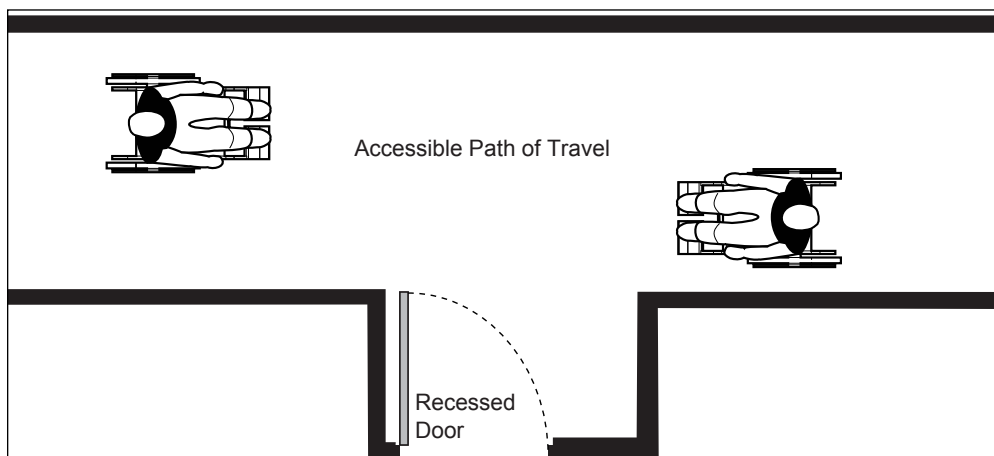

Figure 41: Recessed Door - Plan View

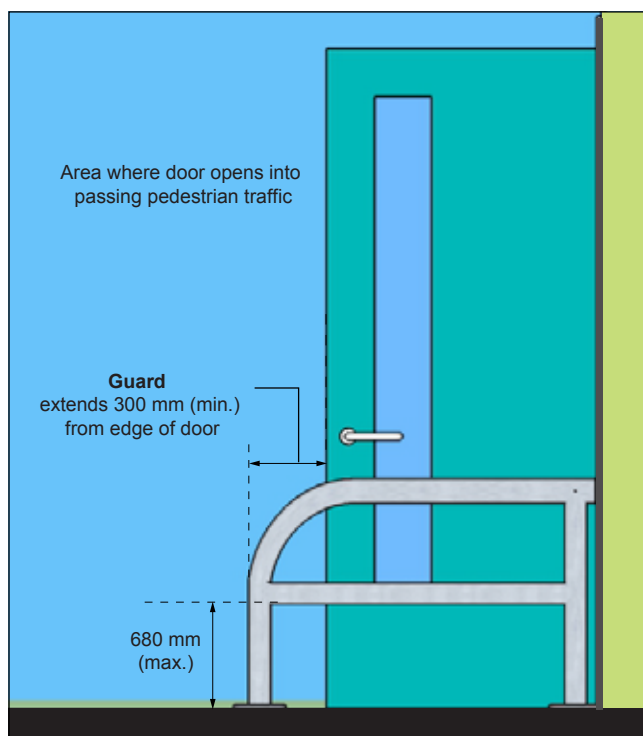

Figure 42: Guard at Door - Elevation View

Best Practice

Swinging doors equipped with power operators which are activated automatically and open into passing pedestrian traffic should also have a device (mat or other sensor) on the swing side to prevent the door from opening if someone is standing in the swing area.

Note

Provision of guards is typically required for exterior out-swinging power-assisted doors, where the door is automatically activated by a motion sensor and where the door may swing into high traffic areas.

4.2.10 Approach Clearances at Doors

The floor space requirements at swinging doors are dependent on how doors are approached (e.g., side or front) and on which side an individual approaches a door (push or pull sides). Clear floor space requirements for approach at different types of doors are summarized in **Table 5** with corresponding diagrams referenced.

Table 5: Minimum Clearance at Doors

Context	Floor Space Required in mm		
	Depth (min.)	Width (min.)	Space Beside Latch
Side-Hinged Door - Front Approach (Figure 43c)			
Pull side	1525	1600	600
Push side	1370	1250	300
Sliding Door (Figure 43d)			
Front approach	1370	1100	300
Side approach	1370	1550	600
Side-Hinged Door - Hinge Side Approach (Figure 43e)			
Pull side	1600	1600	600
Push side	1370	1830	450
Side-Hinged Door - Latch Side Approach (Figure 43f)			
Pull side	1370	1600	600
Push side	1370	1525	600
Folding Door			
Front approach	1220	n/a	n/a
Side approach	1220	n/a </td <td>n/a</td>	n/a
Recessed Door - Front Approach (Figure 43a and b)			
Pull side	1525	n/a	450
Push side	1220	n/a	300
Doorways Without Doors			
Front approach	1220	n/a	n/a
Side approach	1065	n/a	n/a

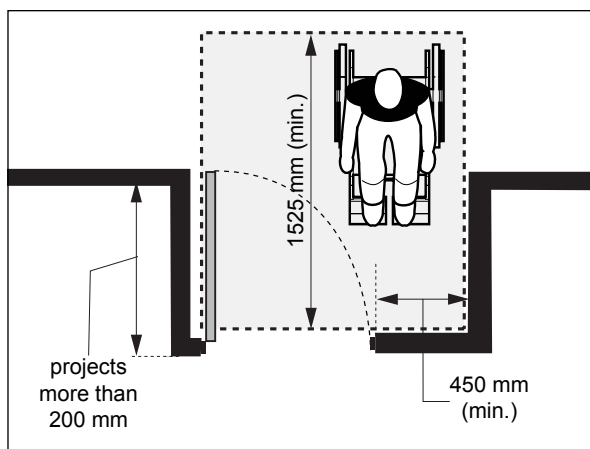

Figure 43a: Pull Side Approach at Recessed Side-Hinged Door - Plan View

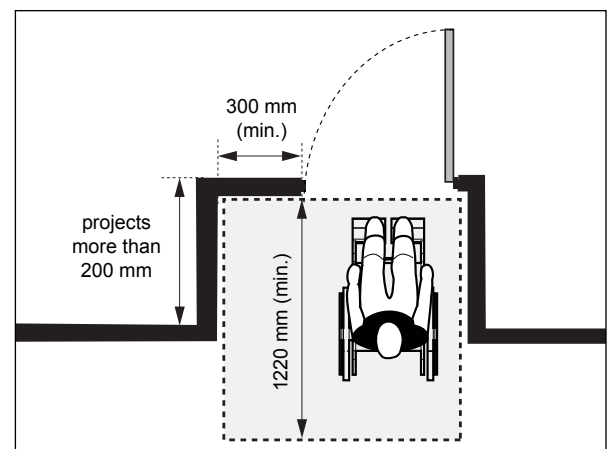

Figure 43b: Push Side Approach at Recessed Side-Hinged Door - Plan View

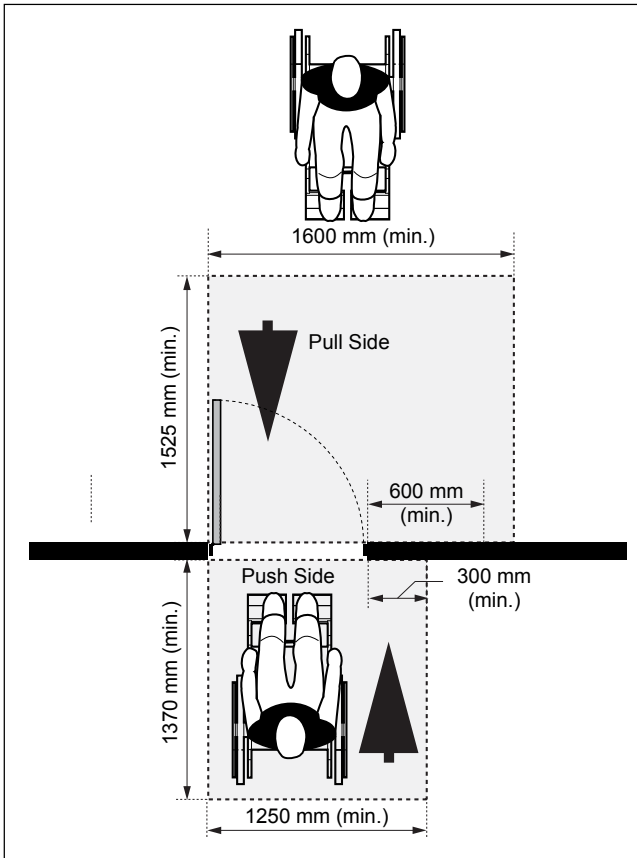

Figure 43c: Front Approach at Side-Hinged Door - Plan View

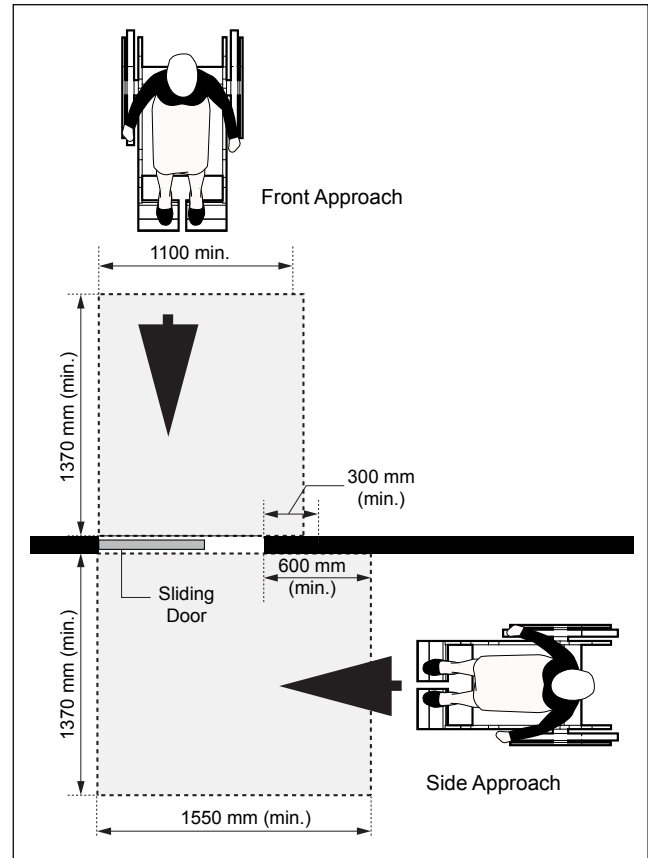

Figure 43d: Front and Side Approach at Sliding Door - Plan View

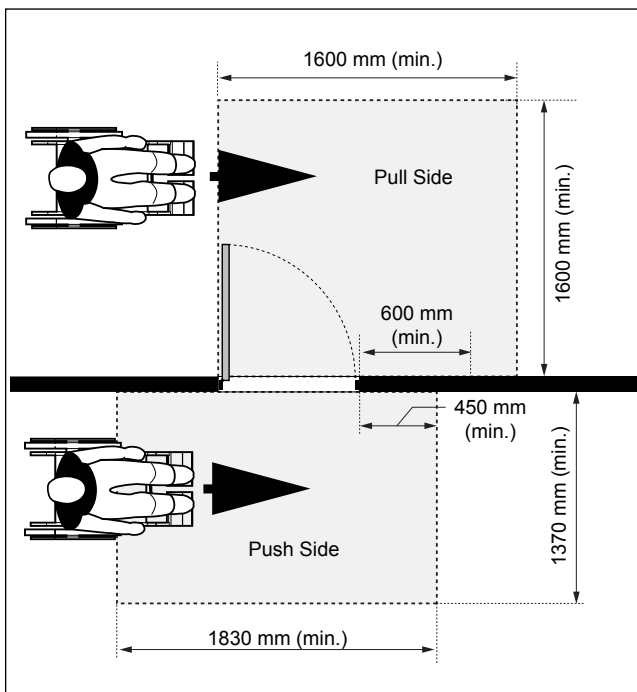

Figure 43e: Hinge Side Approach at Side-Hinged Door - Plan View

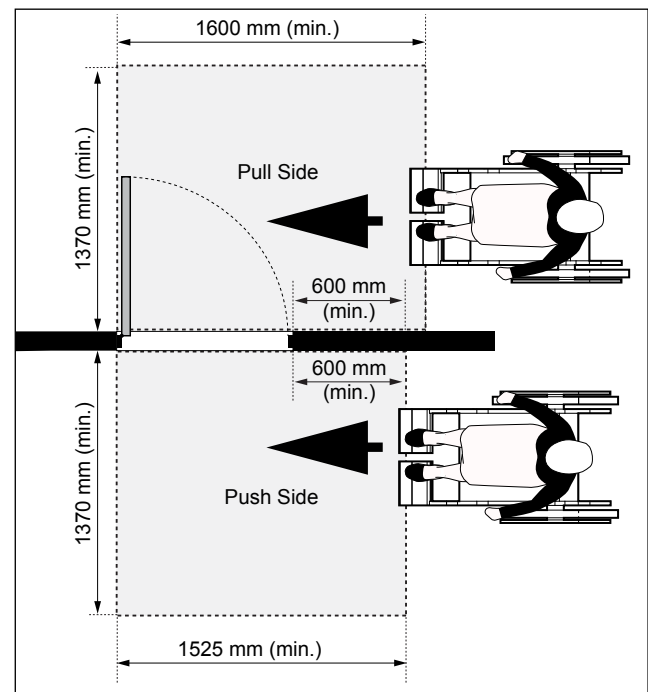

Figure 43f: Latch Side Approach at Side-Hinged Door - Plan View

Best Practice

Provide additional space for doors in series with doors operating independently in order to avoid a “wind tunnel effect”.

Ensure the design of vestibules provide suitable clear floor space (1500 mm minimum turning circle) for users of mobility aids where the vestibule may be used as a waiting area, for example at main entrances.

Note

Users of mobility aids must be able to move forward through a vestibule without the risk of being stuck between the two doors. Ensure power door operators are provided on both sides of both doors.

Best Practice

Frameless and fully glazed doors should not be used.

Where there is extensive glazing, consider providing a strip at a lower level, between 850 to 1000 mm high above finished floor level.

4.2.11 Doors in Series

Where doors in series form a vestibule:

- provide a distance between two doors in series of 1500 mm (minimum), plus the width of the door swinging into the space (**Figure 44**);
- where the doors into the vestibule are not aligned, provide a turning diameter of 1500 mm within the vestibule clear of any door swing; and
- arrange vestibule to allow the movement of users of mobility aids between doors.

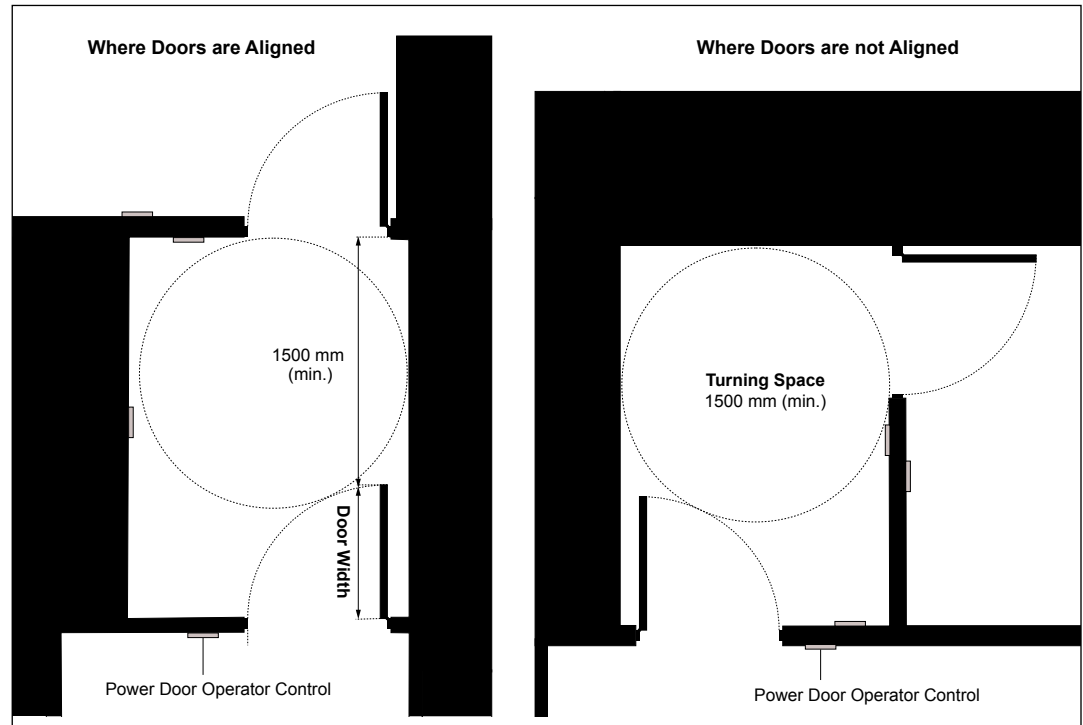

Figure 44: Doors in Series - Plan View

4.2.12 Glazed Doors or Doors with Sidelights

- provide a high tonal contrast between door frame and mounting surface or wall to ensure that when door is in the open position, persons with vision loss can identify edges upon approach;
- mark the edges of fully glazed doors (e.g., tempered glass without frame) with a high tonal contrast (e.g., exposed edges to be identified with a vertical safety strip, applied to cap the ends of any exposed glass panel); and
- provide a continuous opaque and high tonal contrast strip, decal or logo on fully glazed doors (**Figure 45**):
 - 50 mm (minimum) wide; and
 - mount at eye level between 1350 mm (minimum) and 1500 mm (maximum) high from floor level.

Note

Special designs can be used (e.g., logo or symbol) as long as they do not reduce the opacity, width and high tonal contrast of the strip when compared with the background.

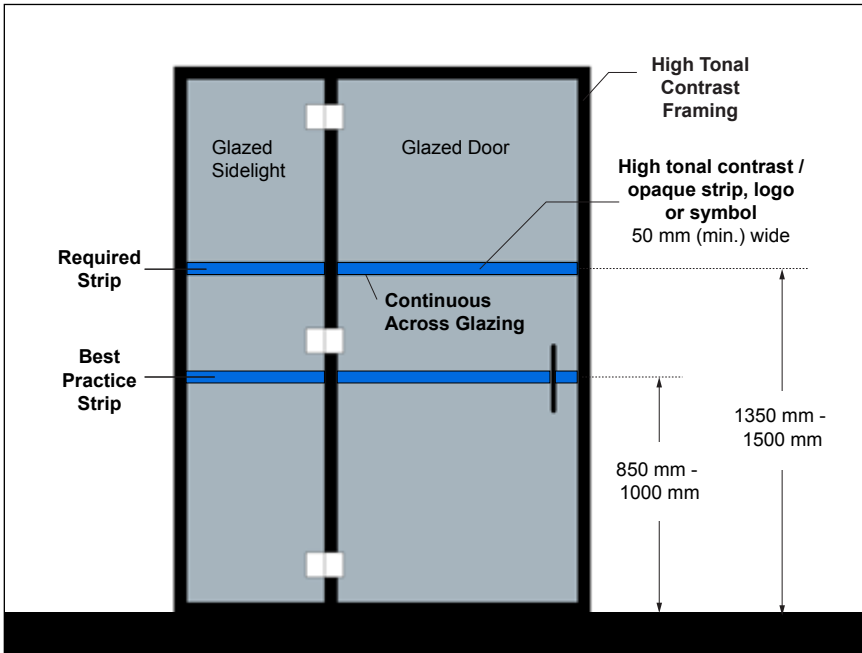

Figure 45: Glazed Doors - Elevation View

4.2.13 Vision Panels

- a. provide width of 75 mm (minimum); and
- b. mount bottom edge at a height of 900 mm (maximum) with side edge no more than 250 mm from latch side of the door (Figure 46).

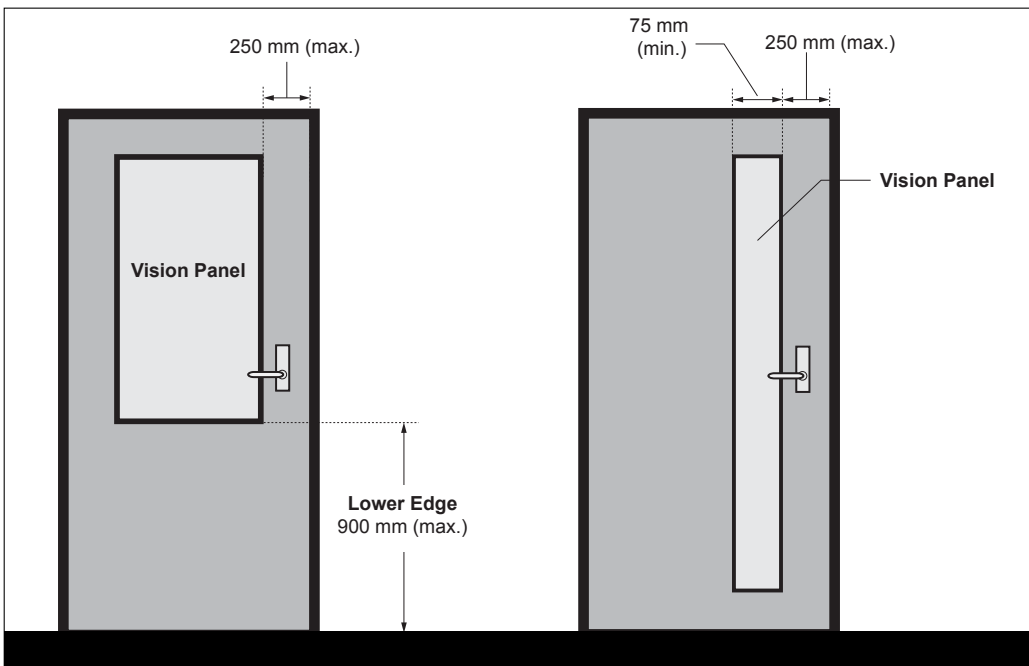

Figure 46: Vision Panels - Elevation View

A photograph of a modern, brightly lit interior hallway with a polished floor, glass walls, and tables with chairs in the background. The text "Interior Accessible Routes" is overlaid in white.

Interior Accessible Routes

4.3

Application

This section applies to accessible routes or paths of travel for pedestrians within a facility to provide access to elements, rooms or other occupiable spaces. Typical accessible routes are identified as corridors, hallways and other pedestrian circulation paths. These include connections between buildings, unless identified as exceptions.

All access to occupiable spaces to be accessible and conform to this section.

Where there is an elevation change within a path of travel, accessible routes may include ramps, sloped walkways and independently operated elevating devices as permitted (e.g., passenger elevators or lifts).

Reference

- Sec. 2.1 Ground and Floor Surfaces
- Sec. 2.2 Ramps
- Sec. 2.4 Guards and Handrails
- Sec. 2.5 Overhanging and Protruding Objects
- Sec. 2.6 Rest Areas
- Sec. 5.4 Acoustics
- Sec. 5.7 Lighting
- Sec. 5.8 Signage and Wayfinding

Exception

An accessible route or path of travel is not required in the following areas:

- Service rooms.
- Elevator machine rooms or other equipment, including service corridors to these rooms.
- Service spaces.
- Janitors' rooms.
- Crawl spaces and attics or roof spaces.
- Within portions of a floor area with fixed seats in an assembly occupancy, where these portions are not designated for users of mobility aids (e.g., spaces designated for wheelchair use, seats designated for adaptable seating, or spaces for the storage of wheelchairs and mobility assistive devices).
- Suites in residential occupancy that are in storeys other than the entrance storey and that have all entrance doors at floor levels that are not required to have an accessible path of travel.
- As required by jurisdictions having authority within a suite of residential occupancy.
- Portions of a floor area that are not at the same level as the entry level, provided amenities and uses provided on any raised or sunken level are accessible on the entry level by means of an accessible path of travel.

4.3.1 General Features

- a. ensure floor surfaces are stable, firm and slip-resistant;
- b. provide signage and wayfinding cues along interior accessible routes, including entrances and exits, to provide information and guidance for all users based on the type of facility;
- c. provide headroom clearance of 2100 mm (minimum);
- d. where headroom clearance along accessible routes is less than 2100 mm, provide guards to protect users from potential hazards;
- e. design public corridors to facilitate wayfinding by using architectural treatments and elements that can be used to differentiate main corridors from secondary corridors;
- f. provide lighting in accordance with Section 5.7 Lighting requirements, as applicable; and
- g. where accessible routes are more than 30 metres long, consider providing suitable rest areas.



Example of tactile floor surface to guide users with vision loss (Best Practice).



Where a structural column / support may be within an accessible route, a colour contrasted floor surface at base helps identify its location to prevent a potential bumping hazard.

4.3.2 Clear Width

- a. provide clear width of 1100 mm (minimum) (**Figure 47a**);
- b. in high traffic areas, provide clear width of 1500 mm (minimum);
- c. where clear width is less than 1600 mm along a route that exceeds 30 metres in length, provide a passing area of 1800 mm wide by 1800 mm (minimum) length at interval of no more than 30 metres; (**Figure 47b**)
- d. where clear width is reduced to 920 mm (minimum) for short indentations up to 600 mm (maximum), provide clear width of 1100 mm (minimum) beyond indentation and ensure indentations or reduced clear width is not repeated in a series (**Figure 47c**); and

Best Practice

Consider using texture and architectural treatments to enhance wayfinding.

Install convex mirrors at hallway intersections along an accessible route where the line of sight is obstructed.

Note

Architectural treatments may include the selection of products or materials, and other design techniques to improve aural experience in a space. The sound transmission depends on the reflection characteristics of finished material.

Best Practice

Avoid any projections (e.g., structural columns) along clear width of circulation corridors.

Exception

Minimum clear width of an accessible route can be reduced as described in other sections of this document:

- at doors / doorways;
- at stairs; and
- entry to elevating devices.

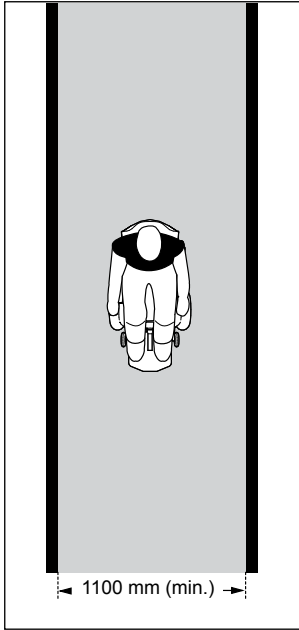

Figure 47a: Clear Width (Typical)

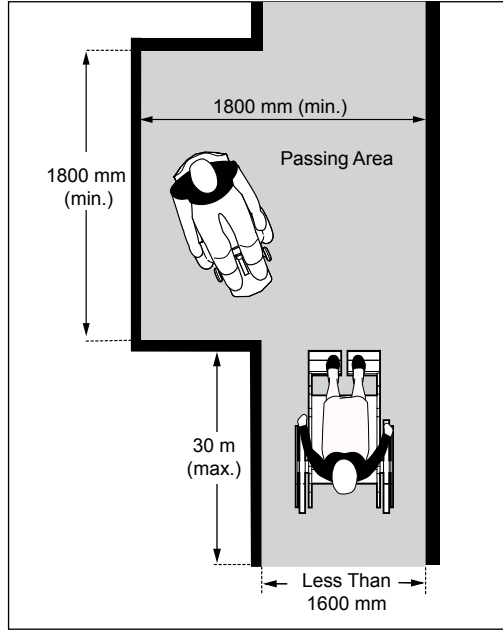

Figure 47b: Required Passing Area for Routes Greater than 30 metres if Width is less than 1600 mm

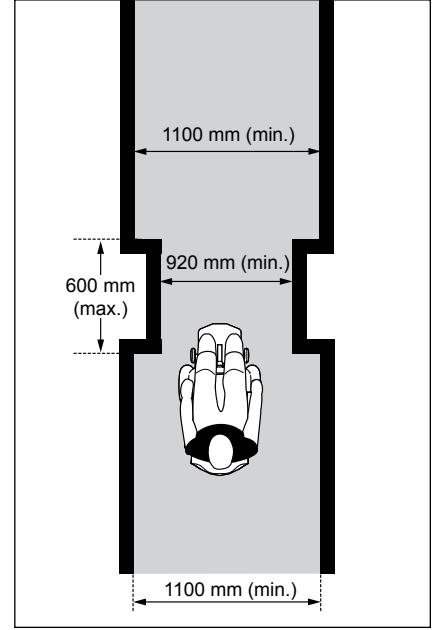

Figure 47c: Permitted Reduced Clear Width

Note

Where an obstacle is greater than 1200 mm wide, cutting the corners of the obstacle will provide additional manoeuvring space (Figure 48b).

- e. where an accessible route makes a 180 degree turn around an obstacle that is less than 1200 mm wide, ensure clear width of 1100 mm (minimum) is provided, when approaching and leaving the turn, and 1200 mm (minimum) at the turn (Figure 48a).

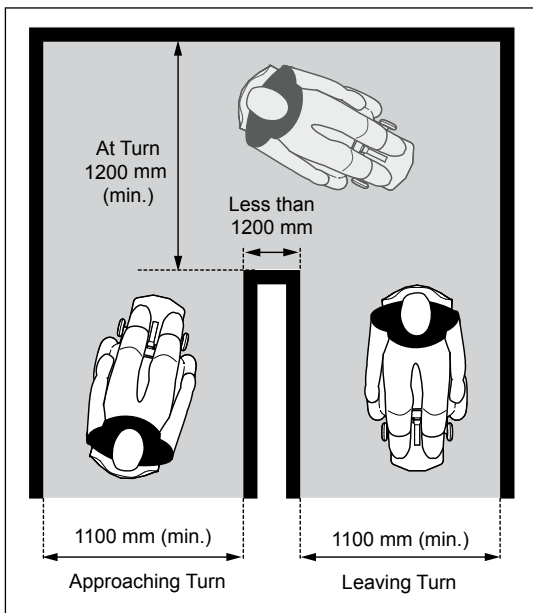

Figure 48a: 180 Degree Turn (Typical)

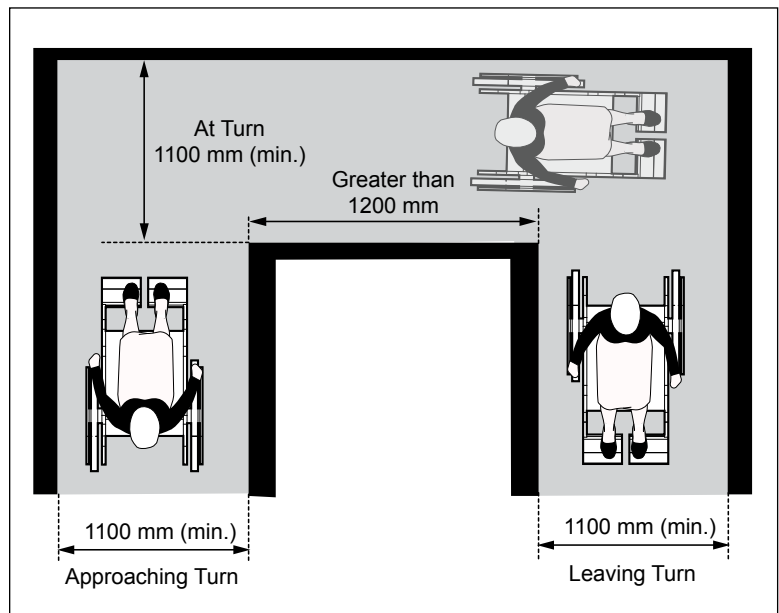

Figure 48b: 180 Degree Turn Around Obstacle greater than 1200 mm

4.3.3 Running and Cross-Slopes

4.3.3.1 Running Slope

- a. provide gradient of 1:20 (5%) (maximum) (**Figure 49**); and
- b. where gradient exceeds 1:20 (5%), ensure route is designed as a ramp.

4.3.3.2 Cross-Slope

- a. provide a gradient of 1:50 (2%) (maximum) (**Figure 50**).

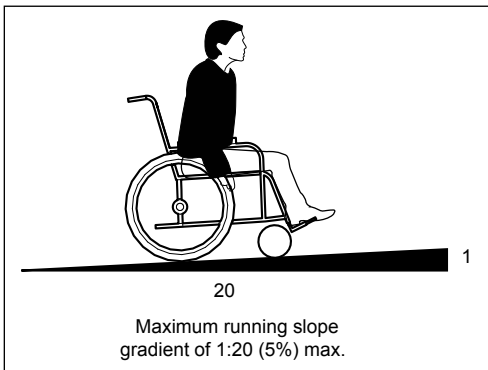

Figure 49: Running Slope

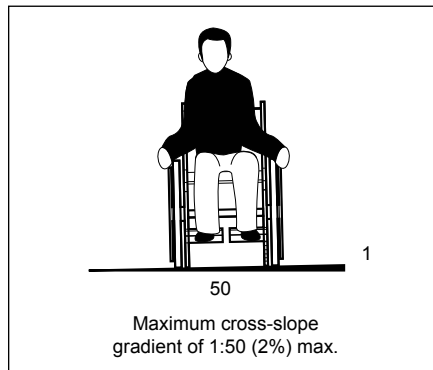

Figure 50: Cross-Slope

4.3.4 Changes in Level

Where edges of an accessible route are not level with adjacent surface:

- a. provide a high tonal contrast marking on the edge where the change in level is less than 200 mm;
- b. where the change in level is between 200 mm and 600 mm, provide a high tonal contrast curb or other barrier protection, 75 mm (minimum) high; and
- c. where the change in level is greater than 600 mm, provide guards.

Best Practice

Avoid level changes between an accessible route and adjacent surface.



Application

This section applies to elevating devices used to provide access between levels within a facility. Elevating devices include, but are not limited to:

- elevators;
- platform lifts;
- inclined lifts;
- moving walkways; and
- escalators.

All new passenger elevators, lifts, moving walkways and escalators provided in multi-storey facilities must comply with the current Ontario Building Code and other applicable requirements identified in the most up-to-date versions of:

- CAN / CSA B44: Safety Code for Elevators and Escalators (Appendix E);
- CAN / CSA B355: Lifts for Persons with Physical Disabilities; and
- CAN / CSA B651: Accessible Design for the Built Environment.

Best Practice

Platform lifts are not recommended in new construction due to limited size of platforms and weight restriction which typically does not accommodate larger mobility aids.

Limited use / limited application (LU/LA) elevators are also not recommended for new construction due to the limited size of interior platform and other operating features. For existing facilities where LU/LA elevators are being upgraded, refer to applicable CSA standards.

Note

Detailed accessibility criteria for elevating devices are not included in these Standards including signage requirements. The City recommends direct referencing of other applicable and governing standards.

Exception

Freight elevators are not required to comply with this section, unless the only elevators provided are used as combination passenger and freight elevators for use by the public and employees.

When retrofitting elevating devices at existing facilities, the City will review options in detail, on a case by case basis, recognizing there may be other factors to consider, including physical or structural constraints.

4.4.1 Passenger Elevators

Key design features for passenger elevators are summarized as follows: (Note: refer to CSA standards for detailed criteria)

- a. ensure minimum elevator cab dimension and clear opening width of door are as identified in **Table 6** below:

Table 6: Minimum Dimensions for Elevator Car and Door Clear Width

All dimensions are in millimeters (mm).

Door Location	Door Clear Width	Inside Car (Side to Side)	Inside Car (Back Wall to Front Return)	Inside Car (Back Wall to Inside Face of Door)
Centred	1065	2030	1295	1370
Side (Off-Centre)	915*	1725	1295	1370
Any	915*	1370	2030	2030
Any	915*	1525	1525	1525
Minimum Dimension of LU / LA (limited use / limited application) elevators				
Any	815	1065	1370	Not Specified

Note: * A tolerance of minus 16 mm shall be permitted.

Source: Information in this Table was adapted from Annex E of CSA-B651-12, "Elevator Requirements for Persons with Physical Disabilities". As identified in this document, information is based on Table 407.2.8 in ICC /ANSI A117.1 (metric values only).

- b. Provide hall call buttons, with visual indicators to identify when car call has been registered and answered, mounted between 890 to 1200 mm from floor, measured to centreline of button;
- c. Ensure clear floor space in front of hall call buttons of 760 mm wide by 1220 mm depth (minimum);
- d. Visual and audible signals at each hoistway entrance to indicate which car is answering a call and its direction of travel. Audible signals to sound once for the "up" direction and twice for the "down" direction, or alternatively, provide verbal annunciators that are bilingual;
- e. Entrance doors with door re-opening device that senses objects or person in path of travel of closing door (e.g., automatic sensors). Provide a tactile (e.g., both raised and braille, tonal contrast surface) elevator car identification sign, with characters 50 mm high, immediately below the hoistway entrance floor designation;
- f. Interior car operating controls to be mounted 1220 mm high (maximum, to centreline of control preferred), or 1370 mm high is permitted, for cars with more than 16 openings, where parallel approach to controls is also provided for users of mobility aids;

Note

Platform lifts are only allowed where alternatives are not considered feasible (e.g., primarily retrofit scenarios). Lifts that require key access and / or an attendant to operate are not recommended.

- g. Audible and visual car floor location indicators. Audible signal to be a bilingual verbal announcement that identifies floor at which car has stopped; and
- h. Emergency two-way communication system (e.g., a hands-free speaker phone is preferred), with operating controls mounted at 1220 mm high (maximum) from floor, with accessible features (e.g., push button operation) and visual indicator identifying when the system has been activated and the emergency call has been received (e.g., to identify “help is on the way” for users with hearing loss).



Tactile elevator car identification sign.



Elevator sensor door and floor registration buttons.



4.5

Application

This section applies to washroom facilities and elements within a site and facility including, but not limited to:

- multiple-occupancy washrooms;
- universal washrooms; and
- change rooms with washroom features.

Refer to Table 7 and Table 8 in sub-section 4.5.1 Provision and Locations for minimum number of Universal Washrooms and Accessible Water Closet Stalls to be provided in a building in which washrooms are required as per subsection 3.7.4 of the Ontario Building Code.

Reference

- Sec. 2.1 Ground and Floor Surfaces
- Sec. 2.5 Overhanging and Protruding Objects
- Sec. 4.2 Doors and Doorways
- Sec. 4.3 Interior Accessible Routes
- Sec. 5.1 Controls and Operating Mechanisms
- Sec. 5.6 Fire and Life Safety Systems
- Sec. 5.7 Lighting
- Sec. 5.8 Signage and Wayfinding

Note

If retrofitting multiple occupancy washrooms with accessible water closet stalls is not possible, identifying additional space for providing a universal washroom is recommended.

Universal washrooms allow the greatest flexibility, including larger floor space for people who require assistance and may be accompanied by a caregiver or companion, as well as to accommodate larger mobility aids such as power wheelchairs and scooters.

Best Practice

Provide at least one universal washroom on every occupied floor of a facility.

Note

Where one water closet is required for males and one water closet is required for females, the following may be provided:

(1) one universal washroom; and

(2) one washroom containing one water closet to be used by both sexes provided the door to the room can be locked from the inside.

Best Practice

Wherever possible, consider the use of privacy walls or specialized configuration of entrance vestibules to avoid the need for doors and power door operators.

4.5.1 Provision and Locations

- provide universal washrooms in accordance to **Table 7**;
- provide minimum number of accessible water closet stalls per washroom in accordance to **Table 8**;
- locate centrally within a facility along an accessible route, within 45 metres (maximum) of regular washrooms; and
- where washrooms are not accessible, provide directional signage to indicate location of nearest accessible washroom on the same floor.

Table 7: Minimum Number of Universal Washrooms per Building

Number of Storeys in Building	Minimum number of Universal Washrooms per Building
1-3	1
4 - 6	2
Over 6	3, plus 1 for each additional increment of 3 storeys in excess of 6 storeys

Table 8: Minimum Number of Water Closet Stalls Required to be Accessible

Number of Water Closets per Washroom	Minimum Number of Accessible Water Closet Stalls per Washroom
1-3	0, where a universal washroom is provided on the same floor level within 45 m of the washroom, or 1, where a universal washroom is not provided on the same floor level within 45 m of the washroom
4 - 9	1
10 - 16	2
17 - 20	3
21 -30	4
Over 30	5, plus 1 for each additional increment of 10 water closets per washroom in excess of 30 water closets per washroom

4.5.2 Multiple Occupancy Washrooms

For multiple occupancy washrooms with accessible water closet stalls:

- identify clearly with signage, indicating male or female where applicable, with other accessibility features (e.g., braille, tactile, International Symbol of Accessibility);
- where doors are provided at washroom entrance, provide a clear width of 860 mm (minimum), when the door is in the open position and equip with power door operators;
- ensure lighting level is evenly distributed in accordance with Section 5.7 Lighting requirements, as applicable;

- d. ensure minimum clearance of 1700 mm between the inside face of an in-swinging entrance door and the outside face of an adjacent water closet stall;
- e. ensure minimum clearance of 1400 mm between outside wall of stall and any wall-mounted fixtures or other obstructions (**Figure 51**);
- f. provide a clear floor space of 1500 mm by 1500 mm (minimum) in front of the accessible water closet stall;
- g. ensure a clear turning diameter of 1500 mm (minimum) is provided inside washroom circulation area, 500 mm (maximum) of which may be under the lavatory to allow users of mobility aids to make a 180° turn (**Figure 51**);
- h. ensure floor surfaces are slip-resistant, with a maximum slope of 1:50 (2%);
- i. provide accessible lavatories with washroom amenities, as identified in this section;
- j. provide accessible water closet stalls with suitable clear floor space, as identified in this section;
- k. install audible and visual fire alarm system; and
- l. install any drains out of the path of travel.

Best Practice

Consider providing a larger clear turning diameter of 1700 mm or greater inside washroom circulation area.

Note

In a storey that is not required to have an accessible path of travel, ensure at least one ambulatory water closet is provided.

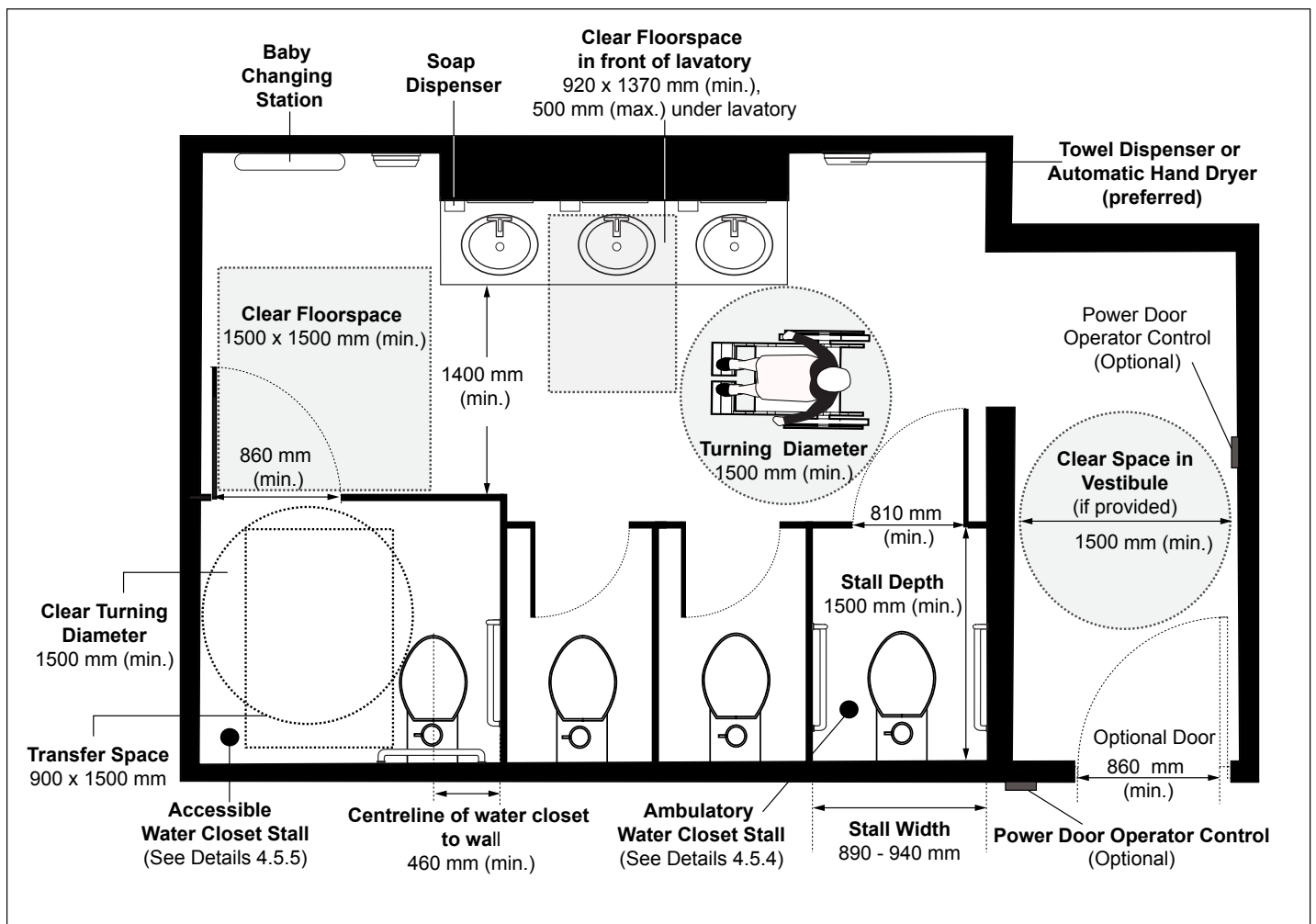

Figure 51: Example of Multiple Occupancy Washroom Layout

Best Practice

Provide both a hand dryer and a paper towel dispenser, where space is available.

Provide a fold-down grab bar mounted on the transfer side of the water closet for additional support.

4.5.3 Universal Washrooms

Where universal washrooms are provided:

- a. locate in the same vicinity as other washrooms (e.g., Men's & Women's multiple occupancy washrooms) along the shortest accessible route;
- b. identify clearly with bilingual signage, including unisex pictogram (e.g., Male and Female) and the International Symbol of Accessibility;
- c. provide accessible entrance door:
 - i. with clear width of 860 mm (minimum), when the door is in an open position;
 - ii. equip with power door operator;
 - iii. provide locking mechanism that can be locked from the inside and released from the outside, in case of emergency;
 - iv. mount graspable operating and locking mechanisms 900 to 1000 mm above floor;
 - v. if it is an outward swinging door, provide door pull 140 mm long (minimum), located on the inside so that its midpoint is between 200 mm and 300 mm from the latch side of the door; and
- d. ensure internal dimension between walls is no less than 1700 mm (2500 mm preferred);
- e. ensure a clear turning diameter of 1700 mm (minimum) is provided inside the universal washroom (**Figure 52**);
- f. ensure floor surface is firm, stable and slip-resistant;
- g. provide one accessible lavatory with other washroom amenities including but not limited to mirror, soap dispenser, paper towel dispenser, automatic hand dryer (preferred), coat hook, and toilet paper dispenser as identified in this section;
- h. provide one accessible water closet with suitable rear and side grab bars (e.g., horizontal, L-shaped and fold-down grab bars) as identified in this section;
- i. provide motion sensor for automatic illumination of interior;
- j. provide lighting in accordance with Section 5.7 Lighting requirements, as applicable;
- k. install audible and visual fire alarm systems;
- l. provide a clear floor space 810 mm wide by 1830 mm long in each universal washroom for an adult-size change table (**Figure 52**);
- m. where the clear floor space provided for an adult-size change table is adjacent to a wall, ensure reinforcement is installed in the wall to permit the future installation of the change table;
- n. where an adult-size change table is installed, ensure a clear floor space of 760 mm wide by 1500 mm long, parallel to the long side of the adult-size change table;

- o. where installed, ensure baby changing stations and / or adult-size change tables adhere to the requirements identified in sub-section 4.5.9.2;
- p. provide shelf as identified in sub-section 4.5.8.1;
- q. ensure drains are installed out of the path of travel; and
- r. provide an emergency call system with the following features:
 - i. consists of visual and audible signal devices both inside and outside of the washroom that are activated by a push control device inside the washroom;
 - ii. includes an emergency bilingual sign that contains the words “IN THE EVENT OF AN EMERGENCY PUSH EMERGENCY BUTTON AND AUDIBLE AND VISUAL SIGNAL WILL ACTIVATE” in letters at least 25 mm high with a 5 mm stroke and that is posted above the emergency button; and
 - iii. where facilities have the capacity and where staff is available, ensure the call system is linked to a display panel at a reception / information counter or to a centrally monitored station (e.g., security desk).

Note

Emergency call systems with a cancellation feature to turn off the alarm when it is accidentally activated is preferred.

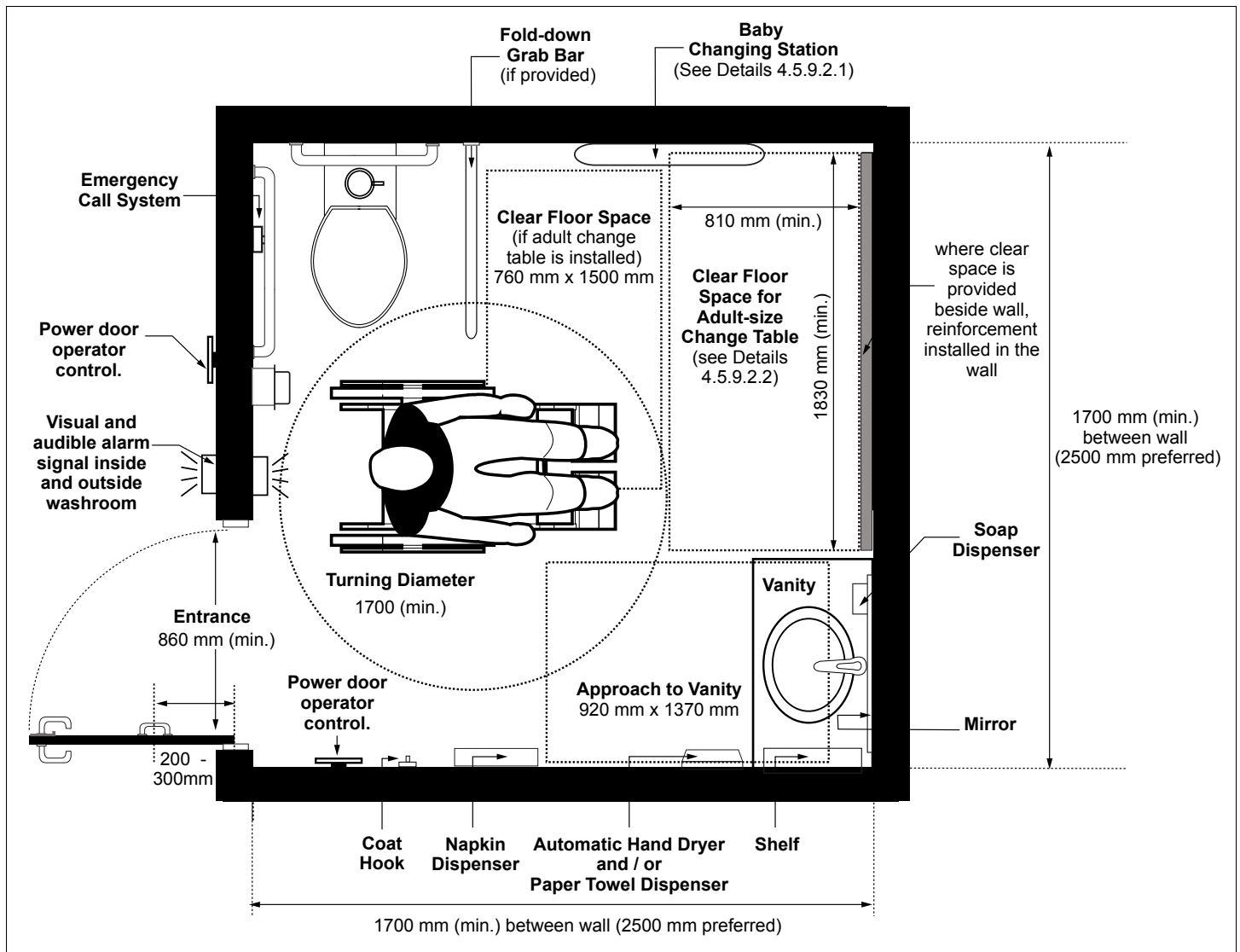

Figure 52: Universal Washrooms

Note

Ambulatory water closet stalls can be identified with a sign that includes a pictogram or symbol of a person with a cane.

4.5.4 Ambulatory Water Closet Stalls

Where ambulatory water closet stalls are provided for users with limited mobility who do not use wheeled mobility aids (e.g., canes or crutches):

- a. ensure stall depth is 1500 mm (minimum), with 890 to 940 mm width;
- b. provide a stall door:
 - i. with clear width of 810 mm (minimum);
 - ii. that swing outward, unless the minimum dimensions of the stall identified above are not located within the door swing;
 - iii. with spring-type or gravity hinges so that the door closes automatically;
 - iv. capable of being latched from the inside and released from the outside in case of an emergency;
 - v. with a door pull on both sides of the door, near the latch side of the door, located at a height not less than 900 mm and not more than 1000 mm above the finished floor;
- c. equip with a water closet located so that its centre line is centred between the partition walls (**Figure 51**);
- d. install L-shaped grab bars, as identified in this section, on each side of the water closet;
- e. provide a sign on the door that indicates that the stall is suitable for users who may require grab bar assistance;
- f. install a coat hook as identified in this section.

Best Practice

Provide a larger accessible stall that includes a lavatory inside with required amenities and floor space clearances.

Note

Emergency call systems with a cancellation feature to turn off the alarm when it is accidentally activated is preferred.

4.5.5 Accessible Water Closet Stalls

Where accessible water closet stalls are provided in multiple occupancy washrooms:

- a. mark accessible water closet stall with International Symbol of Accessibility;
- b. provide a clear turning space of 1500 mm diameter (minimum) (**Figure 53**); and
- c. provide an emergency call system with the following features:
 - i. consists of visual and audible signal devices both inside and outside of the washroom that are activated by a push control device inside the washroom;
 - ii. includes an emergency bilingual sign that contains the words "IN THE EVENT OF AN EMERGENCY PUSH EMERGENCY BUTTON AND AUDIBLE AND VISUAL SIGNAL WILL ACTIVATE" in letters at least 25 mm high with a 5 mm stroke and that is posted above the emergency button; and
 - iii. where facilities have the capacity and where staff is available, ensure the call system is linked to a display panel at a reception / information counter or to a centrally monitored station (e.g., security desk).

4.5.5.1 Stall Doors

- a. when door is in an open position, provide clear width of 860 mm (minimum);
- b. ensure the door is aligned with water closet transfer space (e.g., door is positioned on opposite side of water closet) (**Figure 54**);
- c. ensure door swings outward, unless a clear floor area of 820 mm wide by 1440 mm long (minimum) is provided within the stall or enclosure to permit the door to be closed inside without interfering with the mobility device;
- d. ensure door is self-closing with spring-type or gravity hinges, so that when at rest, the door will be ajar not more than 50 mm beyond the jamb;
- e. provide accessible locking mechanisms, with stall capable of being locked from the inside by a control that is operable with a closed fist;
- f. ensure door can be released from the outside in case of emergency; and
- g. provide D-type door pull on inside and outside of the door (**Figures 53 & 54**):
 - i. ensure hardware provides high tonal contrast with mounting surface;
 - ii. provide length of 140 mm (minimum);
 - iii. mount horizontally 900 to 1000 mm high from floor, centered 120 to 220 mm from latch side of the door; and
 - iv. mount horizontally on the inside of an out-swinging door, with its centered 200 to 300 mm from the hinge edge.

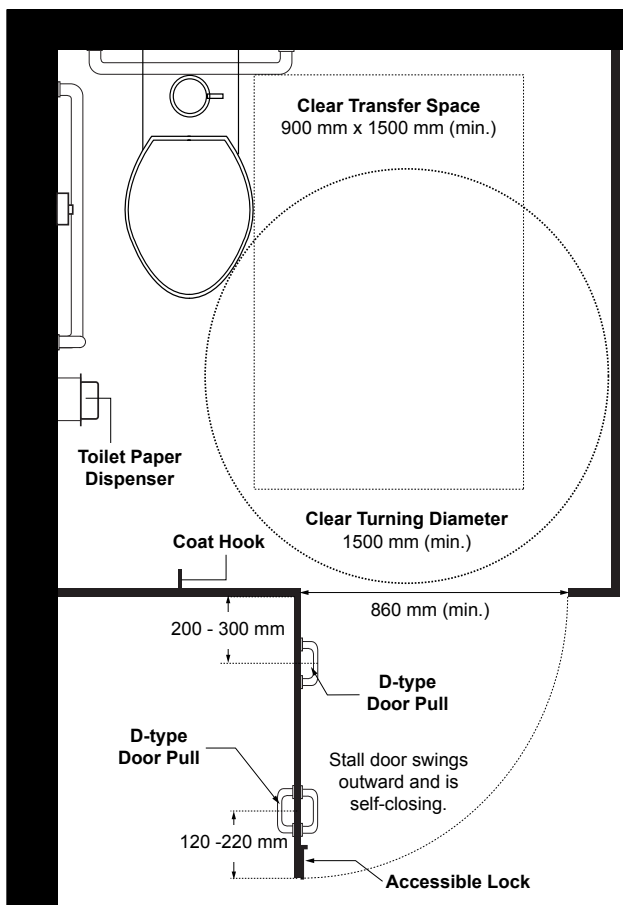

Figure 53: Water Closet Stall - Space Requirements

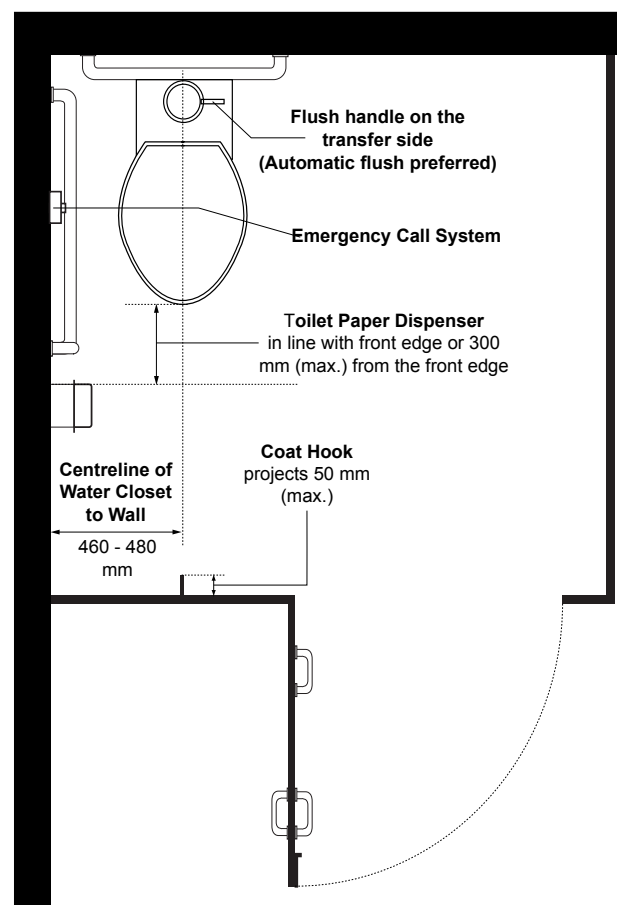

Figure 54: Water Closet Stall Features

Best Practice

Wall hung water closets are preferred because they provide additional space at toe level.

Automatic flush controls are recommended for accessible water closets (e.g., sensor activated).

Note

The clear transfer space is measured from side surface of water closet to stall partition / wall, or side of adjacent vanity, if applicable.

Best Practice

Space of 100 mm is recommended between grab bar and toilet paper dispenser.

Where large toilet paper dispensers are used, ensure they are suitably mounted and do not obstruct the use of the adjacent grab bar.

Note

Grab bars with knurled finish are not acceptable for use.

4.5.6 Water Closets

- a. mount seat between 430 mm and 485 mm high from floor (**Figure 55**);
- b. install water closet so that:
 - i. the centreline of water closet from any adjacent side wall is between 460 mm and 480 mm and an unobstructed transfer space of 900 mm wide by 1500 mm deep (minimum) is provided on the other side of the water closet (**Figure 53**); or
 - ii. a clear transfer space of at least 900 mm wide and 1500 mm deep is provided on each side of the water closet;
- c. provide a back support where there is no seat cover / lid or tank, and where there is a tank, ensure tank lid is securely attached.;
- d. ensure seat is not spring activated;
- e. provide internal extension guards that will not allow the seat to slide;
- f. mount toilet paper dispenser below the grab bar, 600 to 800 mm high from floor, in line with front edge or not more than 300 mm from the front edge of the water closet;
- g. install lever flush control or other flush control operable with a closed fist (e.g., push button control) on transfer side; and
- h. install at least one coat hook mounted at 1200 mm (maximum) high from floor, on a side wall and projecting 50 mm (maximum) from mounting surface.

4.5.7 Grab Bars

Where grab bars are provided:

- a. ensure surface is non-abrasive and slip-resistant (e.g., peened finish);
- b. ensure a high tonal contrast between grab bar and mounting surfaces;
- c. provide grasping surface that is circular in shape, with diameter between 35 mm and 40 mm;
- d. ensure clear space of 38 mm (minimum) and 50 mm (maximum) between mounting surface and the inside surface of the grab bar;
- e. mount securely to withstand a force of 1.3 Kilonewtons applied in all directions; and
- f. ensure grab bar does not rotate within its fittings.

4.5.7.1 Horizontal Grab Bars

- ensure length of 600 mm (minimum) ;
- mount between 840 and 920 mm high from floor level, centered behind water closet; and
- where water closet has a water tank, mount grab bar 150 mm above the tank (**Figure 55**).

4.5.7.2 L-shaped Grab Bars

- ensure length of 760 mm (minimum) for both vertical and horizontal components (**Figure 56**);
- mount vertical component 150 mm (maximum) from front of water closet; and
- mount horizontal component 750 mm high above floor.

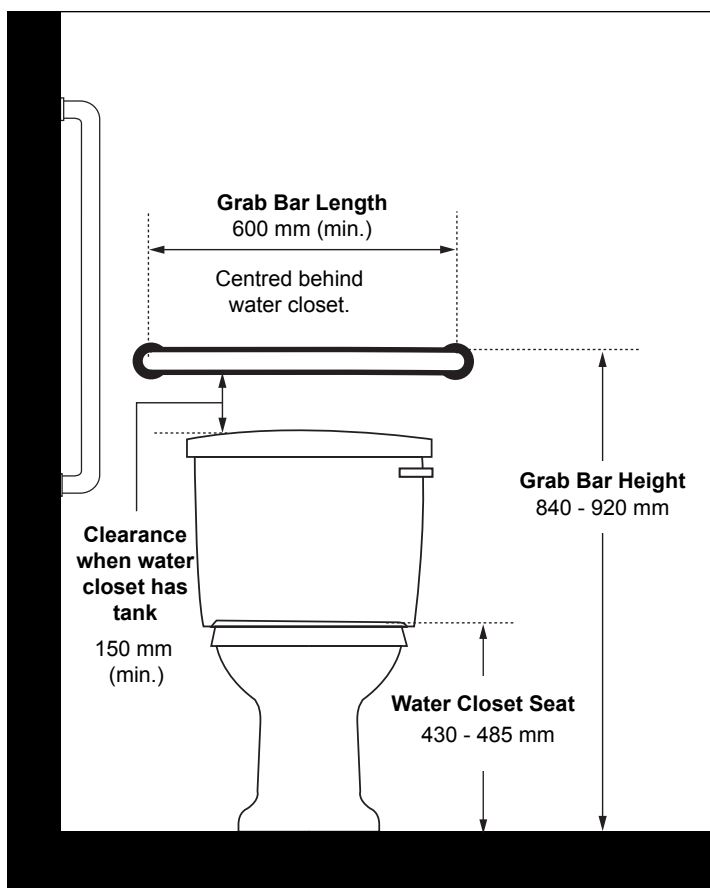

Figure 55: Horizontal Grab Bar (Water Closet with Water Tank)

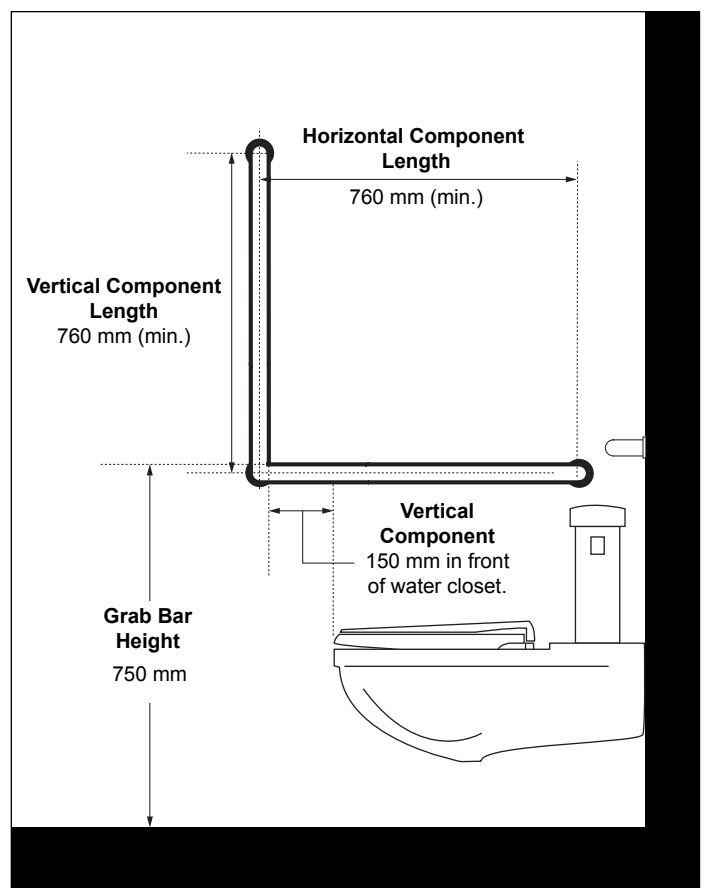

Figure 56: L-shaped Grab Bar (Wall Hung Water Closet with Flush Valve)

Note

Fold-down grab bar is permitted to encroach into the turning space or clear transfer space.

4.5.7.3 Fold-Down Grab Bars

Where fold-down grab bars are provided:

- mount on the wall behind the water closet;
- locate on transfer space side;
- ensure length of 760 mm (minimum);
- mount between 390 mm and 410 mm from centreline of water closet (**Figure 57a**);
- mount with the horizontal component at 750 mm high from floor level (**Figure 57b**);
- ensure force required to pull down grab bar is no more than 22 Newtons; and
- where transfer space is provided on both sides of the water closet, provide a fold-down grab bar on each side.

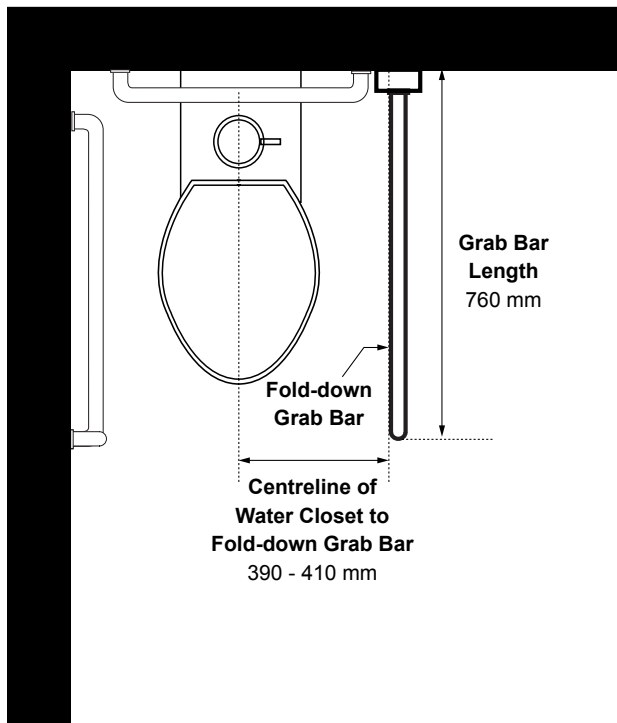

Figure 57a: Fold-down Grab Bar - Plan View

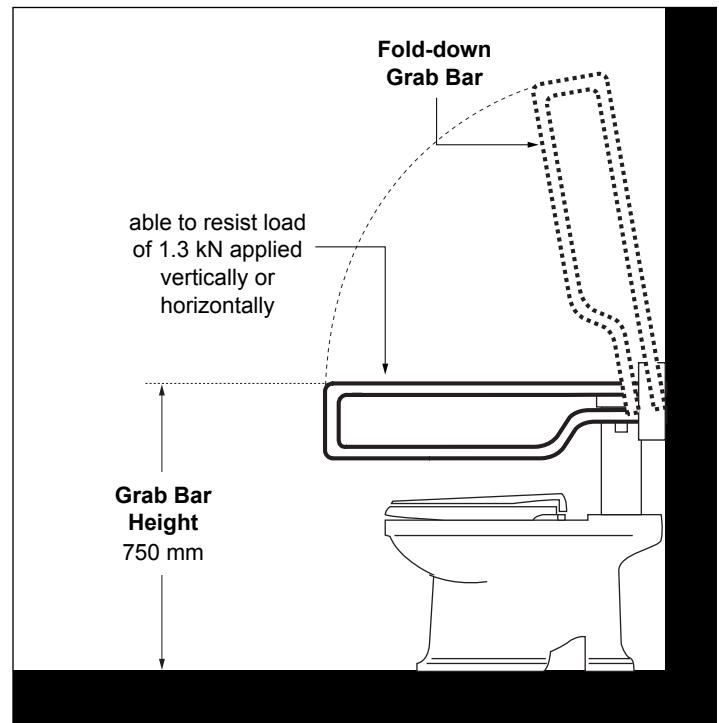

Figure 57b: Fold-down Grab Bar - Elevation View

4.5.8 Lavatories

Provision of at least one accessible lavatory is required in each accessible washroom facility:

- ensure centreline of lavatory is 460 mm (minimum) from adjacent side wall;
- ensure top surface is continuous and provides a high tonal contrast with adjacent wall surfaces;
- mount top surface of lavatory 820 to 840 mm high above floor (**Figure 58a**);

- d. provide clearances underneath lavatory no less than (**Figure 58a**):
 - i. 920 mm wide;
 - ii. 735 mm high at front edge;
 - iii. 685 mm high at 205 mm back from front edge; and
 - iv. 350 mm toe space height from a point 300 mm back from the front edge to the wall;
- e. provide automatic control or lever-type faucet without spring loading, located no more than 485 mm depth from edge of basin (**Figure 58a**);
- f. mount soap dispenser at 1200 mm (maximum) high above floor and 610 mm (maximum), measured horizontally from the edge of the lavatory;
- g. provide minimum clear floor space of 920 mm wide by 1370 mm deep (minimum), of which 500 mm depth is allowed under the lavatory (**Figure 58b**);
- h. ensure water temperature is controlled to a maximum of 43°C; and
- i. ensure water pipes are covered or insulated below lavatories.

Best Practice

Automatic faucet control is preferred or a single lever faucet handle, 75 mm long (minimum).

An offset trap and drain below accessible lavatories enhances required clearances and knee space available.

4.5.8.1 Shelves

- a. mount 1100 mm (maximum) high above floor;
- b. ensure shelves do not project more than 100 mm from mounting surface along an accessible path of travel (**Figure 58b**); and
- c. where provided at lavatory, mount 200 mm (maximum) above top surface of lavatory.

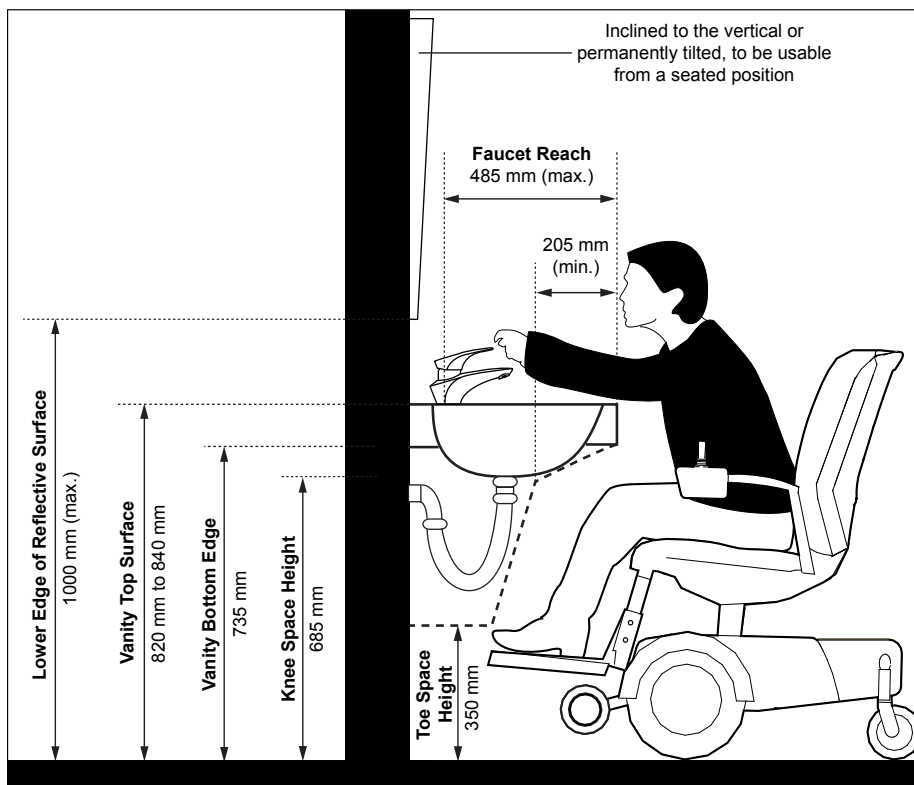

Figure 58a: Lavatories - Section View

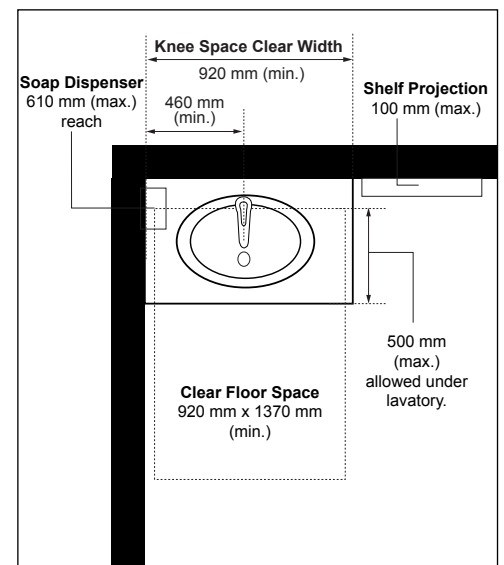

Figure 58b: Lavatories - Plan View

Best Practice

Automatic controls are preferred as they are easy to use by a wider range of users and have improved hygienic performance.

A single full length mirror can accommodate a greater number of people, including children. In order for mirrors to be usable by people who are ambulatory and people who use wheeled mobility devices, ensure the top edge of mirrors is 1880 mm (minimum) from the floor or ground.

Where tilted mirrors are provided, ensure they are permanently tilted for use at all times from a seated position, by children or users of shorter stature.

4.5.9 Washroom Amenities

Washroom amenities include, but are not limited to, hand dryers, paper towel dispensers, soap dispensers, waste bins, mirrors, changing stations and tables.

Where provided:

- a. ensure wall mounted amenities do not project more than 100 mm from wall along an accessible path of travel;
- b. provide high tonal contrast between amenities and mounting surfaces;
- c. ensure any operating controls are mounted between 900 mm and 1200 mm high above floor, operable with a closed fist (**Figure 59**);
- d. ensure the dispensing height of washroom amenities is between 900 mm and 1200 mm;
- e. where amenities are mounted at lavatories (e.g., hand dryers, paper towel dispensers, soap dispensers), install at 1200 mm (maximum) high, 610 mm (maximum) measured horizontally from the edge of the lavatory;
- f. provide minimum clear floor space of :
 - i. 920 mm wide by 1370 mm deep to allow front approach; and
 - ii. 1525 mm wide by 920 mm deep to allow side approach.

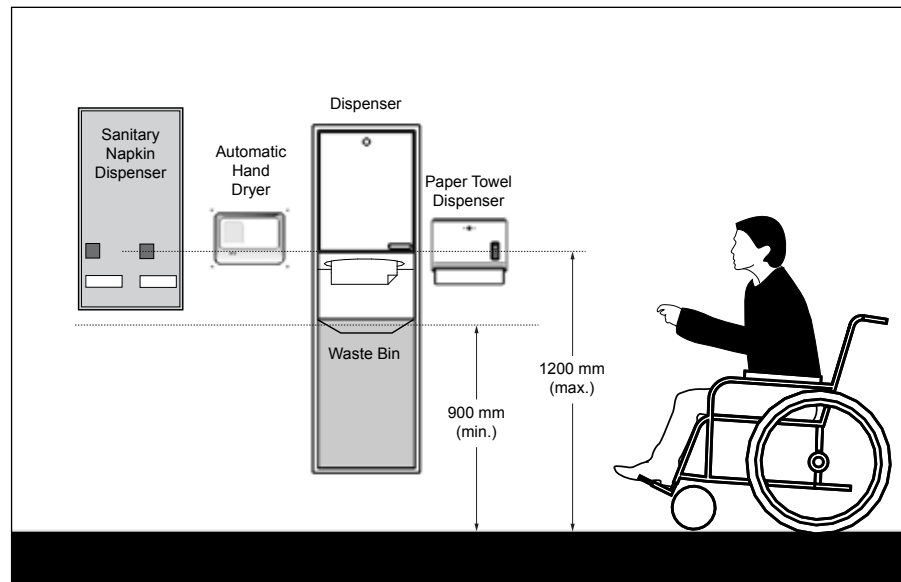

Figure 59: Typical Washroom Amenities

4.5.9.1 Mirrors

- a. mount with the bottom edge of the reflecting surface at 1000 mm (maximum) high above floor (**Figure 58a**) or inclined to the vertical to be usable from a seated position;
- b. ensure lighting level over mirrors does not create reflected glare; and
- c. where full length mirrors are provided, ensure they are not installed where they will reflect path of travel and cause confusion for users.

4.5.9.2 Changing Stations and Tables

4.5.9.2.1 Baby Changing Stations

- a. where provided, ensure at least one is accessible for users with disabilities, with unit placed in a location that does not obstruct adjacent paths of travel when in use and positioned in close proximity to a lavatory and waste receptacle;
- b. ensure suitable clear floor space of:
 - i. 920 mm wide by 1370 mm depth is provided for a forward approach;
 - ii. 1525 mm wide by 920 mm depth for a side approach (whether standing or seated) in front of unit;
- c. ensure the required floor clearance for changing station does not overlap with floor clearances of other fixtures, when the changing station is folded up;
- d. mount with the highest edge or component of the station between 730 and 865 mm;
- e. ensure knee clearance of 685 mm high and 480 mm depth is provided;
- f. where a folding changing station is provided, ensure projection from wall of 100 mm (maximum) when in folded position and located along accessible path of travel; and
- g. where a folding-type is provided, ensure operating control:
 - i. is mounted no more than 1200 mm (**Figure 60a**);
 - ii. operable with a closed fist and without tight grasping, pinching of fingers or twisting of wrist.

Best Practice

Ensure baby changing stations are not located in accessible water closet stalls, especially in high use washrooms.

Universal washrooms designed with larger floor space are more suitable to accommodate changing stations, tables and other attendant care amenities (e.g., shelving).

Note

Baby changing stations can be fixed or the folding type.

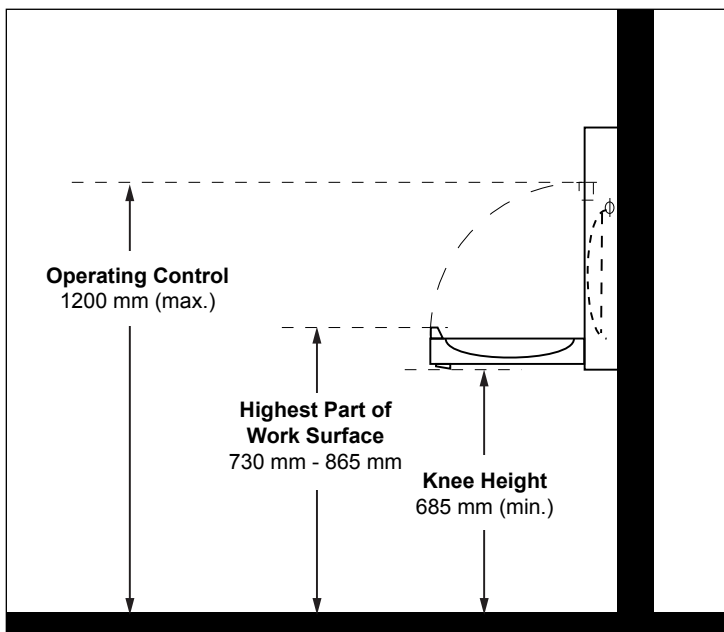

Figure 60a: Folding Baby Changing Station - Section View



Example of a Baby Changing Station.

Best Practice

Public facilities such as community and recreation centres, should provide an adult-size change table in each universal washroom.

Note

Adult-size change tables located in universal washrooms are of benefit to many individuals, and may be used as changing stations or tables. They allow persons with balance or strength problems to sit and allow persons with disabilities to lie down and be changed with the assistance of an attendant, as might be required.

Adult-size change tables are also useful in change rooms, where people are expected to change clothing.

4.5.9.2.2 Adult-Size Change Tables

Where an adult-size change table is installed in a universal washroom:

- provide a clear floor space of 760 mm wide by 1500 mm long (minimum), parallel to the long side of the table;
- when fully loaded, ensure the surface height above the floor is adjustable from between 450 mm and 500 mm at the low range to between 850 mm and 900 mm at the high range (**Figure 60b**);
- where a fold-down change table is provided:
 - install so that it does not encroach into the clear transfer space adjacent to the water closet;
 - ensure operating mechanisms (e.g., latches, handles and pulls) are 1200 mm high (maximum); and
 - ensure operating mechanisms are operable with a closed fist and without tight grasping, pinching of fingers or twisting of wrist;
- ensure changing tables can support a minimum load of 1.33 Kilonewtons;
- provide a high tonal contrast between change table surface and adjacent mounting surface; and
- ensure change table surfaces are free of sharp edges or abrasive materials, and are easy to clean.

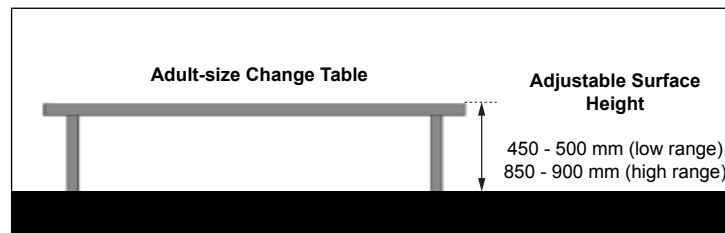

Figure 60b: Adult-Size Change Table

4.5.10 Urinals

Where more than one urinal is provided in men's multiple occupancy washrooms, provide at least one accessible urinal:

- locate within accessible path of travel with no step in front of the urinal;
- mount urinal on wall with the lower rim located 430 mm (maximum) above floor, OR provide a floor mounted urinal with the rim level with the floor level (**Figure 61a**);
- ensure the upper rim is no lower than 860 mm high above floor;
- ensure depth of 345 mm (minimum), measured from the outer face of the urinal rim to the back of the fixture (**Figure 61a**);
- ensure urinal has high tonal contrast compared with back wall;

- f. provide lever, automatic, or other flush control operable with a closed fist, without tight grasping, pinching or twisting of the wrist (e.g., push button control) mounted 1200 mm (maximum) high above floor (**Figure 61a**);
- g. provide clear floor space of 915 mm wide by 1370 mm deep (minimum) centered in front of urinal for front approach;
- h. provide grab bars, on each side of urinal (**Figure 61b**):
 - i. mount vertically, with centreline at 1000 mm high above floor;
 - ii. mount 380 mm to 450 mm from centreline of urinal;
 - iii. with length of 600 mm (minimum); and
 - iv. with high tonal contrast compared to back wall;
- i. install centreline indicator for all urinals (**Figure 61b**):
 - i. centred above the urinal 50 mm wide (maximum);
 - ii. extending 1300 mm (minimum) above floor but never less than 150 mm above the upper urinal rim;
 - iii. ensure indicator has high tonal contrast compared with back wall and raised 3 mm (minimum); and
 - iv. where more than one urinal is provided in a washroom, provide a centreline indicator at each urinal;
- j. where privacy screens are provided (**Figure 61b**):
 - i. provide clearance of 920 mm (minimum) between screens;
 - ii. ensure a clearance of 50 mm (minimum) from the grab bars;
 - iii. ensure colour contrast between screens and surrounding surfaces; and
 - iv. ensure the vertical outer edge provides a high tonal contrast.

Note

Placement of privacy screens is dependent on where grab bars are installed.

Vertical markers are used to identify centreline of urinal for users with vision loss.

Various elements may be used as a centreline indicator, such as exposed piping, architectural features (e.g., raised ceramic tiles), etc.

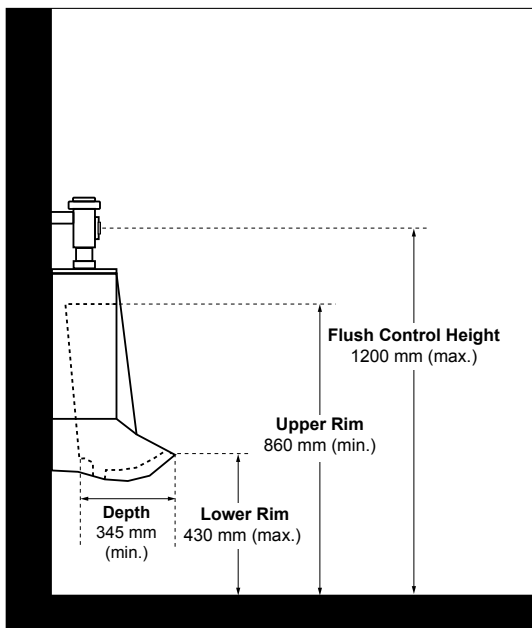

Figure 61a: Urinals - Side Elevation View

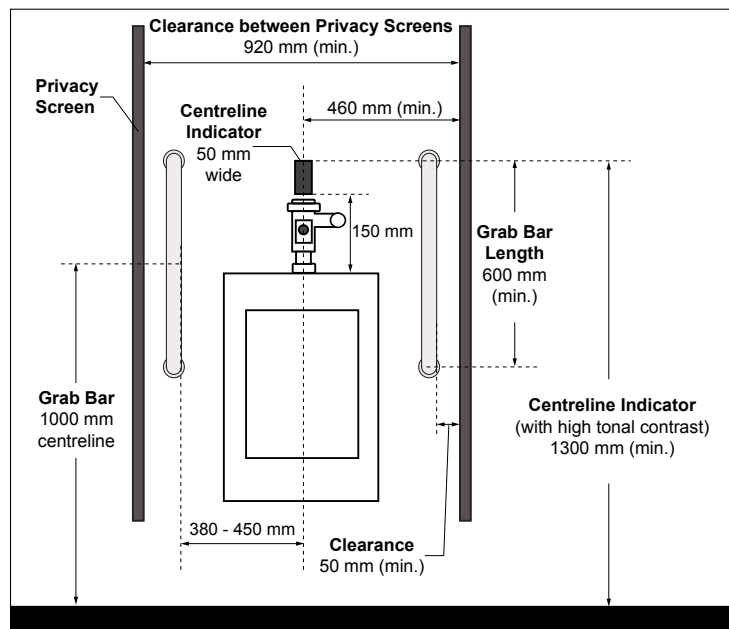

Figure 61b: Urinals - Front Elevation View



Showers

4.6

Application

This section applies to showers provided in all facilities.

Reference

Sec. 5.1 Controls and Operating Mechanisms

Sec. 5.7 Lighting

4.6.1 Provision

- a. provide at least one accessible shower stall where a group of showers are provided in a facility, as identified in **Table 9** below:

Table 9: Minimum Number of Accessible Showers

Number of Showers provided in a Group	Minimum number of Accessible Showers required
1-7	1
Over 7	1, plus 1 for each additional increment of 7 showers in a group

4.6.2 Design and Layout

- a. ensure floor space of 1500 mm wide by 900 mm deep (minimum);
- b. provide additional clear floor space of 1500 mm wide by 900 mm deep (minimum) at shower entrance (**Figure 62**);
- c. provide covered trench drain that is suitably located, based on the overall design of the stall and drainage requirements (e.g., preference is for water to drain away from user as much as possible);
- d. ensure level entry or beveled threshold, 13 mm high (maximum);
- e. ensure floor surface is slip-resistant; and
- f. provide lighting in accordance with Section 5.7 Lighting requirements, as applicable.

Best Practice

Where additional space is available, provide an accessible drying area, adjacent to the shower area with bench and grab bars (**Figure 63**).

Note

Where enclosure screens or curtains are provided, ensure mounting provisions do not obstruct transfer from mobility aids to shower seat.

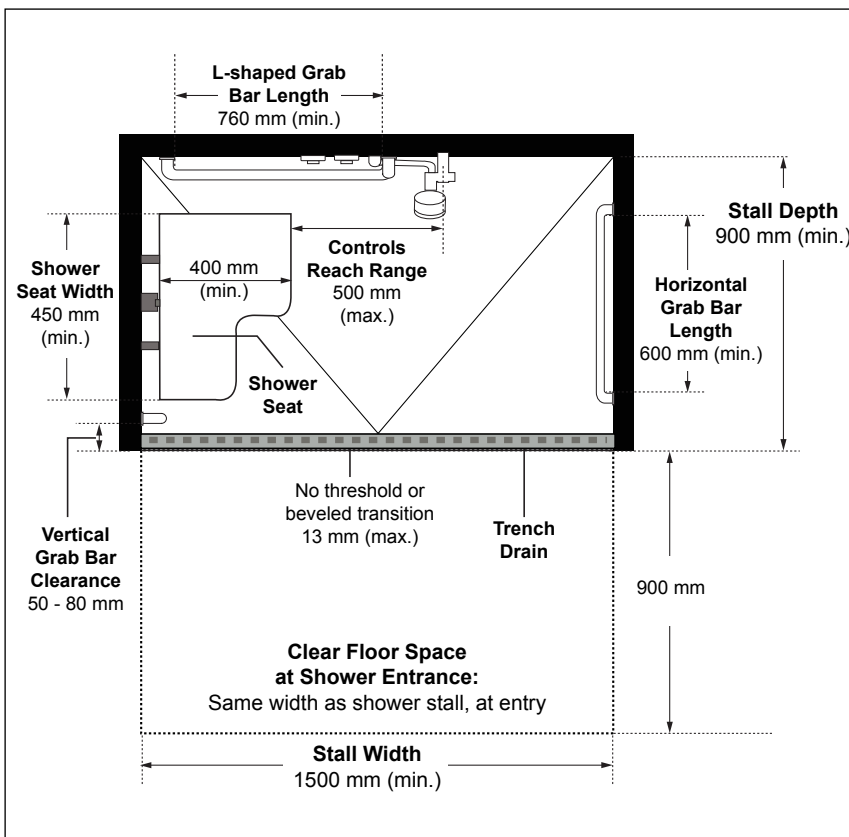

Figure 62: Shower Design and Layout - Plan View

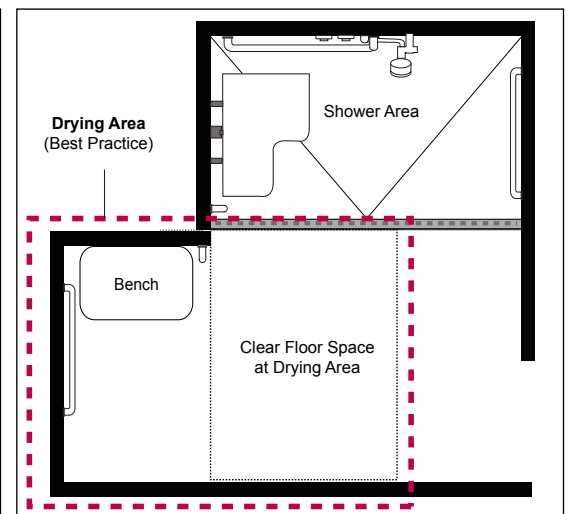
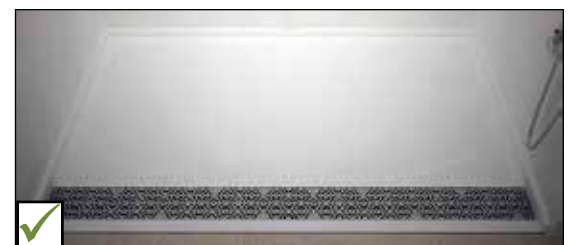

Figure 63: Drying Area - Plan View (Best Practice)



Trench drain at shower entrance.

Best Practice

Water-resistant and padded seat surfaces are recommended.

4.6.3 Controls and Accessories

4.6.3.1 General

- a. provide lever type or automatic controls that can be operated with a closed fist, mounted at 1000 high above floor;
- b. ensure all shower controls, including shower head, are located no more than 500 mm from the edge of the seat (**Figure 62**);
- c. provide a pressure equalizing or thermostatic mixing valve to control water pressure and avoid scalding, mounted at 1000 mm (maximum) high above floor; and
- d. provide fully recessed soap holders, mounted above grab bars between 900 mm and 1200 mm, reachable from a seated position.

4.6.3.2 Shower Head

- a. provide hand-held shower head with flexible hose 1800 mm (minimum) length;
- b. provide vertical support to mount shower head to allow operation as a fixed shower head,
- c. ensure the vertical support allows shower head to be adjustable to 1200 mm (maximum) height above floor and reachable from seated position; and
- d. ensure the vertical support placement does not obstruct the use of grab bars. (**Figure 64**).

4.6.3.3 Shower Seat

- a. provide a fixed shower seat or where a hinged seat is provided, ensure it is not spring-loaded;
- b. mount shower seat on the side wall adjacent to the controls;
- c. mount between 430 mm and 485 mm high above floor, with the front edge of the seat located within 500 mm of shower head and controls (**Figure 64**);
- d. provide surface 450 mm wide by 400 mm deep (minimum) with rear edge 65 mm from wall (**Figure 62**); and
- e. mount securely, capable of holding a minimum load of 1.3 kN.

4.6.4 Grab Bars

- a. ensure grasping surface is non-abrasive, slip-resistant and provide a high tonal contrast compared with mounting surface;
- b. provide circular profile, with diameter between 35 mm and 40 mm;
- c. ensure clear space of 50 mm (minimum) between mounting surface and grab bar, as well as between ends of grab bars and any adjacent wall; and
- d. mount securely to withstand a force of 1.3 kN applied in all directions.

4.6.4.1 Vertical Grab Bar

- mount on the side wall adjacent to shower seat;
- ensure length of 900 mm (minimum);
- mount with bottom edge between 600 mm and 650 mm high above floor to provide additional support when entering / exiting or when transferring to the seat; and
- provide a clearance between 50 mm and 80 mm from the adjacent clear floor space (**Figure 62**).

4.6.4.2 L-Shaped Grab Bar

- mount on wall opposite to shower entrance between the shower head and shower controls;
- ensure length of horizontal and vertical components is 760 mm (minimum) (**Figure 62**); and
- mount with horizontal component at 850 mm high above floor.

4.6.4.3 Horizontal Grab Bar

- mount on the site wall opposite from shower seat;
- ensure length of 600 mm (minimum) (**Figure 64**); and
- mount at 850 mm high above floor.

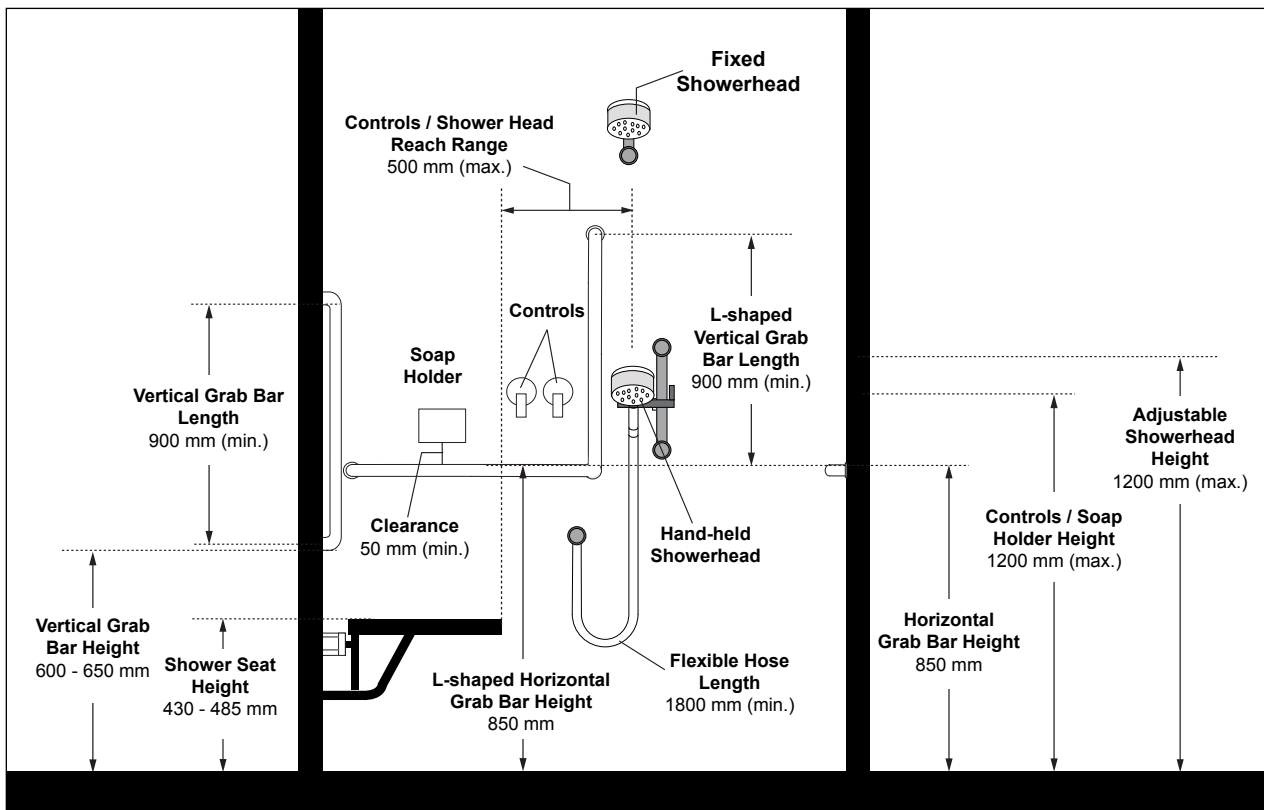

Figure 64: Shower Design - Section View

[Page intentionally left blank for printing purposes.]

Systems, Controls and Communications

5.0

Table of Contents

5.1	Controls and Operating Mechanisms	125
5.2	Assistive Listening Systems	128
5.3	Public Address Systems	130
5.4	Acoustics.....	132
5.5	Security Systems.....	134
5.6	Fire and Life Safety Systems	136
5.7	Lighting	140
5.8	Signage and Wayfinding	143
5.9	Windows.....	149

[Page intentionally left blank for printing purposes.]



Controls and Operating Mechanisms

5.1

Application

This section applies to typical interior and exterior controls and operating mechanisms provided for public and staff use, throughout accessible routes and spaces.

Examples of typical controls and operating mechanisms related to interior and exterior environments include, but are not limited to:

- entrance call buttons or intercoms;
- emergency call systems related to parking areas;
- light switches;
- wall outlets / duplexes;
- fire or other alarm system controls (e.g., washroom emergency alarms);
- thermostats;
- door hardware; and
- plumbing fixture hardware (e.g., faucets and water closet flush controls).

Controls related to product and dispensing machines, such as food and beverage vending equipment, payment stations for parking and ticketing devices, touch screen devices for information and self-service kiosks and other activation devices are also required to be accessible.

Best Practice

Multiple forms of audible, visual and tactile cues to indicate operating controls, benefits the widest range of users with varying disabilities (e.g., sensory / visual / cognitive).

Depending on the type of control, Braille can also be provided.

Align controls at the same height, where possible.

5.1.1 Design Features

Ensure accessible controls and operating mechanisms address the following:

- are usable with closed fist and operable with one hand;
- do not require tight grasping, pinching of the fingers, or twisting of the wrist;
- can be used with force of 22 Newtons (maximum);
- where push-button type controls are provided, button surface has a minimum diameter of 13 mm and is not recessed;
- ensure controls are visible from a distance, based on use of high tonal contrast between operable parts and adjacent mounting surface (**Figure 65**);
- mount controls and operating mechanisms (**Figure 66**):
 - no lower than 400 mm high for all controls;
 - at 1200 mm high for thermostat and manual fire alarm pull;
 - between 900 and 1100 mm high for all other controls and operating mechanisms;
 - so that they extend not more than 200 mm and not less than 900 mm high above the floor for vertical extended power door operators; and
- locate in prominent and obvious locations, for easy identification.

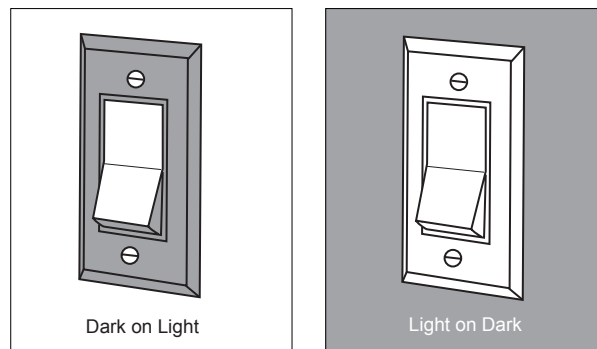

Figure 65: Tonal Contrast Between Background and Control

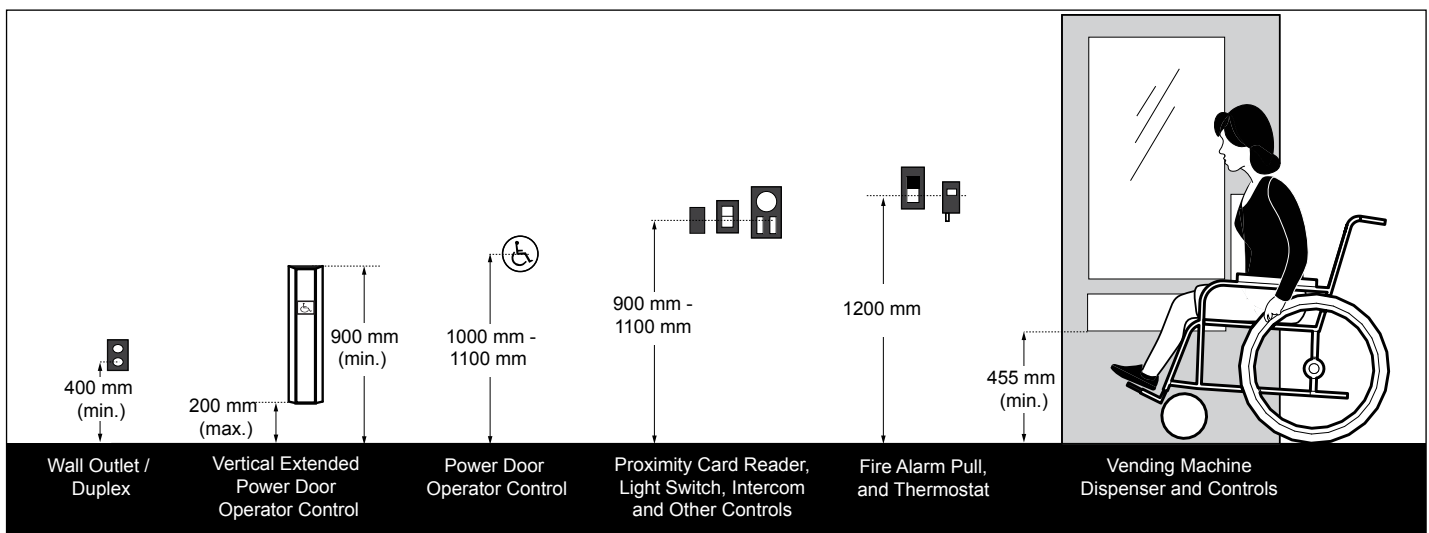

Figure 66: Control Mounting Heights - Elevation View

Best Practice

Provide clear floor space or ground surface with turning diameter of 1675 mm, to allow both side and frontal approach for larger wheeled mobility aids such as powered scooters and wheelchairs.

Note

The clear floor space in front of controls and operating mechanisms may overlap the adjacent interior accessible route.

5.1.2 Floor Space and Reach Requirements

5.1.2.1 Floor Space Requirements

- a. provide a clear floor space at controls and operating mechanisms of:
 - i. 915 mm wide by 1370 mm depth for a forward approach; and
 - ii. 1525 mm wide by 915 mm depth for a side approach.

5.1.2.2 Reach Requirements:

For both a forward and side approach, ensure the following mounting heights of controls and operating mechanisms for suitable reach are provided:

- a. where there is no obstruction in front of controls and operating mechanisms:
 - i. no lower than 400 mm;
 - ii. at 1200 mm for thermostat and fire alarm pull controls; and
 - iii. no higher than 1100 mm for other controls and operating mechanisms; and
- b. where there is an obstruction of no more than 860 mm high:
 - i. no higher than 1100 mm, which allows for a touch reach over a 600 mm deep obstruction or a grasp reach over a 500 mm deep obstruction (Figure 67a and b).

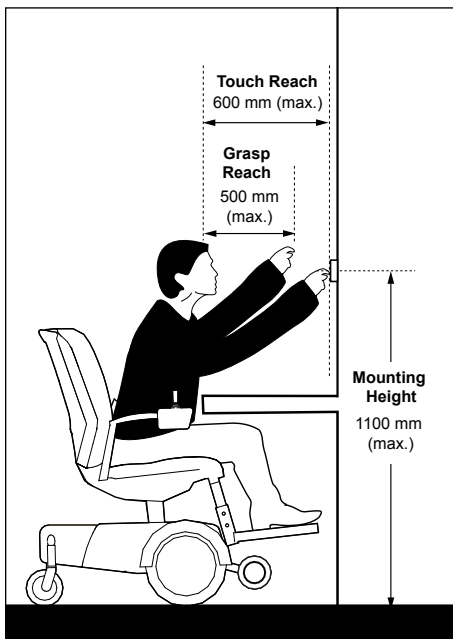

Figure 67a: Maximum Mounting Height for an Obstructed Forward Approach and Reach

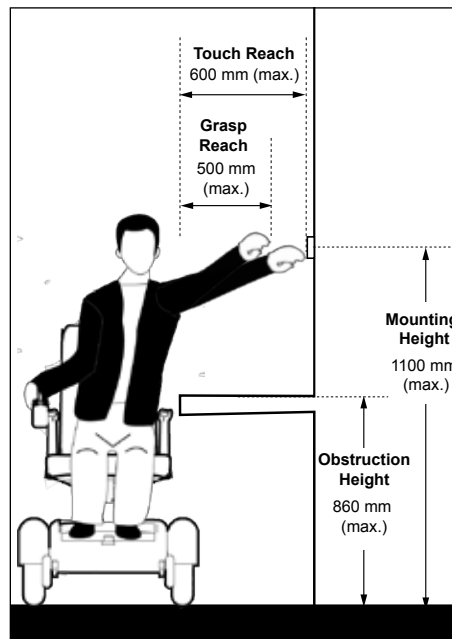

Figure 67b: Maximum Mounting Height over an Obstruction of 860 mm (maximum) for Side Approach and Reach

Assistive Listening Systems

5.2

Application

This section applies to assistive listening systems, required in assembly areas, including but not limited to classrooms, auditoria, meeting rooms and theatres:

- with an area of 100 square metres or occupancy of seventy-five (75) or more fixed seats;
- where audible communication is integral to the use of the space; and
- where audio amplification devices are used.

Induction loops, infrared systems and FM radio frequency systems are considered acceptable types of assistive listening systems for persons with hearing loss.

Wireless sound transmission systems, such as FM, infrared or magnetic induction loop, improve sound reception for the hard of hearing by providing amplification which can be adjusted by each user while blocking out unwanted background noise. These systems transmit a signal that is picked by special receivers available for use by people with a hearing disability, whether or not they use a hearing aid.

The transmitter can be jacked into an existing P.A. system amplifier or used independently with microphones. The induction loop system requires users to sit in the area circumscribed by the loop; though installation of the loop is relatively simple, the installer should be knowledgeable about these systems if proper functioning is to be achieved. FM or infrared systems can be designed to broadcast signals which cover the entire room and, thus do not restrict seating to any one area. Although portable systems (FM in particular) are available, these are best suited to small audiences. Generally, the systems installed in church halls, auditoria, theatres and similar places of assembly are not easily portable, as they are installed in a fixed location by a sound technician and form an integral part of the P.A. system of the room or building.

Reference

- Sec. 5.8 Signage and Wayfinding
- Sec. 6.1 Assembly Areas

Note

Some facilities such as courtrooms may have unique requirements and specifications, and require a detailed review prior to implementation.

Hard wired systems (where a jack is provided at a particular seat) will not meet the requirement in this section unless adequate provisions are made to accommodate persons with hearing aids. In choosing the most appropriate system, a number of factors must be taken into account including cost, installation and maintenance, suitability to the audience, ease of operation and the need for privacy. Information on designers and suppliers of these systems may be obtained from such organizations as the Canadian Hearing Society.

5.2.1 Design Features

For assistive listening systems, whether permanent or portable, ensure:

- a. system usability encompasses the entire floor area;
- b. system provides personal amplification control;
- c. system performs with or without the use of hearing aids; and
- d. signage is provided with the International Symbol For Hearing Loss pictogram to identify the availability of the assistive listening system and it is also marked with a 'T', where T-coil usage is available.

5.2.2 Assistive Listening Systems

5.2.2.1 Permanent Assistive Listening Systems

Where permanent systems are provided:

- a. the minimum number of required receivers is equal to 4% of the total number of seats, but never less than two; and
- b. the minimum number of required receivers to be hearing aid compatible is 25% of the total number of receivers that are provided, but never less than one.

5.2.2.2 Portable Assistive Listening Systems

- a. provide at least one portable assistive listening system, with a minimum of two receivers included for facilities with assembly spaces on multiple floor levels (e.g., this provides enhanced flexibility for the systems to be available and used at different locations); and
- b. ensure portable assistive listening systems include hearing aid compatibility.

Note

Where infrared assistive listening systems are used, ensure that no overhead incandescent lights cancel out the infrared signal at the receiver.

Receiver Hearing Aid Compatibility:

Receivers should be hearing-aid compatible and should interface with telecoils in hearing aids through the provision of neck loops.

Public Address Systems

5.3

Application

This section applies to public address systems installed within a facility as well as exterior, that provide information to the public and staff.

Reference

- Sec. 2.5 Overhanging and Protruding Objects
- Sec. 5.4 Acoustics

Note

This section applies only to facilities where public address systems are provided to convey information to the public or staff, as required for exterior / interior areas.

5.3.1 Design Features

- a. ensure sound level is above ambient background noise without distortion or feedback;
- b. consider zoning public address systems so that information can be directed to key locations only, to minimize background noise in other areas of the building; and
- c. mount speakers without projecting into or obstructing accessible routes and above head-level to provide effective sound coverage in required areas such as:
 - i. corridors;
 - ii. assembly and meeting rooms;
 - iii. recreational facilities;
 - iv. entertainment and educational facilities; and
 - v. common use areas located in institutional settings.

Note

To prevent confusion, ensure paging systems for use by staff or other key personnel are discreet and low in volume, sounding at devices or locations where staff are expected to be located.

Acoustics

5.4

Application

This section applies to the acoustic environment within a facility, which can either enhance or hinder a user's experience. Auditory cues along circulation routes in large open spaces and dedicated areas can serve as wayfinding cues, especially for people with vision loss.

Reference

Sec. 5.3 Public Address Systems

5.4.1 Design Features

To achieve a suitable acoustical environment, which can provide an additional wayfinding cues for persons with vision and / or hearing loss:

- a. integrate the use of sound-reflective or sound absorbent materials to differentiate essential sounds from general background sounds;
- b. select floor, wall and ceiling finishes to ensure that occasional noise is not unintentionally amplified (e.g., avoid hard floor surfaces such as marble and terrazzo);
- c. design ceiling shapes so that echoes do not occur;
- d. minimize all background noise (e.g., fans, mechanical systems, air conditioners and diffusers) in meeting rooms and assembly areas where spoken word is key to understanding proceedings;
- e. integrate and include adequate sound insulation in room and space design; and
- f. install a permanent inductive loop or similar assistive listening system for high use buildings and areas, especially where the surrounding environment may be noisy.

Note

Hard floor surfaces allow footsteps to be heard by persons with a vision loss, but too much additional noise may add confusion for persons with a hearing loss.

In general, domed shaped ceilings may distort sound.



Security Systems

5.5

Application

This section applies to typical security systems (e.g., proximity card readers, alarm systems), which are used to provide and limit access to areas of a facility.

Reference

- Sec. 4.2 Doors and Doorways
- Sec. 5.1 Controls and Operating Mechanisms

Note

Designers are to coordinate with Corporate Security to ensure the requirements of this section are met.

5.5.1 Design Features

Where users control independent entry or exiting to secured areas of facilities:

- locate controls between 900 mm to 1100 mm from the floor;
- mount controls at least 600 mm clear of the arc of any door swing (**Figure 68**);
- where electronic keypads or push button systems are provided, ensure buttons are raised from surface, mounted on surface with high tonal contrast and have raised numerals or letters to assist users with vision loss;
- ensure both audible and visual indicators are provided to alert users when access has been granted or denied;
- where proximity card readers (e.g., swipe cards) are used at doors equipped with power door operators, ensure activation of both systems is synchronized; and
- provide high tonal contrast on system controls, compared to mounting surface.

Best Practice

Proximity card reader systems are preferred at secured entry / exit areas to accommodate diverse users.

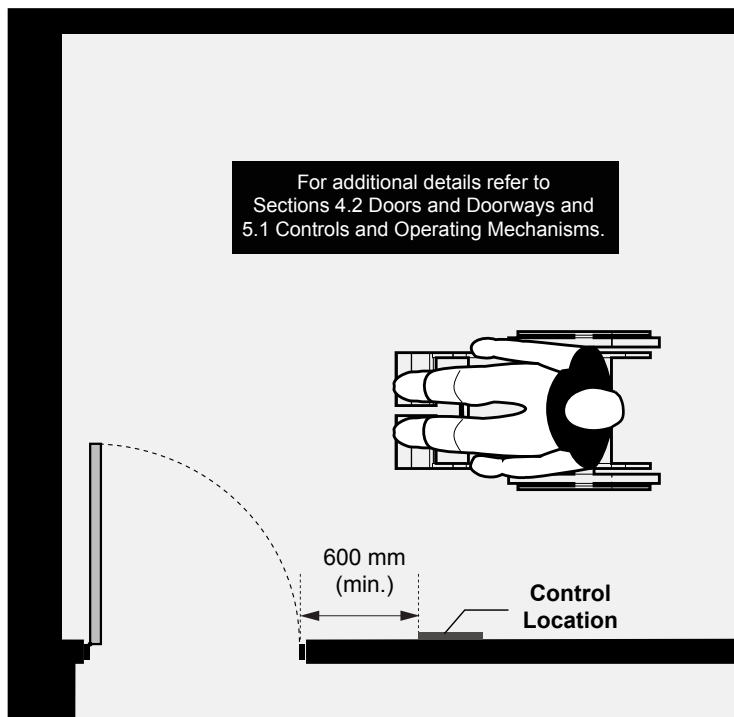



Figure 68: Proximity Card Reader Location - Plan View



Example of proximity card reader system that is large in size with high tonal contrast compared to mounting surface for enhanced visibility.



Example of proximity card reader system with visual indicator.



Fire and Life Safety Systems

5.6

Application

This section applies to fire and life safety systems, addressing the needs of people with varying disabilities, in emergency situations. Key components of typical fire and life safety systems include, but are not limited to:

- evacuation plans;
- alarm signals (both audible and visual);
- ‘Areas of Refuge’; and
- emergency exits.

Reference

- Sec. 4.2 Doors and Doorways
- Sec. 5.1 Controls and Operating Mechanisms
- Sec. 5.8 Signage and Wayfinding

Best Practice

Fire and life safety systems are especially important in facilities providing specialized services or programs to seniors and persons with disabilities. Seniors and people with disabilities are groups at greater risk and may require additional assistance or accommodation to evacuate a facility.

Note

The information in this section is provided as an additional resource to support other code and fire / life safety requirements that may be mandatory.

5.6.1 Fire Safety and Evacuation Plans

- a. provide a fire and life safety evacuation plan that addresses the needs of users with varying disabilities;
 - i. for facilities with floors above or below grade, develop a fire safety and evacuation plan, indicating in detail the preferred evacuation strategies for persons with disabilities (e.g., “Buddy System” where staff can help co-workers with disabilities evacuate);
 - ii. ensure the base of evacuation plans are posted no higher than 1200 mm from the floor (**Figure 69**);
 - iii. ensure evacuation plans incorporate a font size of 14 point (minimum);
 - iv. ensure evacuation plans are available in alternate formats; and
 - v. provide signage to identify evacuation plans;
- b. mount controls and operating mechanisms:
 - i. between 900 mm and 1100 mm from floor for emergency and life safety controls and operating mechanisms such as fire extinguishers, first aid kits and defibrillators; and
 - ii. at 1200 mm high from floor for manual fire alarm pull.

Best Practice

Where appropriate, consider installation of a fire fighter’s elevator that can be operated by fire department personnel during emergencies.

Consider providing photoluminescent signage (i.e., visible in dark or smoke-filled environments), in addition to regulatory exit signage, throughout exit stairs and at strategic locations along exit routes to assist with evacuation. Additional review may be required to coordinate with Building and Fire Code requirements.

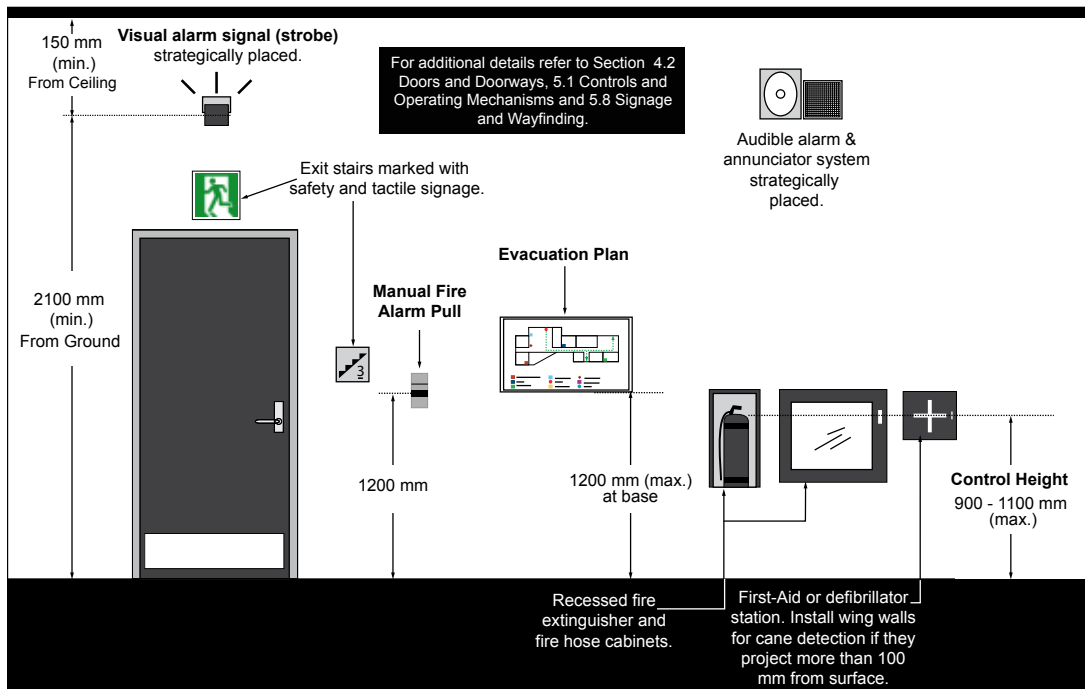

Figure 69: Fire Safety and Evacuation Features - Elevation View

Best Practice

For existing facilities where fire alarm systems cannot be upgraded, consider the provision of portable, vibrating pager systems for users with vision and hearing loss.

For public facilities, install visual alarm signals in common use areas including, central lobbies, corridors, main assembly areas (e.g., auditoriums, conference rooms and cafeterias) and places where a person may be alone (e.g., universal washrooms).

To reduce the likelihood of triggering an epileptic seizure or other photosensitive reaction from multiple unsynchronized visual strobe lights, ensure the flash rate is less than 2 Hertz.

Note

Optimal visual alarm signal placement requires formal study for unique environments, including multi-purpose facilities, libraries, convention / meeting rooms and other facility types to ensure signals are visible from all required areas.

5.6.2 Visual Alarm Signals

Where visual alarm signals are provided for users with hearing loss:

- integrate visual alarm signals with required audible fire alarm system, including during retrofit projects where feasible;
- mount appliance at 2100 mm (minimum) above the floor level within the space or 150 mm below the ceiling, whichever is lower (**Figure 69**);
- where visual alarm signals are provided in any common space, public corridor, hallway, lobby or room, ensure they are placed no more than 15 metres apart, on the horizontal plane;
- install visual alarm signals so that the signal from at least one device is visible throughout the floor area or portion of it in which they are installed; and
- ensure light and flashing features are based on the following criteria:
 - use a xenon strobe type or equivalent for light or lamp fixture;
 - ensure clear or nominal white colour (e.g., unfiltered or clear filtered white light);
 - provide maximum pulse duration of 0.2 seconds, with a maximum duty cycle of 40 percent;
 - ensure the intensity of the visual alarm signal raises the overall light level sharply, but not so intense as to be unsafe for direct viewing;
 - ensure a flash intensity of 75 candela (minimum) with a flash rate between 1 Hertz (minimum) and 3 Hertz (maximum); and
 - synchronize visual alarms that are located in the same proximity to flash at the same time.



Example of combined visual and audible alarm signals. Public facilities should have both visual and audible fire alarm systems strategically located.

5.6.3 Areas of Refuge

Where an 'Area of Refuge' is included as a component of a facility's fire safety and evacuation plan for persons with disabilities:

- a. locate on an accessible route, which is served by an exit or fire fighter's elevator;
- b. locate clear of any adjacent door swing and away from pedestrian exit route(s);
- c. ensure areas of refuge are easy to identify and are designated with signage (e.g., large print, tactile features stating 'Area of Refuge' and marked with the International Symbol of Accessibility);
- d. ensure a clear floor space of at least 1675 mm by 1675 mm is provided to accommodate users of mobility aids;
- e. provide protective enclosure for a minimum of one-hour;
- f. provide a two-way, accessible communication system supported by the facility's backup generator and linked to the designated fire control centre / panel;
- g. ensure communication system is marked with signage and includes both audible and visual notification devices to indicate "help is on the way"; and
- h. provide separate emergency lighting and ventilation systems supported by a backup generator.



'Areas of Refuge' should be designated with signage, including Braille and tactile features for users with vision loss.

Best Practice

Provide emergency electrical power to ensure adequate emergency lighting levels for the use of elevators and key operating components or other systems during a power outage. Provide in all major areas of the facility, along all paths of travel to exits and in all designated 'Areas of Refuge'.

Note

Stairwells and elevator lobbies are typically used for 'Areas of Refuge', if properly designed with all required features and floorspace to accommodate mobility aids. Detailed review and design is required for provisions in any type of facility, existing or new.

The provision of additional spaces for accommodating mobility aids in an 'Areas of Refuge' is determined by facility occupancy and level of use.



5.7

Application

This section addresses lighting requirements for both interior and exterior environments.



Note

For additional information on lighting requirements refer to the Illuminating Engineering Society's "The Lighting Handbook", latest version.

5.7.1 Lighting Level Requirements

For lighting level requirements for interior and exterior environments, designers must refer to the appropriate reference document for detailed requirements.

Reference documents include:

- a. City of Ottawa Right-of-Way Lighting Policy;
- b. City of Ottawa Park Pathway Lighting Policy;
- c. Ontario Building Code; and
- d. Illuminating Engineering Society of North America “The Lighting Handbook”.

5.7.2 Exterior Lighting - Good Design Practices

- a. ensure lighting sources are located at or beside all ramps, steps and stairs, to illuminate and identify surfaces, treads, risers, nosings and handrails;
- b. ensure all lighting over pedestrian routes is evenly distributed and provides a reasonable colour spectrum while minimizing any shadows casted;
- c. provide supplementary lighting to highlight all wayfinding signage, as required;
- d. ensure lighting fixtures or posts do not encroach on accessible routes / paths of travel;
- e. ensure low-level lighting standards are mounted high enough to clear normal snow accumulation heights; and
- f. ensure overhead light fixtures are mounted with clear headroom of 2100 mm (minimum).

5.7.3 Interior Lighting - Good Design Practices

- a. use natural light wherever possible to illuminate entrances, corridors and key workspaces; however, avoid designs that results in direct glare reflected from flooring or work surfaces;
- b. integrate sources of both artificial and natural lighting to provide comfortable, evenly distributed light at working surfaces and throughout circulation routes;
- c. ensure lighting design allows an illumination quality that is as close to a full spectrum as possible to aid in identifying edges and colour contrasts which are used as wayfinding cues (this ensures the warm end of the spectrum provides appropriate colour definition);
- d. ensure any leading edge of stairs, steps, ramps or escalators are evenly lit; and
- e. ensure sources of light (natural or artificial) are not positioned at the ends of corridors or behind people at reception areas or counters.

Best Practice

The Canadian National Institute for the Blind (CNIB) recommends increasing I.E.S.N.A suggested lighting levels by a range of 25 to 50 percent to address the needs of people with vision loss.

When entering buildings, eyes may require a few moments to adjust from a brighter exterior environment to a darker interior or vice versa. For people with vision loss, the adjustment time may be longer. Transitional lighting options (higher artificial lighting levels near the entrance in daylight and lower levels after dark) should be considered.

Note

Variations in lighting levels can be confusing to many older adults, people with cognitive disabilities and people with vision loss.

Best Practice

Avoid the use of light fixtures with multiple pinpoints of high intensity illumination. They may add an unnecessary source of glare and leave an after image on the retina of people with vision loss.

Do not use high gloss finishes at any times.

Note

Monolithic floor surfaces, such as stone, granite, marble or terrazzo in a matte or honed finish, minimize any potential for reflected glare.

High intensity light sources such as quartz, halogen or other pinpoint sources (e.g., chandeliers) can produce reflected points of glare on shiny surfaces.

5.7.4 Additional Considerations: Issues Related to Glare

- select lighting sources, materials and finishes that do not reflect glare, including implementing strategies to control natural lighting sources wherever possible;
- ensure floor surface finishes such as vinyl, terrazzo and ceramic tile, mosaics or other materials have a matte or satin finish;
- provide matte or satin wall finishes (e.g., paint, vinyl coverings, stone, marble, wood, plastic or laminate) to prevent and minimize glare;
- provide curtains, blinds, screens or other strategies to shield bright, natural lighting sources, especially where direct sunlight may cause glare;
- select light fixtures that prevent or minimize any potential for direct glare (e.g., with diffusers, lenses, or recessed light sources); and
- where surface mounted fluorescent ceiling lights are used (e.g., in corridors), it is generally recommended that they have darkened sides (e.g., wrap-around lenses are not recommended) and that they are positioned at right angles to the path of travel.



Example of floor surface and elevator door finishes that minimize glare.



Application

This section applies to signage and wayfinding strategies, where provided in exterior and interior environments.

Recognizing that signage programs and wayfinding strategies are customized based on facility types and use of space, the information and criteria in this section is provided as a starting point.

There are different types of signage for various purposes:

- regulatory signs, which include prohibition signs denoting an order forbidding an action, and mandatory signs which denote an order requiring an action;
- warning signs such as caution and danger signs denote a potential hazard and a definite hazard, respectively; and
- identification signs, which include rooms, titles, names or numbers are provided for general orientation or specific information, such as washrooms, routes of egress, stairwells, doorways or offices.

Best Practice

Avoid using vertical wording and electronic scrolling signage.

Where scrolling signage has to be used, ensure characters and symbols move slowly across the screen.

Keep information on signage short and simple.

Using a combination of lower case and upper case lettering is easier to read than using all upper case lettering. The “shape” of the text or message is more legible and creates its own image for familiarity.

Avoid very fine type and very thick type font.

Note

Consistent locations include height considerations for overhead or wall-mounted signs, as well as uniform placement of identification signs for facilities and services.

Nearsighted persons might have to approach much closer to read a sign than persons with average visual acuity. Signs at eye level allow persons to get closer to the sign.

5.8.1 Signage

5.8.1.1 Design Features

- ensure signage surfaces have matte, eggshell or non-glare finish;
- ensure signage is of uniform design;
- provide colour contrast between signage and mounting surfaces;
- where used to give the same type of information within the same facility, ensure signage is consistently shaped, coloured and positioned;
- where facilities or elements, including but not limited to washrooms, elevators, telephones, information kiosks, routes, ‘Areas of Refuge’, and parking facilities are accessible, provide signage with the International Symbol of Accessibility to designate as accessible (**Figure 70**); and
- provide lighting in accordance with Section 5.7 Lighting requirements, as applicable, at signs.

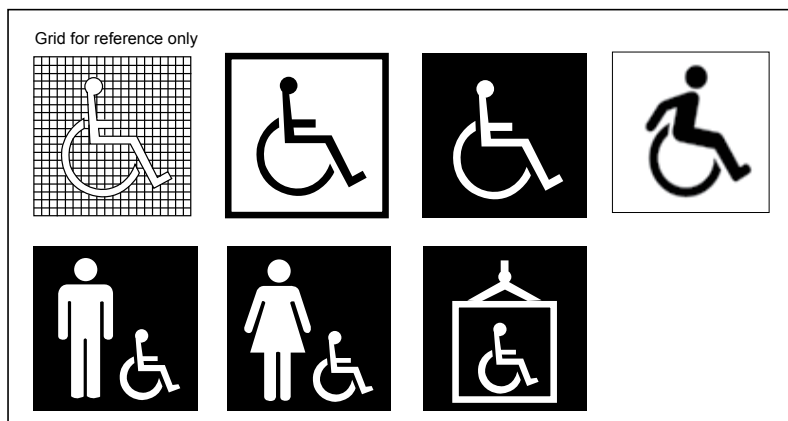

Figure 70: Examples of International Symbols of Accessibility

5.8.1.2 Character Features and Sizes

- ensure text characters (e.g., letter or number) are sans serif font type and have Arabic numerals;
- where text is provided, ensure it is bilingual;
- provide width to height ratio between 3:5 and 1:1 (**Figure 71**);
- provide stroke width to height ratio between 1:5 and 1:10;
- ensure characters are not italic, oblique, script, highly decorative or of other unusual forms;
- provide high tonal contrast between text characters and background surface;
- ensure the minimum character height is provided as per viewing distance as identified in **Table 10**; and
- use an uppercase “X” for character measurement.

Table 10: Character Height Relative to Viewing Distance

Minimum Character Height (mm)	Maximum Viewing Distance (mm)
200	6,000
150	4,600
100	2,500
75	2,300
50	1,500
25	750

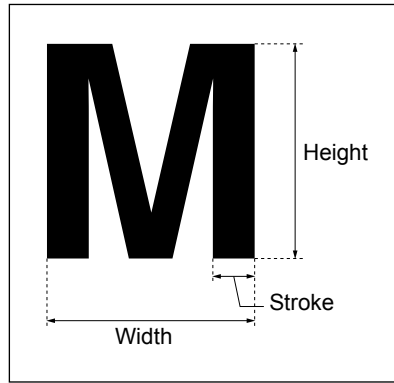

Figure 71: Character Features and Sizes

Note

Some factors affecting ease with which text can be distinguished from its background include shadows cast by lighting sources, surface glare, and the uniformity of the text and background colours and textures.

Where illuminated signage is provided, avoid using red, blue or green LEDs on a black background as they are unreadable for most people with vision loss.

For Ottawa specific pictograms, refer to Appendix 7.7 “Tactile Signage Standard Pictograms”.

5.8.1.3 Pictograms and Symbols

Pictograms and symbols are used to complement text information and identify important facility features, elements or services, including information desks, public washrooms, and elevators. Where pictograms are used:

- a. ensure pictogram has a field height of 150 mm (minimum);
- b. provide text descriptors and braille directly below the pictogram field and not in the pictogram field;
- c. provide high tonal contrast between pictogram the field;
- d. use the International Symbol of Accessibility to identify accessible facility features, spaces, elements and amenities (**Figure 70**); and
- e. use recognized and standardized symbols for accessibility features or other key building elements (e.g., washrooms, telephones and elevators) to facilitate wayfinding for all users (**Figure 72**).

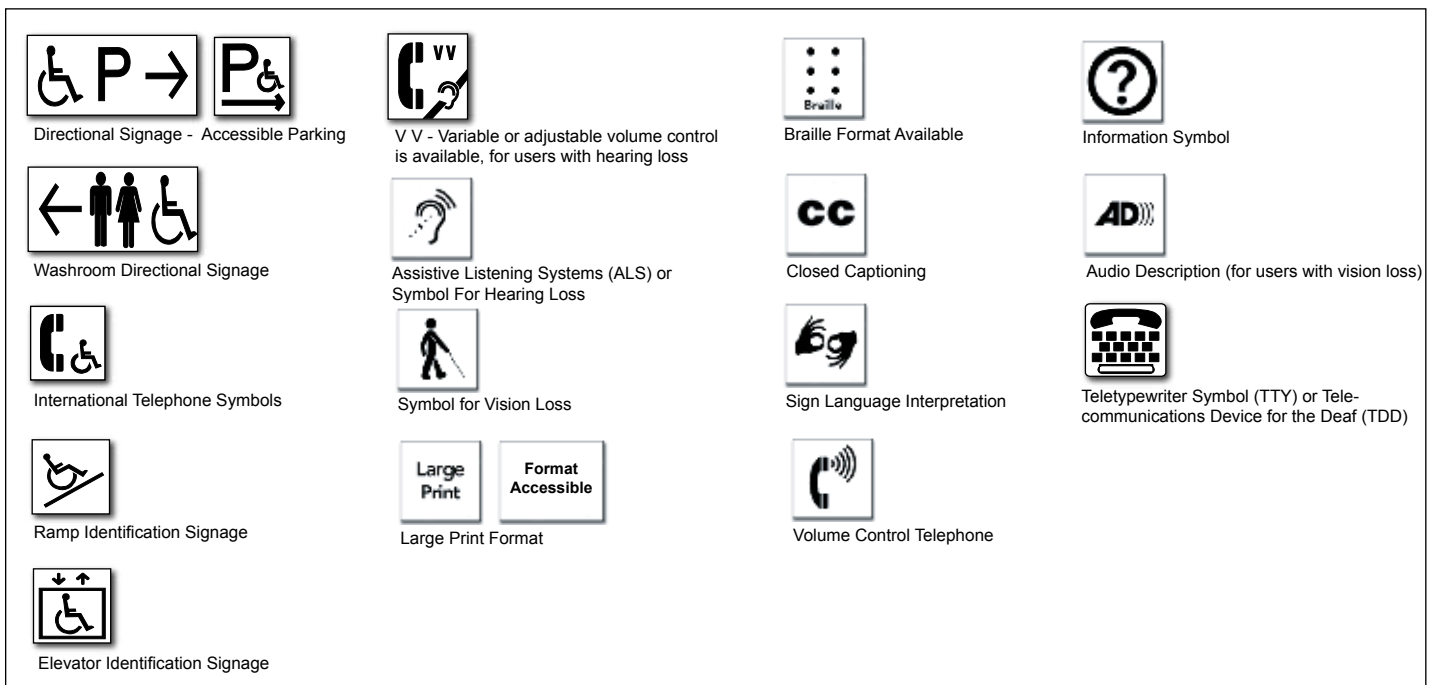

Figure 72: Example of Typical Pictograms and Symbols

Note

Braille or tactile features are only required for signs that can be reached and touched to identify permanent rooms and spaces. These features are not required for overhead or suspended signage (e.g., directional information).

Avoid mounting signage directly on external glazing where possible as it may reduce visibility and legibility of text.

5.8.1.4 Braille

Where braille is provided on signage:

- a. ensure it is uncontracted braille (Grade 1) bilingually;
- b. ensure braille dots have a domed or rounded shape;
- c. locate immediately below the corresponding text (e.g., room numbers, names) and / or pictogram; and
- d. where text is multi-lined, place braille below the entire text.

5.8.2 Tactile Signage

Signage with tactile features (e.g., braille, raised characters / text, symbols or pictograms) are designed to be read by touch.

5.8.2.1 Design Features

Where tactile characters are provided:

- a. ensure text characters (e.g., letter or number) and pictograms (where provided) are raised between 0.8 to 1.5 mm above the surface (**Figure 74**);
- b. ensure the edges of the text characters are gently rounded;
- c. provide high tonal contrast between the tactile characters and the background surface;
- d. ensure all raised text characters, pictograms or symbols are accompanied by equivalent description in bilingual braille;
- e. where pictogram is provided, ensure they are 150 mm (minimum) high; and
- f. for text characters (e.g. letter or number):
 - i. ensure they are sans serif font and Arabic numerals;
 - ii. ensure text is bilingual;
 - iii. ensure height of characters are between 16 and 50 mm; and
 - iv. ensure text is entirely in upper case lettering as it is easier to read by touch, compared to a combination of upper and lower case letters.

5.8.2.2 Mounting Locations

Where signage with tactile features is provided:

- a. mount at 1220 mm (minimum) high, measured from the baseline of the lowest tactile character and 1525 (maximum) high, measured from the baseline of the highest tactile character (**Figure 73**);
- b. where provided at a door, install consistently on the wall beside the latch edge of door, 150 mm +/- 10 mm from the door frame;
- c. where provided at double doors with one active leaf, mount signage to the right of the right hand door;

- d. where there is no wall space at the latch side of a single door or on the right side of the double door, install signage on nearest adjacent wall;
- e. install to allow users to approach within 100 mm of sign location, clear of any door swing or protruding objects;
- f. mount so that a clear floor space of 455 mm by 455 mm (minimum), centred on the tactile characters is provided beyond the arc of any door swing between the closed position and the 45 degree open position; and
- g. ensure a clear wall area of 75 mm wide (minimum) around the sign is provided.

Best Practice

In larger and complex buildings, such as recreation centres, provide tactile maps on each floor, close to the major point of arrival to the floor (e.g., elevator lobby) to assist with wayfinding for users with vision loss (**Figure 75**).

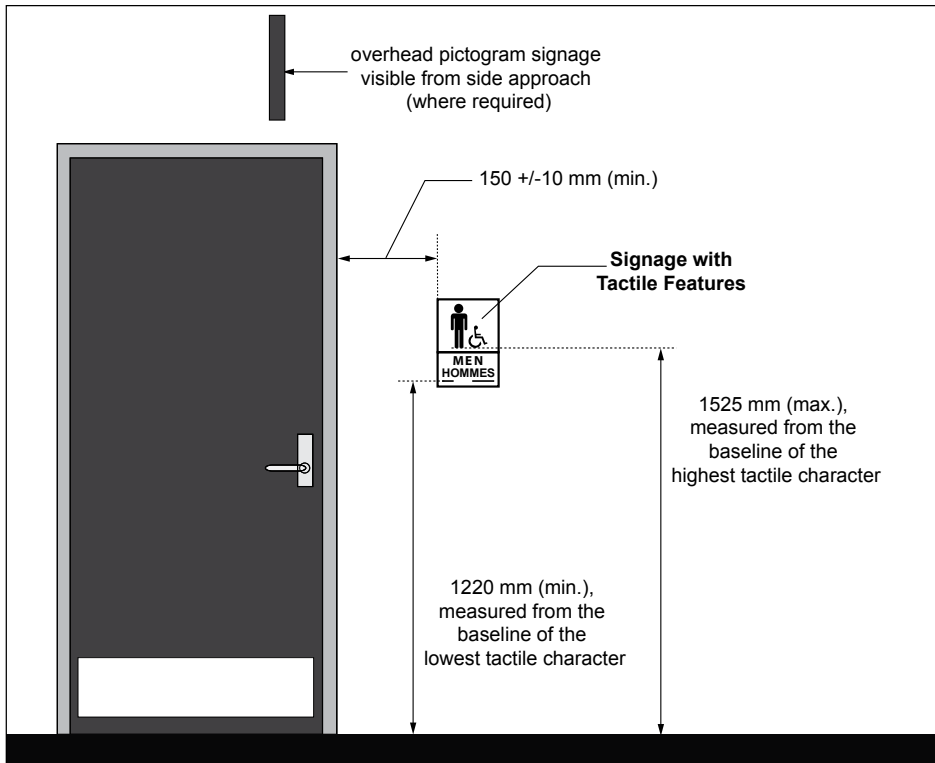

Figure 73: Mounting Location of Signage with Tactile Features - Elevation View



Example of accessible signage to identify accessible washroom.

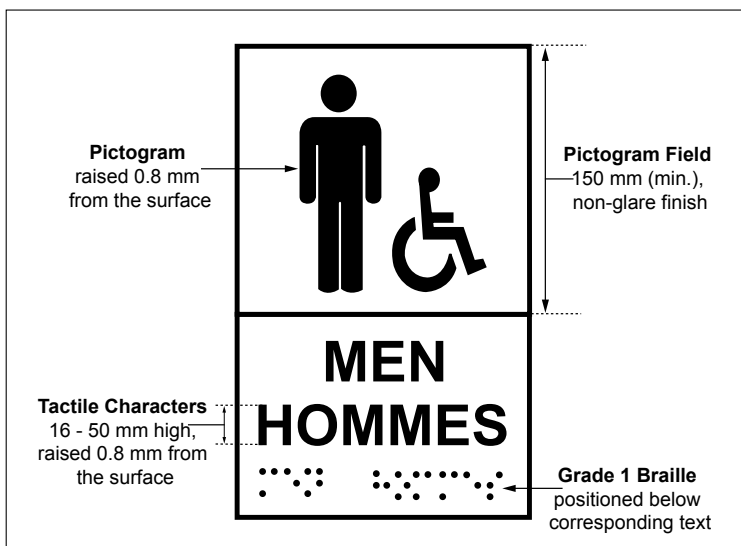

Figure 74: Signage with Tactile Features

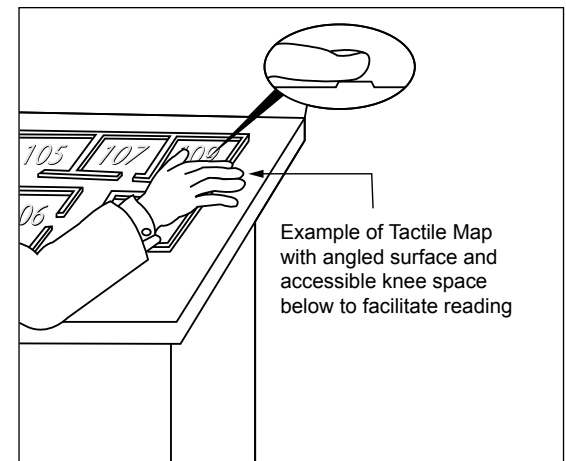

Figure 75: Tactile Map (Best Practice)

Best Practice

Control the use of temporary signage, which can render other relevant and accessible signage ineffective, through management procedures / protocols. Temporary signage typically uses improper language, materials and text sizes.

Mount signs so that they face the direction of travel as they are easiest to notice and read for people who might have limitation moving their head or have reduced peripheral vision.

5.8.3 Wayfinding Principles

- a. ensure consistent design, strategic placement and ideal mounting heights at key decision-making points along accessible routes for all signage;
- b. provide high tonal contrast between signage and mounting surfaces for full visibility;
- c. ensure there is no information overload or cluttering of signage to avoid confusion; and
- d. avoid placing suspended signs against a light source to ensure full visibility (e.g., at the end of corridors which have windows, glass doors or window walls).

Windows

5.9

Application

This section applies to windows, glazed screens, vision panels in doors, and fully glazed sidelights, intended for viewing or that are required for ventilation.

Reference

- Sec. 4.2 Doors and Doorways
- Sec. 5.1 Controls and Operating Mechanisms

Note

Accessibility requirements are applicable to windows that are intended for use by facility occupants, staff or public.

Best Practice

Floor space with turning diameter of 1675 mm is preferred to accommodate larger mobility aids.

Where there is extensive glazing, consider providing a strip at a lower level, between 850 to 1000 mm high above finished floor level.

5.9.1 Design Features

For windows, glazed screens and vision panels, designed for the purpose of viewing:

- a. provide clear floor space of 915 mm wide by 1370 mm deep (minimum) for forward and 1525 mm wide by 915 mm deep (minimum) for side approach by users of mobility aids;
- b. locate bottom sill height no more than 1100 mm above the finished floor;
- c. where ventilation controls are provided, mount between 400 mm and 1100 mm above the finished floor to be reachable from a seated position (**Figure 76**);
- d. do not locate horizontal structure (e.g., mullion or other visual obstruction) between 900 mm and 1300 mm above the floor; and
- e. where wall systems include extensive use of glazing, provide horizontal markings strips:
 - i. 50 mm in height, extending full width of glazed area, mounted between 1350 mm and 1500 mm above finished floor; and
 - ii. ensure high tonal contrast is provided for users with vision loss.

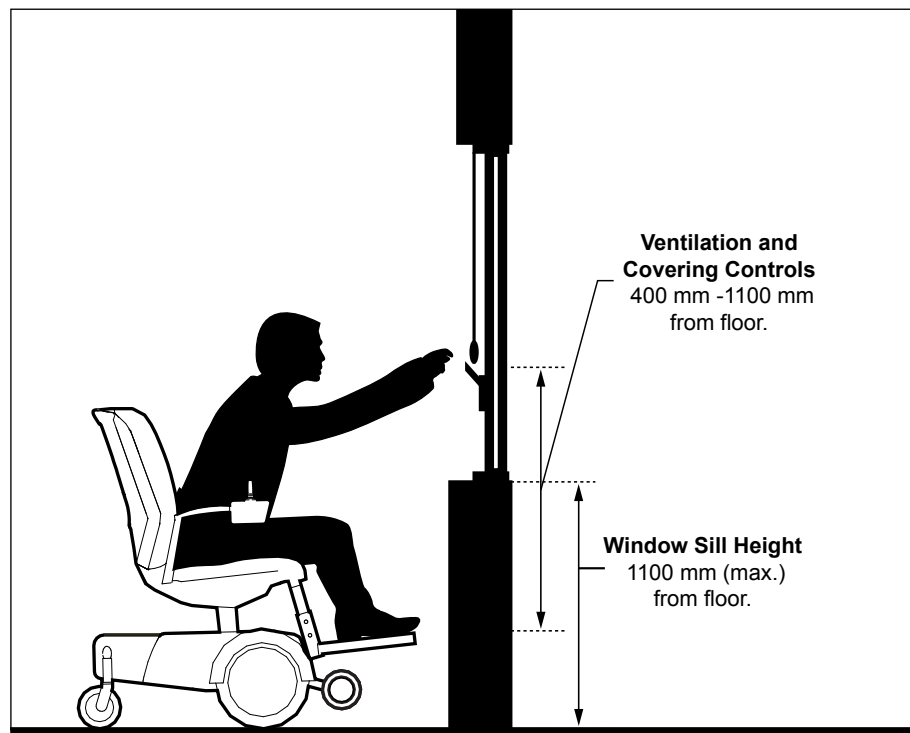

Figure 76: Window Design Features - Elevation View

Special Facilities and Spaces

6.0

Table of Contents

- 6.1 Assembly Areas153
- 6.2 Meeting and Multi-Purpose Rooms157
- 6.3 Cultural and Art Facilities.....159
- 6.4 Cafeteria and Dining Facilities161
- 6.5 Kitchens and Kitchenettes164
- 6.6 Libraries172
- 6.7 Recreational and Community Facilities176
- 6.8 Change Rooms.....180
- 6.9 Balconies and Terraces184
- 6.10 Service Counters.....186
- 6.11 Waiting and Queuing Areas.....189
- 6.12 Elevated Platforms or Stages192
- 6.13 Visitability - Housing.....194
- 6.14 Outdoor Public Use Eating Areas.....197
- 6.15 Recreational Trails, Beach Access Routes and Boardwalks...199
- 6.16 Recreational Trail Design Checklist206
- 6.17 Inclusive Play Spaces209
- 6.18 Inclusive Play Space Design Guide.....215
- 6.19 Inclusive Play Space Checklist.....219
- 6.20 Public Transit221
- 6.21 Office Environments (**Reserved**).....227

[Page intentionally left blank for printing purposes.]



6.1

Application

This section applies to assembly areas in both interior and exterior environments. Common assembly areas, where accessible seating spaces are required are identified in **Table 11**.

Table 11: Common Assembly Areas

Civic	Entertainment / Cultural	Educational	Sports
Council Chamber	Theatre	Lecture Hall	Arena
Public Meeting or Hearing Room	Places of Worship	Classroom	Stadium
Auditorium	Performing Arts Centre	Conference / Symposium Room	Gymnasia
Multi-purpose Room (e.g., Community or Recreation Centres)	Museum	Stage / Podium	Grandstand Stage

Reference

- Sec. 2.4 Guards and Handrails
- Sec. 5.1 Controls and Operating Mechanisms
- Sec. 5.2 Assistive Listening Systems
- Sec. 5.7 Lighting
- Sec. 5.8 Signage and Wayfinding
- Sec. 6.12 Elevated Platforms or Stages

Best Practice

In assembly areas, where lighting is dimmed (e.g., theatres or performing arts centre), ensure steps and accessible routes are illuminated (e.g., marked with lighting strips) to assist with identification.

Adaptable seating, with armrests that flip up and down at the end of aisle seats, provides assistance to persons transferring from mobility aids.

Note

Persons using mobility aids usually sit higher than persons in standard seating and accessible seating spaces should be located to ensure that when they are occupied, the views of others that may be seated behind them are not obstructed.

6.1.1 Design and Layout

- ensure lighting level is evenly distributed throughout all accessible routes and accessible seating spaces;
- ensure a consistent accessible path of travel of 1100 mm (minimum) throughout space for circulation;
- provide accessible seating options for users of mobility aids;
- provide assistive listening systems, designed for the type of venue and audience; and
- ensure all audio-visual equipment, features, controls and related technology are usable by all participants and staff, where provided, including the provision of instructions and guidance in alternative formats.

6.1.2 Accessible and Adaptable Seating

6.1.2.1 Provision

Where fixed seating is available in assembly occupancies:

- provide accessible seating spaces for users of mobility aids and adaptable seating based on total number of fixed seats, as identified in **Table 12**:

Table 12: Accessible and Adaptable Seating Requirements in Assembly Areas

Total Number of Fixed Seats	Minimum Number of Accessible Seats	Minimum Number of Adaptable Seating
Up to 20	2	1
21 to 40	2	2
41 to 60	2	3
61 to 80	2	4
81 to 100	3	5
Over 100	3% of seating capacity	the greater of 5 seats or 5% of the aisle seating capacity

6.1.2.2 Accessible Seating Spaces

- install directional signage in prominent locations to identify location of accessible seating spaces;
- locate spaces adjoining an accessible path of travel, without infringing on egress from any row of seating;
- provide at least one fixed companion seat adjacent to accessible seating spaces and within the same row, ensuring shoulder alignment for users sitting beside each other (**Figure 77**);
- when entering from side, ensure clear floor space at accessible seating spaces is 1525 mm wide by 915 mm deep (minimum) (**Figure 79**);
- when entering from rear or front, ensure clear floor space at accessible seating space is at least 915 mm wide by 1400 mm deep (minimum);

- f. ensure at least two accessible seating spaces are provided side by side;
- g. where accessible seating spaces are situated as part of the designated seating plan, provide a choice of viewing location and ensure there is a clear view of the event taking place (**Figure 79**);
- h. where accessible seating spaces are provided on an elevated platform (**Figure 78**), ensure the lines of sight are:
 - i. comparable to those for all viewing positions;
 - ii. not reduced or obstructed by standing members of the audience; and
 - iii. free of any obstructions (e.g., any barriers, handrails, guardrails or columns); and
- i. ensure accessible seating spaces are positioned so that they do not obstruct sight lines of other users either sitting or standing.

Best Practice

An increased riser height for accessible seating spaces ensures suitable sight lines and comparable views when users in front are in standing position.

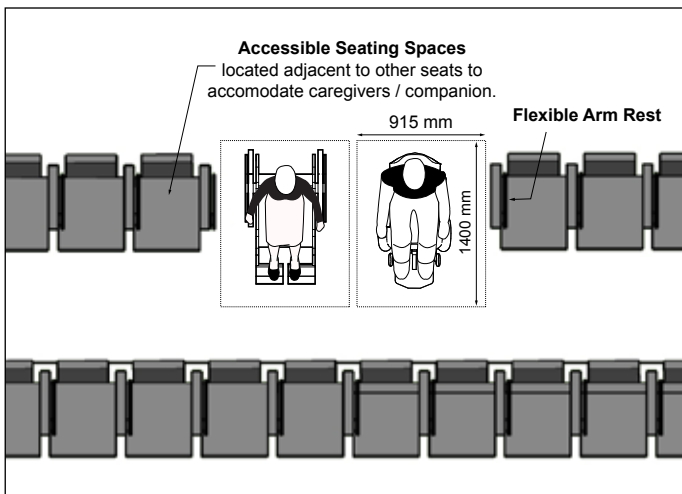

Figure 77: Accessible Seating Space Dimensions

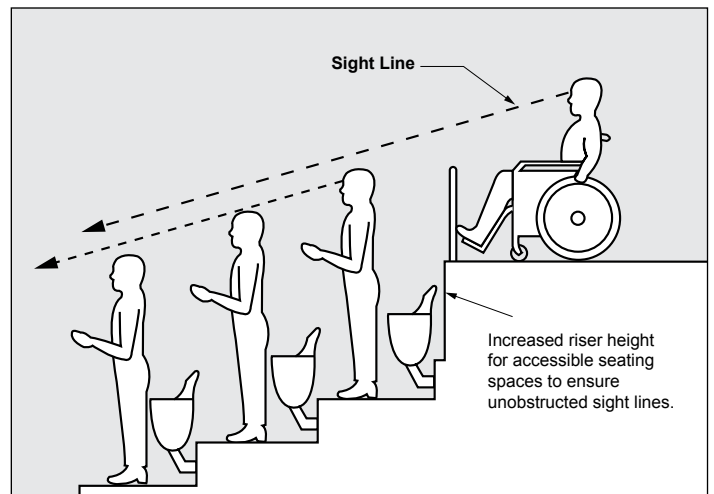

Figure 78: Lines of Sight

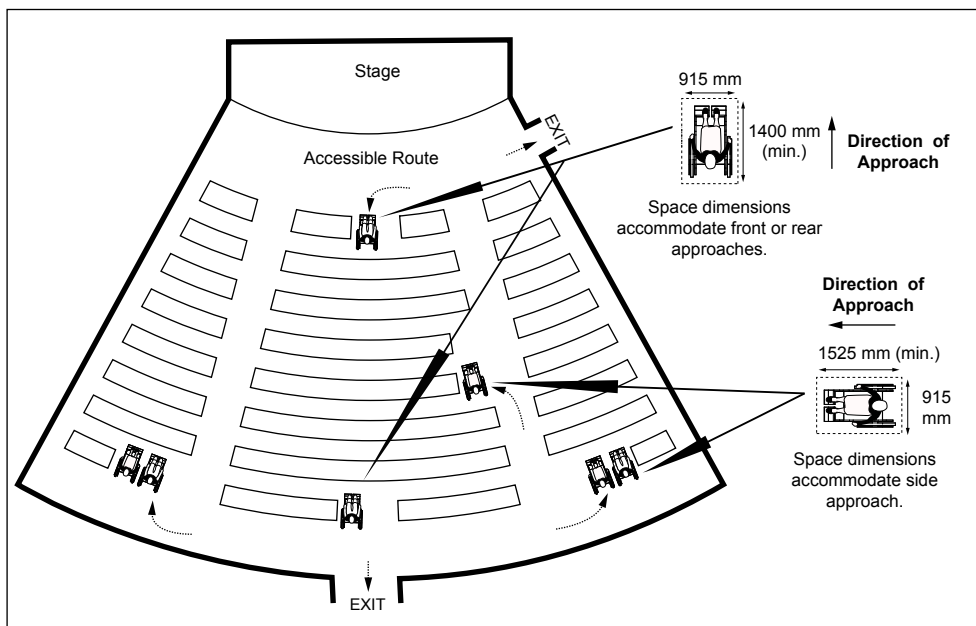

Figure 79: Accessible Seating Plan - Example of Viewing Positions



Designated accessible seating area at stadium.

6.1.2.3 Adaptable Seating

- a. locate adjacent to an accessible route without infringing on egress from any row of seating or any aisle requirements;
- b. equip with a movable or removable armrest on the side of the seat adjoining the accessible route; and
- c. locate, as part of the designated seating plan, and provide a choice of viewing location with a clear view of the event taking place.

6.1.2.4 Storage for Mobility Aids

- a. ensure at least one (1) storage space where not more than 200 fixed seats is provided and a minimum of two (2) storage spaces, where more than 200 fixed seats are provided;
- b. provide a clear floor space of 915 mm wide by 1370 mm deep (minimum) for each space; and
- c. locate storage space on the same level and in proximity to the accessible seating spaces and seats designated as adaptable seating.



Meeting and Multi-Purpose Rooms

6.2

Application

This section applies to highly-used and large meeting and multi-purpose rooms used by public and staff within a facility.

Note

Meeting rooms are intended to be flexible (e.g., with movable seating) in order to accommodate a wide range of uses, group sizes (e.g., dependant upon overall size of space) and the needs and preferences of the widest range of participants as possible. With movable seating available at all times for small and large meeting rooms, the intent is that a minimum of 2 accessible seating spaces can be made available, one on each side of a table for smaller spaces. For larger spaces, accessible seating spaces are expected to be available on all sides of a table. When a meeting room is not in use, seats are to be removed from accessible seating spaces and placed to ensure accessible path of travel throughout room is not obstructed.

Some facilities may limit uses due to the classification and type of building, but maximum flexibility is expected to be built into the design to accommodate any changing needs of occupants over time.

Reference

- Sec. 2.10 Seating, Tables and Work Surfaces
- Sec. 4.3 Interior Accessible Routes
- Sec. 5.1 Controls and Operating Mechanisms
- Sec. 5.2 Assistive Listening Systems
- Sec. 5.7 Lighting
- Sec. 5.8 Signage and Wayfinding

Best Practice

The procurement of furniture and equipment for different types of meeting and multi-purpose rooms should ensure that maximum flexibility and accessible options are always available.

Best Practice

Entrances to large and highly used meeting or multi-purpose rooms to be equipped with power door operators.

Clear floor space of 2500 mm by 2500 mm within the room is recommended where space is available.

Movable tables and seating are recommended as they allow flexibility and accommodations to be made.

Note

For larger multi-purpose meeting rooms, consider ways to allow easy and logical subdivision of the room (e.g., partitioning using automatic movable walls, that provide acoustic and visual barriers.

6.2.1 Design and Layout

- locate on an accessible path of travel;
- identify meeting / multi-purpose room(s) location with appropriate signage;
- ensure a consistent accessible path of travel of 1100 mm clear width (minimum) is provided throughout space for circulation (**Figure 80**);
- provide a turning diameter of at least 1675 mm within the room;
- provide accessible tables and work surfaces with suitable knee clearances and seating, as identified in related sections;
- provide assistive listening systems, identified with signage and International Symbol for Hearing Loss;
- where servery or millwork are provided, ensure clear floor space is:
 - 915 mm wide by 1370 mm deep (minimum) for forward approach; and
 - 1525 mm wide by 915 mm deep (minimum) for side approach;
- ensure all audio-visual equipment, features, controls and related technology are usable by all participants and staff, where applicable, including the provision of instructions and guidance in alternative formats; and
- provide lighting in accordance with Section 5.7 Lighting requirements, as applicable, at work surfaces.

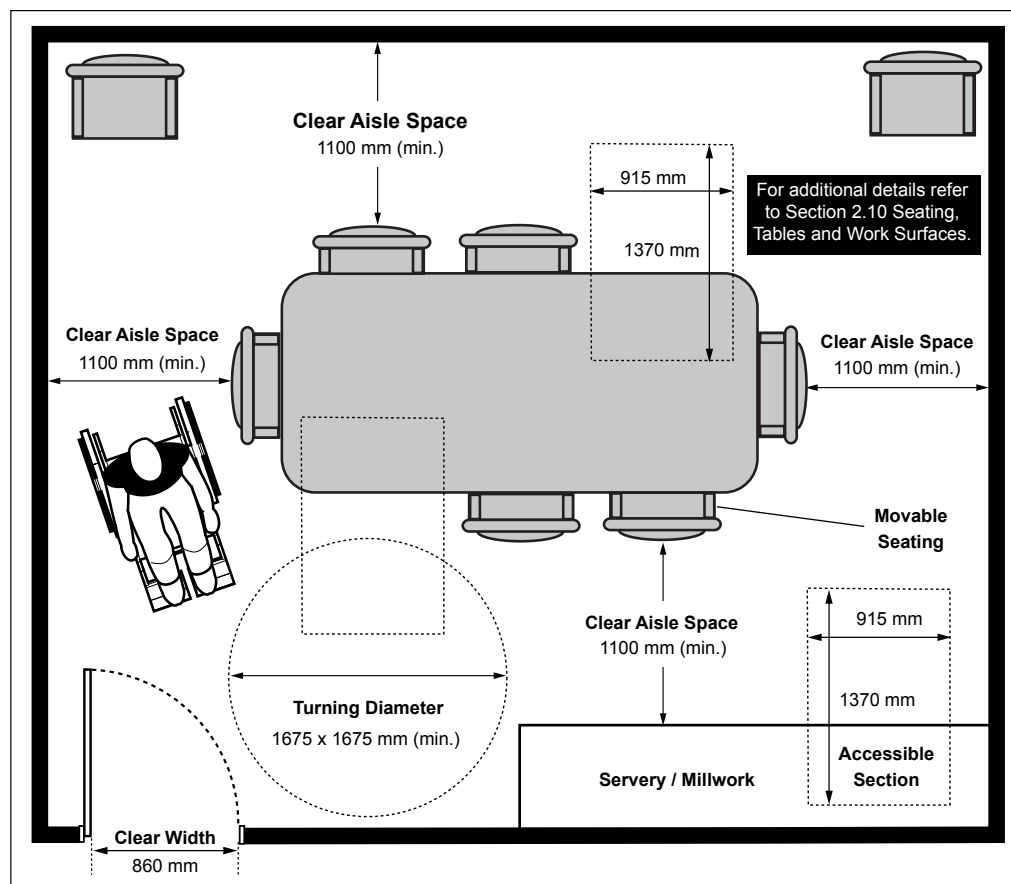

Figure 80: Meeting Room Design and Layout



Cultural and Art Facilities

6.3

Application

This section applies to cultural and art facilities, which include, but are not limited to, art galleries, concert halls, theatres, museums and heritage sites.

Recognizing there are unique circumstances and challenges related to improving accessibility of heritage sites and facilities, additional considerations beyond architectural and physical design are often required. These can include staff training and awareness, additional use of technology and implementation of facility-specific management policies and practices.

Reference

- Sec. 2.5 Overhanging and Protruding Objects
- Sec. 2.10 Seating, Tables and Work Surfaces
- Sec. 4.1 Entrances
- Sec. 4.2 Doors and Doorways
- Sec. 4.3 Interior Accessible Routes
- Sec. 5.1 Controls and Operating Mechanisms
- Sec. 5.2 Assistive Listening Systems
- Sec. 5.7 Lighting
- Sec. 5.8 Signage and Wayfinding

Best Practice

Provide line drawings and photographs that complement any labels or text provided, to aid in comprehension for those with reading difficulties.

Provide exhibits and display labels in alternative formats (e.g., Braille or audio).

Refer to the Ontario Historical Society's "Accessible Heritage: An Accessible Toolkit for Ontario's Heritage Organizations and Institutions."

6.3.1 Design and Layout

- a. ensure accessible path of travel 1100 mm (minimum) wide throughout circulation space;
- b. where exhibits or displays follow a specific order, ensure circulation route is intuitive;
- c. provide an accessible floor plan or map to facilitate in wayfinding;
- d. provide assistive listening systems in large assembly, meeting or performance areas; and
- e. where exhibits and displays are provided:
 - i. mount top surface of display cases at 915 mm high (maximum) from floor;
 - ii. provide clear floor space of 915 mm wide by 1370 mm deep (minimum) for forward approach and 1525 mm wide by 915 mm deep (minimum) for side approach in front of exhibits;
 - iii. provide a high tonal contrast between the items exhibited and adjacent background;
 - iv. eliminate or minimize glare that may be reflected from display surfaces or covers;
 - v. provide lighting in accordance with Section 5.7 Lighting requirements, as applicable, at display labels for reading; and
 - vi. where interactive displays are provided, ensure controls and operating mechanisms are mounted at 1100 mm high (maximum) from floor.



Interactive displays provide an alternative format to experience a space / exhibit.



Cafeteria and Dining Facilities

6.4

Application

This section applies to elements unique to cafeterias and dining facilities. Typical considerations include:

- serving line and seating areas with lower sightlines, reachable surfaces and displays for users of mobility aids;
- clear aisle and floor space for overall circulation; and
- independent access.

Reference

- Sec. 2.10 Seating, Tables and Work Surfaces
- Sec. 4.3 Interior Accessible Routes
- Sec. 5.1 Controls and Operating Mechanisms
- Sec. 6.10 Service Counters
- Sec. 6.11 Waiting and Queuing Areas

Note

Providing accessible customer service is especially important for this type of environment.

Best Practice

Provide clear floor space with turning diameter of 1675 mm, to allow both side and frontal approach of larger wheeled mobility aids such as powered scooters and wheelchairs.

6.4.1 Design and Layout

- a. provide a consistent accessible path of travel of least 1100 mm wide throughout spaces for circulation; and
- b. where layout of cafeteria amenities are dispersed, ensure clear floor space in front of food displays and dispensing equipment of:
 - i. 915 mm wide and 1370 deep (minimum) for forward approach; and
 - ii. 1525 mm wide and 915 mm deep (minimum) for side approach.

6.4.2 Food Displays and Service Lanes

Where self-service food displays are provided:

- a. ensure clear aisle width between tray slide and separating rail is 1100 mm (minimum) (**Figure 81b**);
- b. provide tray slides mounted between 730 and 865 mm high above floor;
- c. ensure at least 50% of shelves are mounted 400 to 1370 mm high for unobstructed side approach (**Figure 81a**); and
- d. ensure maximum side reach of 500 mm deep.

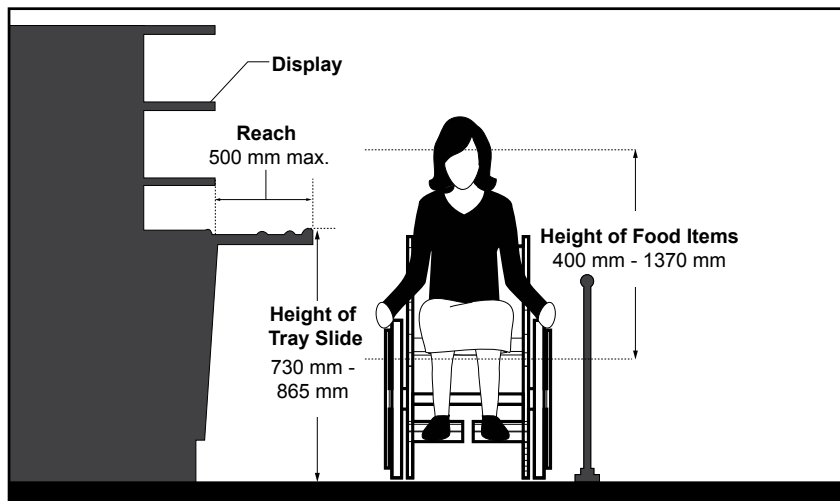

Figure 81a: Food Displays and Tray Slides - Section View

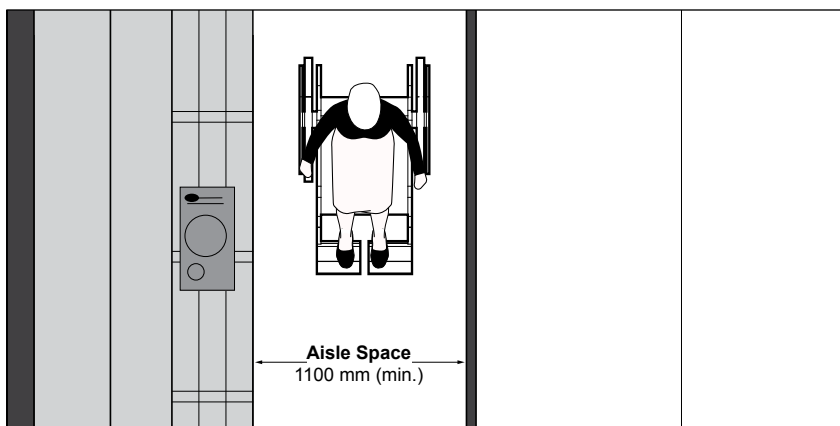

Figure 81b: Aisle Width - Plan View

6.4.3 Service and Payment Counter

- a. where provided, ensure at least one accessible service counter;
- b. provide a clear floor space for:
 - i. forward approach of 915 mm wide by 1370 mm deep; and
 - ii. side approach of 1525 mm wide by 915 mm deep; and
- c. ensure staff are visible from a seated position, to assist users if required.

6.4.4 Dining Areas

- a. ensure accessible seating spaces are provided for users of mobility aids;
- b. provide dining tables with clear knee space underneath table, as identified in relevant sections;
- c. provide a clear floor space of 1675 mm wide by 1675 mm deep (minimum) in front of dining areas; and
- d. provide informational and directional signage identifying accessible amenities, with International Symbol of Accessibility.

Best Practice

Refer to the AODA Customer Service Standards, Ontario Regulation 429 / 07.

Flexible seating and tables allow easier accommodations for all users.



Accessible cafeteria seating area designated with International Symbol of Accessibility.



Application

This section applies to common-use kitchens and kitchenettes, for public and staff, typically available as amenities in public facilities, such as office environments and community centres, where multi-purpose activity rooms are provided.

Reference

- Sec. 2.1 Ground and Floor Surfaces
- Sec. 2.10 Seating, Tables and Work Surfaces
- Sec. 4.3 Interior Accessible Routes
- Sec. 5.1 Controls and Operating Mechanisms
- Sec. 5.7 Lighting

6.5.1 Design and Layout

- a. ensure floor surface is slip-resistant and has a non-glare finish;
- b. ensure the following minimum clear floor space is provided directly in front of kitchen amenities and appliances, and to the one side where drawers or door open:
 - i. 915 mm wide by 1370 mm deep for forward approach;
 - ii. 1525 mm wide by 915 mm deep for side approach;
- c. ensure all controls and operating mechanisms are mounted no higher than 1100 mm from floor; and
- d. provide lighting in accordance with Section 5.7 Lighting requirements, as applicable, with task lighting option also available (e.g., under counter).

Best Practice

A turning circle of 2500 mm is preferred for users of larger mobility aids, including powered scooters and wheelchairs.

6.5.1.1 Pass-through or Galley Kitchens

For kitchens where counters, appliances or cabinets are on two opposing sides or opposite a parallel wall (**Figure 82**):

- a. provide a clearance of at least 1500 mm between all opposing base cabinets, countertops or walls within kitchen work areas; and
- b. ensure two doorways or openings are provided, with one at each end and with 860 mm clear width.

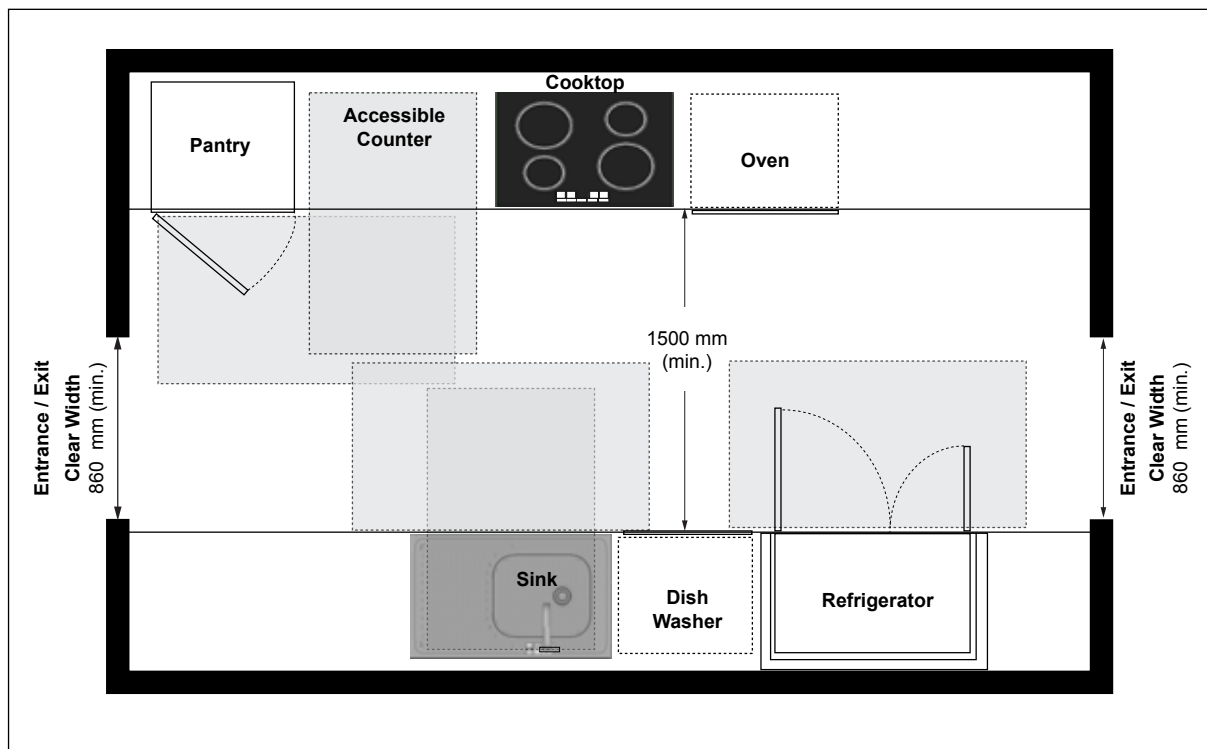

Figure 82: Pass-Through or Gallery Kitchen - Plan View

6.5.1.2 U-shaped Kitchens

Where kitchens are enclosed on three continuous sides (**Figure 83**):

- provide a clearance of at least 1500 mm between all opposing base cabinets, countertops or walls within kitchen work areas; and
- ensure entrance / exit clear width is at least 860 mm.

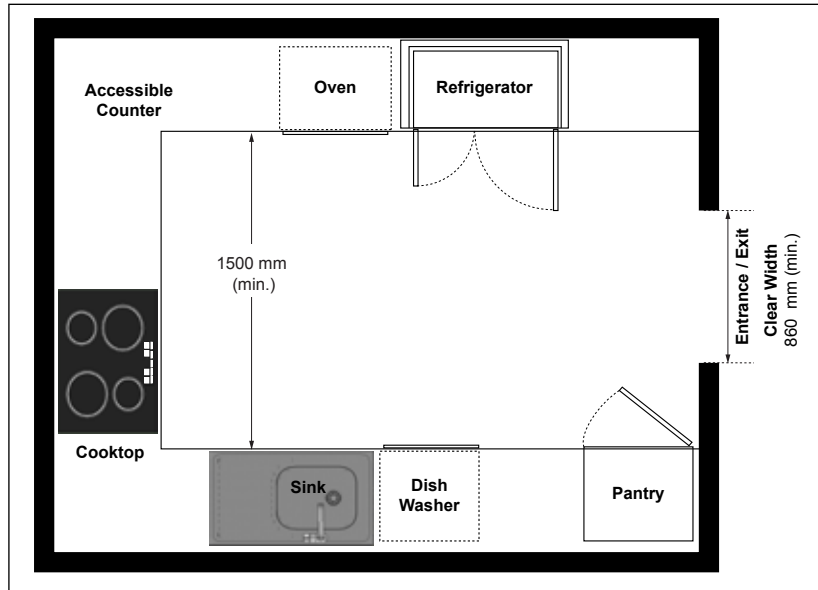

Figure 83: U-Shaped Kitchen - Plan View

6.5.1.3 L-shaped Kitchens

Where kitchens are L-shaped (**Figure 84**):

- provide a clearance of at least 1500 mm between all opposing base cabinets, countertops or walls within kitchen work areas.

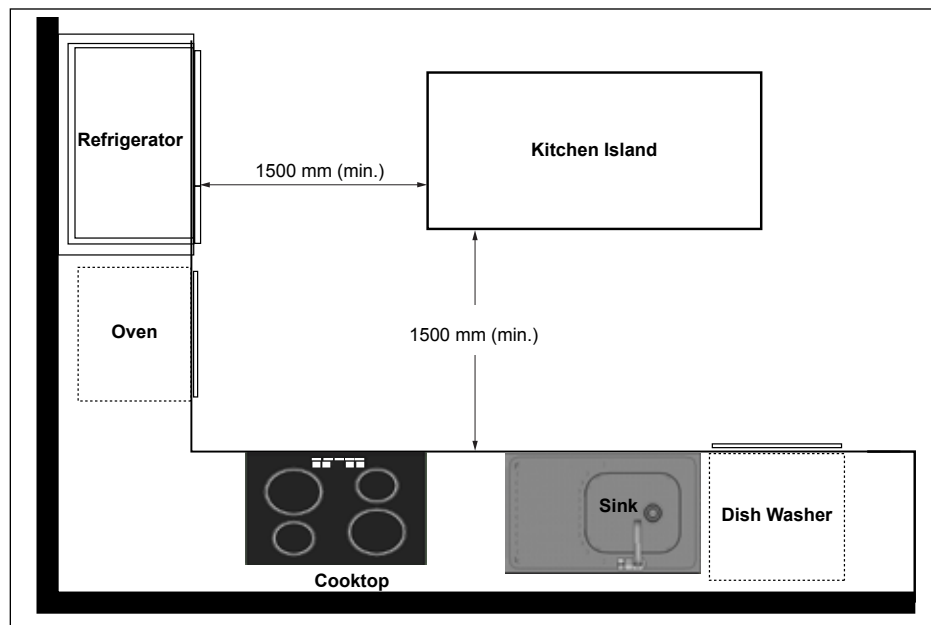

Figure 84: L-Shaped Kitchen - Plan View

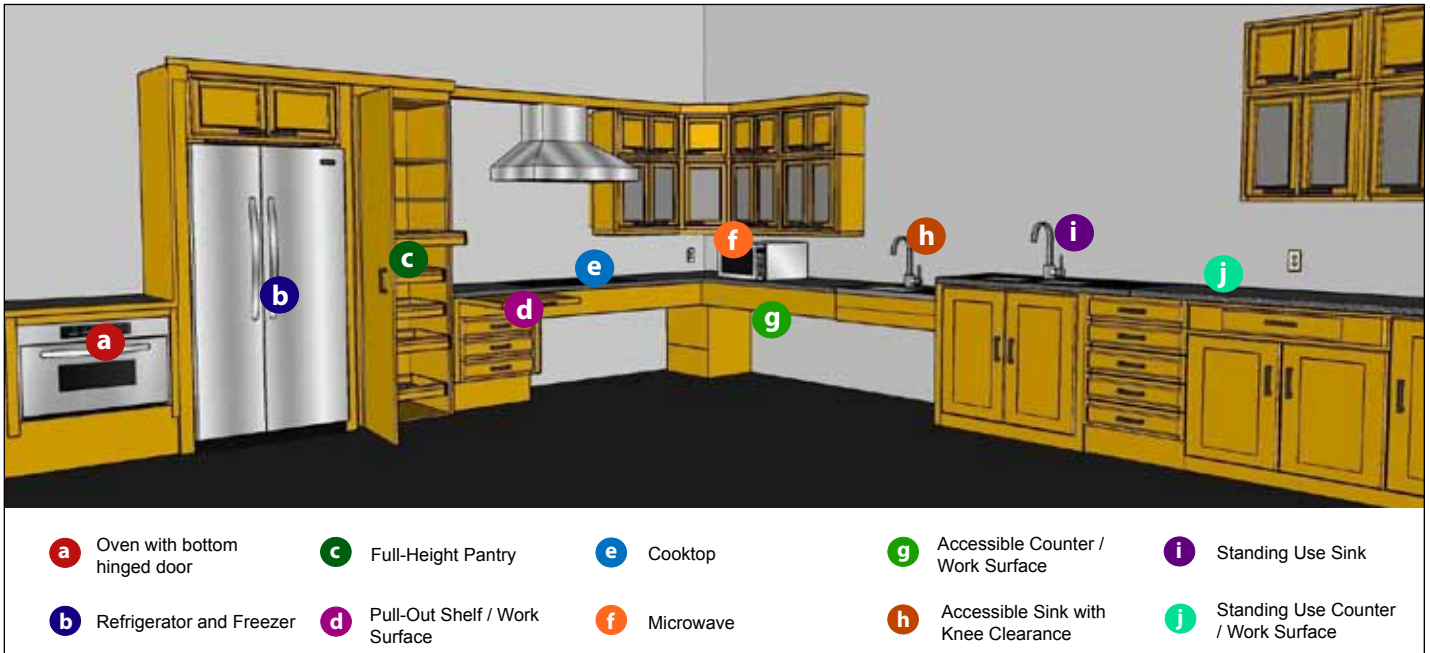

Figure 85: Example of Kitchen with Typical Amenities and Appliances

6.5.2 Counters and Work Surfaces

For accessible food preparation counters and work surfaces:

- a. provide a high tonal contrast between all cabinets, countertops, appliances and adjacent wall surfaces;
- b. ensure there are no sharp or abrasive surfaces underneath counter and work surfaces;
- c. ensure at least one (1) counter / work surface is accessible with:
 - i. dimension of 760 mm wide by 600 mm deep (minimum);
 - ii. top surface between 730 mm and 865 mm high (**Figure 86**);
 - iii. a centred knee clearance at least 480 mm deep, 760 mm wide and 685 mm high;
 - iv. a clear floor space of at least 915 mm wide by 1370 mm, which may extend up to 480 mm underneath the counter / work surface; and
 - v. electrical outlets installed at the side or front of it.

Best Practice

Tonal contrasted front edges on the counters help define the user space.

Provide a portable, accessible side counter unit for frequently used appliances and related amenities. This can also be an option for existing facilities.

An additional pull-out workboard below the standard counter surface is recommended.

Continuous countertops are recommended.

Note

Where kitchen islands are provided, consider providing lowered counter with knee clearance.

Best Practice

For kitchen storage, provide shelving above the counter and drawers or pull-out shelves below the counters.

Full-height storage cabinets provide a good range of accessible storage, which is particularly useful because in accessible kitchens, the amount of base storage is reduced by the knee clearance provisions.

Full-extension drawers and shelves provide storage space that is easy to reach and use.

“Lazy Susan” trays also provide accessible storage.

6.5.3 Kitchen Storage

Kitchen storage includes but is not limited to shelves, storage cabinets and drawers. Where provided:

- ensure at least one (1) storage unit is 1100 mm (maximum) high from floor where it is mounted above a counter / work surface;
- provide accessible cabinet door hardware (e.g., D-type door pull):
 - mount no higher than 1100 mm from floor (**Figure 86**);
 - mount close to the bottom for upper cabinets and close to the top for base cabinets; and
- ensure toe space of 150 mm deep by 230 mm high (minimum) is provided at base cabinets, where provided (**Figure 87**).

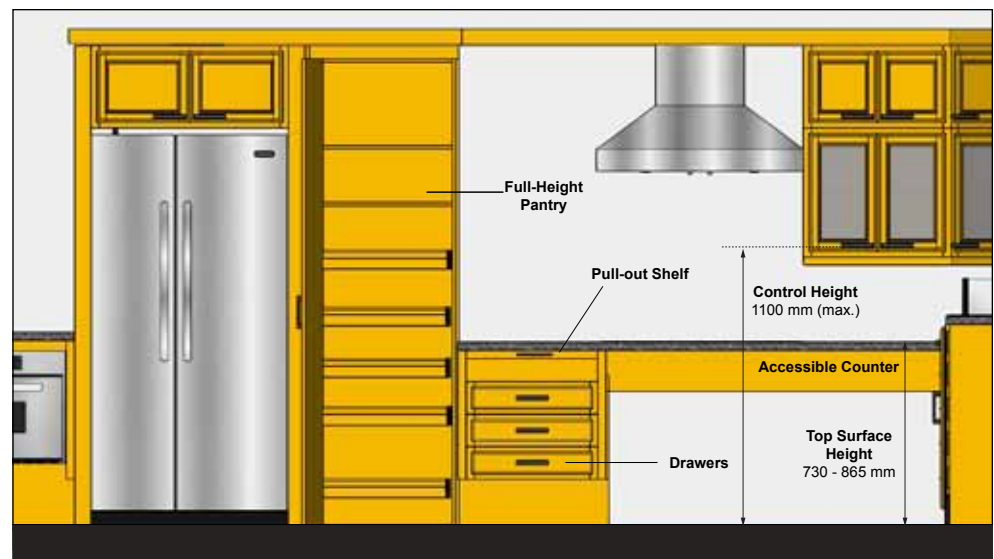

Figure 86: Kitchen Storage - Elevation View

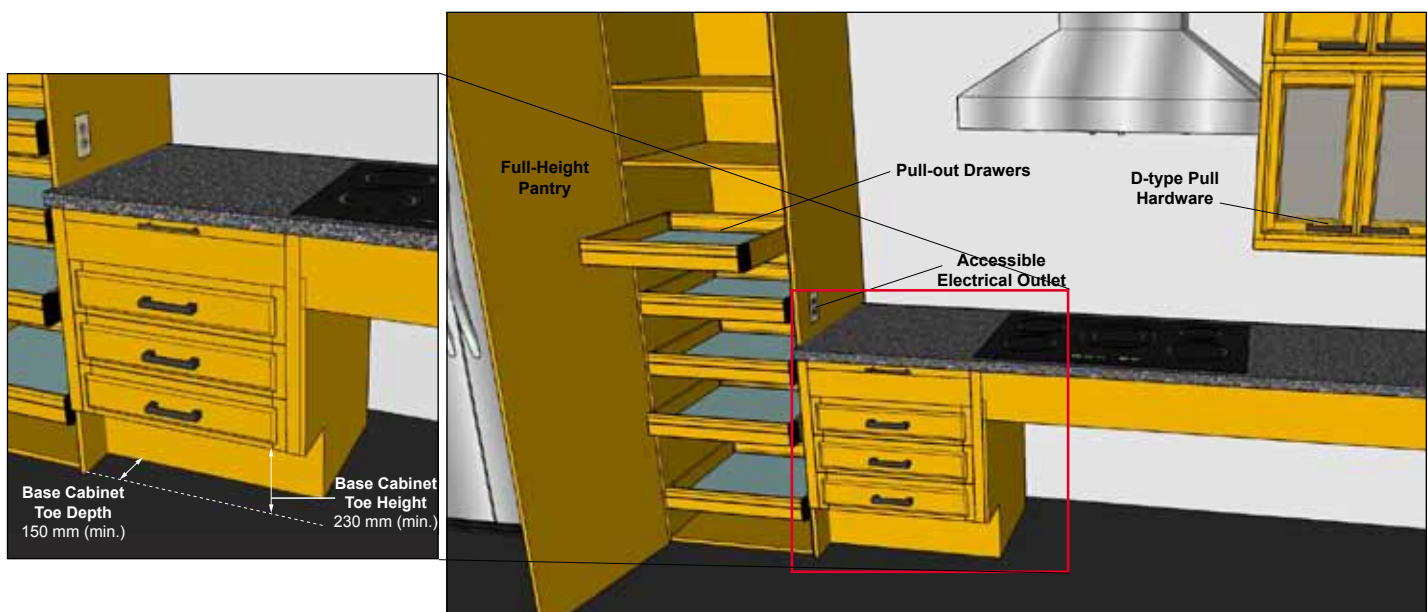

Figure 87: Kitchen Storage

6.5.4 Sinks

- a. install sink with its centreline at 460 mm (minimum) from a side wall;
- b. ensure the rim height of sink is located between 810 to 860 mm high above floor (**Figure 88**);
- c. provide knee clearance centred on the sink no less than 920 mm wide by 685 mm high by 200 mm deep;
- d. where toe clearance is provided, ensure it is 230 mm high by 230 mm deep (minimum);
- e. provide automatic faucet or lever-type controls that can be operated with one closed fist;
- f. ensure no sharp or abrasive surfaces under it;
- g. ensure hot water and drain pipes underneath sink are offset to the rear and do not obstruct the knee clearance (**Figure 89**); and
- h. where hot water and drain pipes about the knee clearance, ensure pipes are insulated or covered to protect users.

Best Practice

Faucets with a flexible hose attachment benefit a wider range of users.

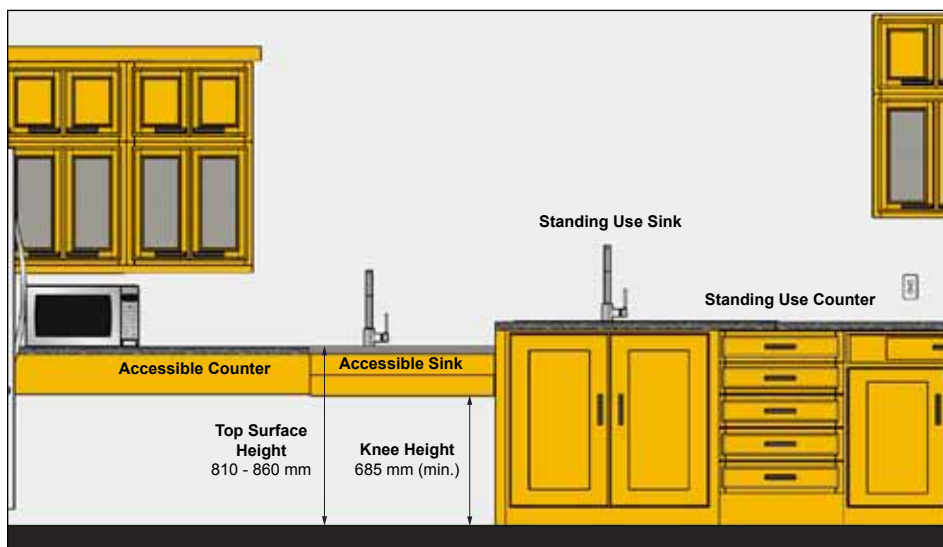

Figure 88: Sink - Elevation View

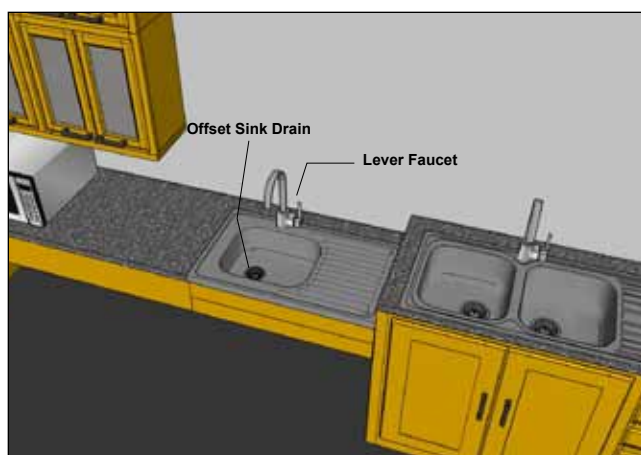

Figure 89: Accessible Sink

Note

Cooktops with flat ceramic surfaces should not be used for people with low vision.

6.5.5 Kitchen Appliances

Kitchen appliances include but are not limited to cooktops, microwaves, ovens, refrigerators and freezers (**Figures 85**).

6.5.5.1 Cooktops

Where provided (**Figure 90 and 91**):

- a. use appliance models where controls are located away from the burners (e.g., do not require reaching across heating surface to operate);
- b. ensure a clear floor space of 915 mm wide by 1370 mm deep (minimum), which may extend up to 480 mm underneath the cooktop, is provided;
- c. ensure top surface height is located between 810 and 860 mm from the floor;
- d. provide a knee clearance centred on the cooktop of at least 760 mm wide by 685 mm high by 200 mm deep, with additional toe clearance of 230 mm deep by 230 mm high (minimum);
- e. provide insulation or other protection on the underside where knee clearance is provided; and
- f. provide a work surface on each side and at the same height as the cooktop:
 - i. width of 400 mm (minimum); and
 - ii. ensure surface is heat resistant.

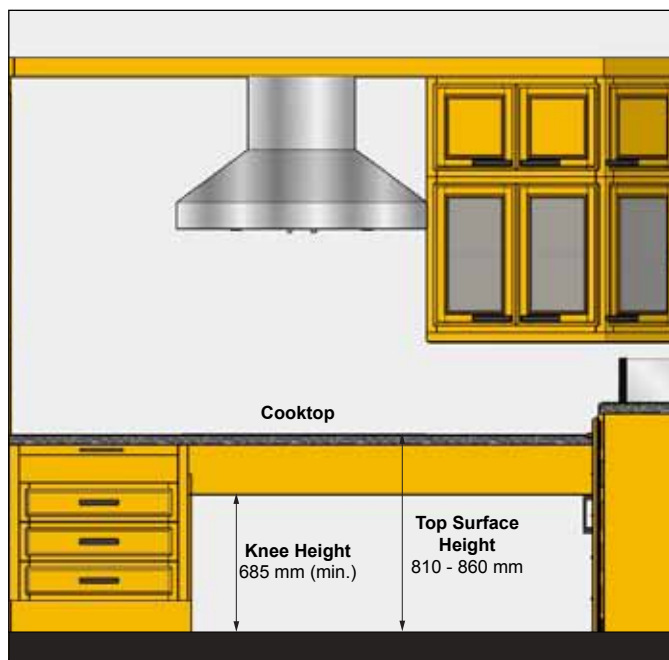

Figure 90: Cooktop - Elevation View

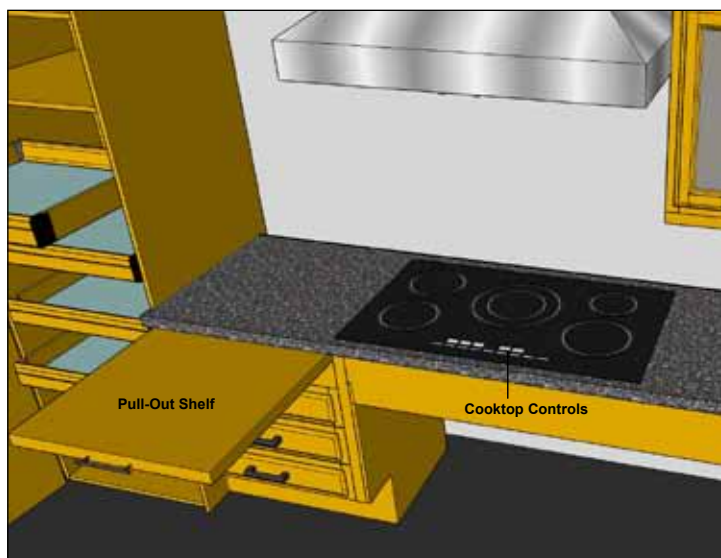

Figure 91: Cooktop

6.5.5.2 Ovens

Where provided (**Figure 85**):

- a. ensure oven controls are located on the front panels of oven;
- b. where microwave ovens are provided, mount at counter height;
- c. where ovens with side-hinged doors are provided:
 - i. provide heat resistant work surfaces with knee space below, adjacent to the latch side of oven door; or
 - ii. incorporate a heat resistant pull-out shelf that pulls out 250 mm (minimum) below the oven; and
- d. where ovens with bottom-hinged doors are provided, provide work surface on one side of the door.

6.5.5.3 Refrigerators and Freezers

Where provided:

- a. provide a self-defrosting freezer;
- b. provide a vertical side-by-side type refrigerator / freezer as they are more accessible;
- c. where an over- and-under type refrigerator is used, ensure the freezer shelf space is not more than 1100 mm high from the floor; and
- d. provide clear floor space in front of refrigerators / freezers, positioned for parallel approach immediately adjacent to refrigerator / freezer, with the centreline of the clear floor space offset 610 mm (maximum) from the front face (**Figure 92**).

Best Practice

Wall ovens with side-opening door are not recommended.

Roll-out shelves or drawers improve access to the refrigerator contents.

Note

Models with freezers at the bottom are recommended, if an over-and-under refrigerator type is provided.

Additionally, floor space should be provided to pull up to the refrigerator / freezer in a mobility aid. This allows opening and closing of the door and ensures space to open the door.

Through-the-door ice and water dispensers are convenient for many users.

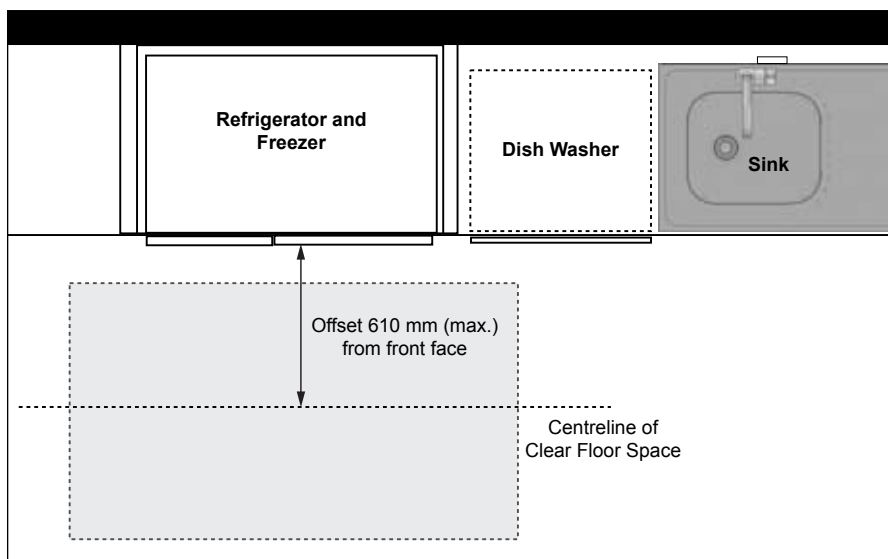
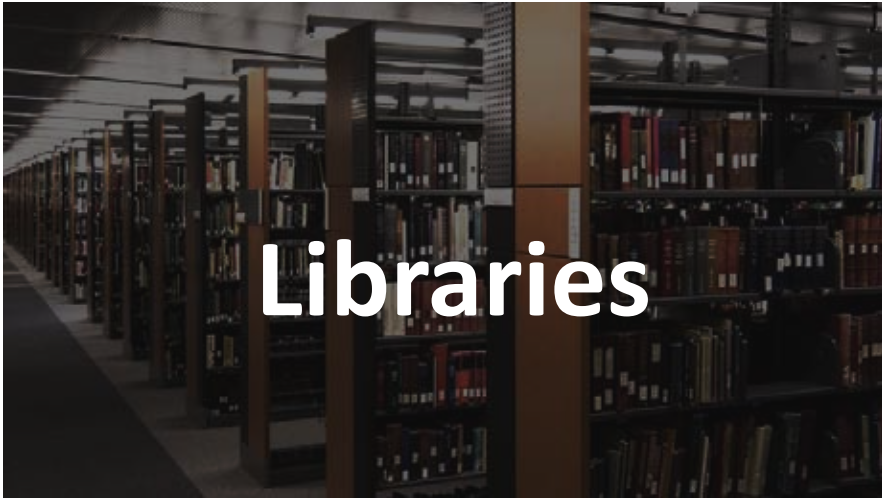

Figure 92: Clear Floor Space at Refrigerators and Freezers



Libraries



6.6

Application

This section applies to libraries or a designated room in a facility that is used for the same purpose.

It is recognized that libraries have unique space requirements in order to accommodate book stacks and reference materials at both high and low shelving heights. Shelving heights in collection areas with book stacks is unrestricted where City Staff are available to assist users when requested. Ensure Staff availability is coordinated as part of a formal Accessible Customer Service policy, practice or procedure that is in place for all Library facilities.

Reference

- Sec. 2.10 Seating, Tables and Work Surfaces
- Sec. 4.3 Interior Accessible Routes
- Sec. 5.1 Controls and Operating Mechanisms
- Sec. 5.7 Lighting
- Sec. 5.8 Signage and Wayfinding
- Sec. 6.10 Service Counters
- Sec. 6.11 Waiting and Queuing Areas

6.6.1 Design and Layout

- provide a consistent accessible path of travel of at least 1100 mm wide throughout spaces for circulation;
- provide turning diameter of 1675 mm in order to allow users of mobility aids to make a 180° turn;
- where provided, ensure security gates have a clear width of 915 mm (**Figure 93**);
- provide at least one accessible service counter at circulation, information or self-service checkout areas;
- where online catalogues or other workstations are provided, ensure at least 25% are accessible;
- provide lighting in accordance with Section 5.7 Lighting requirements, as applicable;
- ensure acoustic quality is free of unnecessary background noise;
- provide informational and directional signage where any services or amenities for users with disabilities are available on different floor levels (e.g., Information or Customer Service Desks); and
- ensure library staff are provided with disability awareness / sensitivity training.

Best Practice

Provide alternative formats for key resources based on user requests and through development of partnerships with other organizations (e.g., CNIB, Canadian Hearing Society). This includes considerations related to the availability of Audio Books on CD-ROM for users with low literacy or who have a vision loss, as well as Closed Captioning options for any audio / visual media, for users with hearing loss.

Clear width of 1800 mm is preferred at main circulation routes in order to accommodate higher volumes of traffic.

Where space is available, a clear floor space of 2500 mm is recommended to allow users of mobility aids to make a 180° turn within the aisle configuration.

Note

Refer to AODA Customer Service Standard, Ontario Regulation 429 / 07.

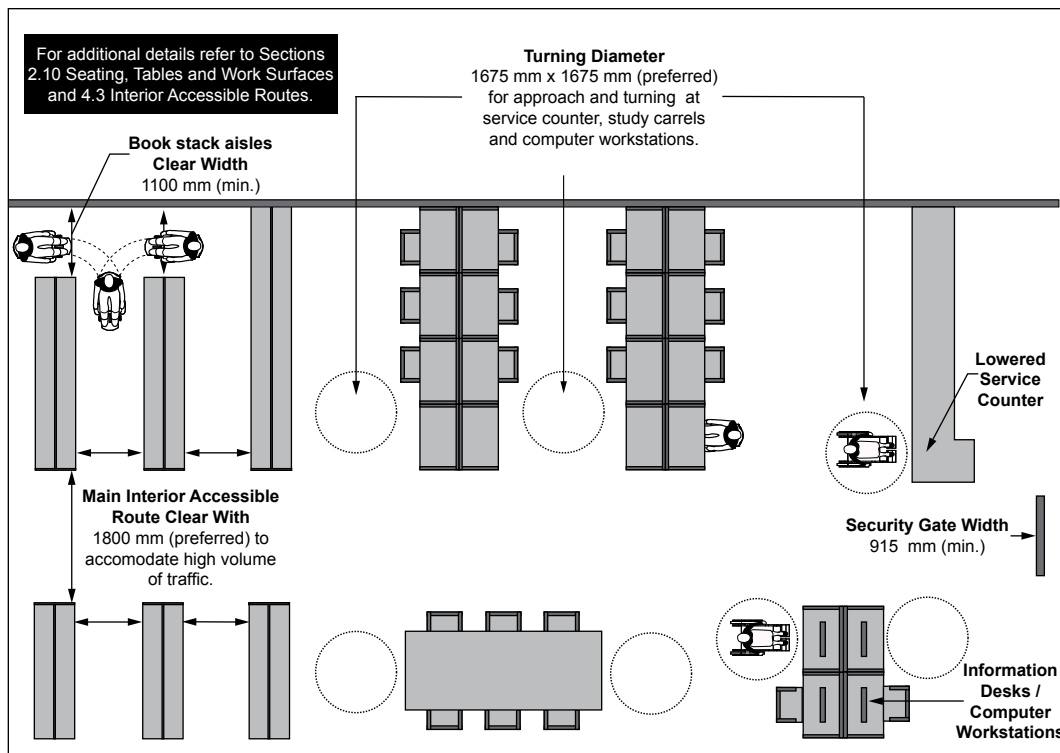

Figure 93: Library Design and Layout - Plan View

6.6.2 Book Drop Slots

- a. locate on an accessible path of travel;
- b. provide clear floor space in front of drop slot:
 - i. 915 mm wide by 1370 mm deep for a forward approach; and
 - ii. 1525 mm wide by 915 mm deep for a side approach;
- c. ensure a high tonal contrast between drop slot and mounting surface;
- d. locate slot between 900 and 1100 mm above the floor (**Figure 94**); and
- e. ensure slot controls are usable with closed fist and operable with one hand.

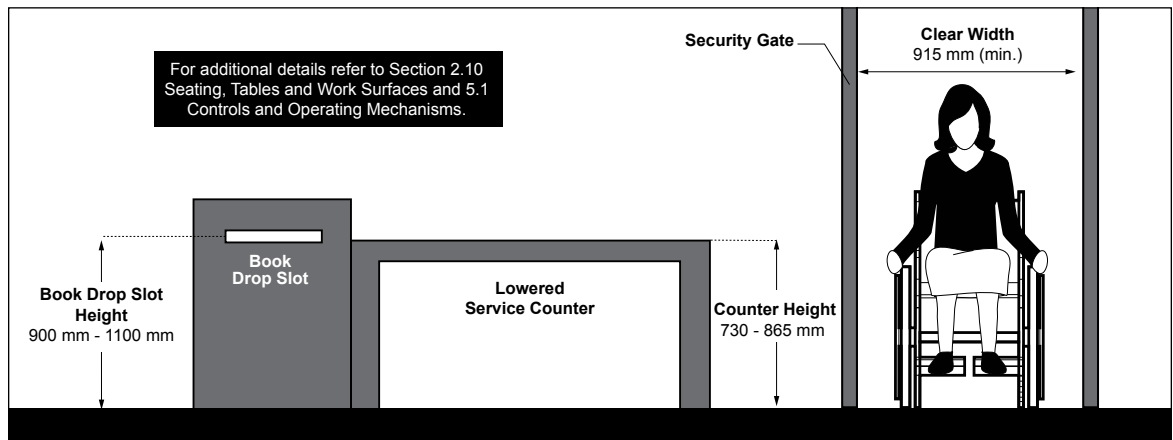

Figure 94: Library Security Gate, Service Counter and Book Drop Slot

Best Practice

Where more frequently used or referenced materials are provided, such as newspapers, periodicals, pamphlets and community brochures for example, a mounting height between 400 mm and 1100 mm high is required to accommodate the reach ranges of diverse users, including small children, seniors and users of mobility aids.

6.6.3 Book Stacks or Carousels

- a. ensure accessible path of travel of at least 1100 mm between aisles (**Figure 95**);
- b. ensure library policy is in place to provide assistance for users to access items that are too high or too low; and
- c. ensure large print collection and heavier materials are placed on lower shelves for easy access.

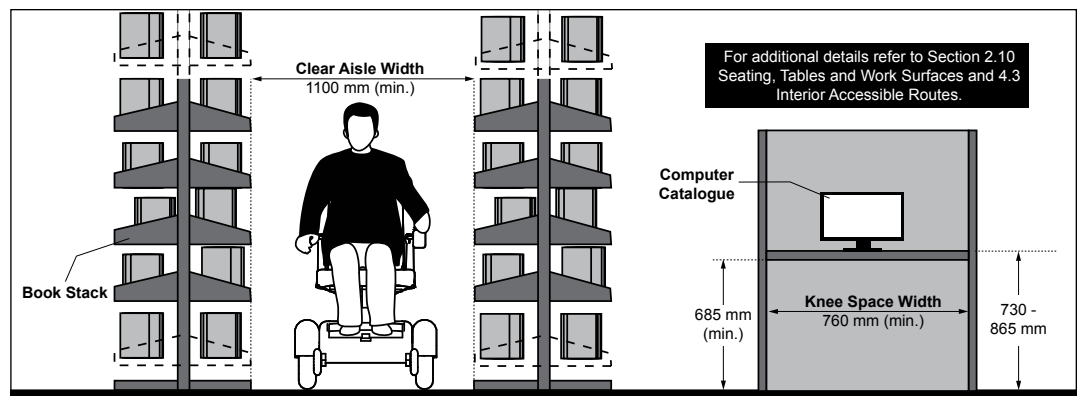

Figure 95: Book Stacks

6.6.4 Reading Lounges and Study Areas

- a. provide a variety of flexible seating options;
- b. ensure a high tonal contrast is provided between furniture and their surroundings;
- c. ensure all study tables, study carrels and work surfaces provide suitable knee and toe clearances with at least 10% of each surface type fully accessible; and
- d. incorporate an electric outlet.

Best Practice

Ensure accessible workstations have height adjustable surface and are equipped with adaptive technology (e.g., flexible mouse control and scrolling feature). Ensure at least one accessible workstation has specialized equipment for users with vision loss (e.g., screen reader software, scanner and CCTV magnifiers).



Recreational and Community Facilities

6.7

Application

This section applies to recreational and community facilities, whether indoor or outdoor, used by spectators, participants, volunteers, coaching staff and facility employees. Recreational and community facilities include, but are not limited to:

- courts (e.g., basketball, volleyball, tennis);
- fields (e.g., baseball, soccer, football);
- arenas (e.g., ice pad, skating rinks);
- aquatic facilities (e.g., swimming pools, spas, wading pools, splash pads, saunas);
- gymnasiums; and
- exercise and fitness facilities.

Criteria in this section requires detailed review and application based on the type of facility, level of use and number of features or elements provided (e.g., total number of change rooms).

Reference

- Sec. 2.1 Ground and Floor Surfaces
- Sec. 2.2 Ramps
- Sec. 2.3 Stairs
- Sec. 2.4 Guards and Handrails
- Sec. 2.7 Tactile Walking Surface Indicators
- Sec. 2.10 Seating, Tables and Work Surfaces
- Sec. 5.2 Assistive Listening Systems
- Sec. 5.8 Signage and Wayfinding
- Sec. 6.1 Assembly Areas
- Sec. 6.8 Change Rooms

6.7.1 Design and Layout

The design and layout of recreational and community facilities, typically consists of the following elements.

6.7.1.1 Change Rooms

- provide at least one accessible change room, with at least one accessible change cubicle to accommodate parents with children, companions or care givers of the opposite sex.

6.7.1.2 Viewing Area

- provide level accessible seating spaces to accommodate users of mobility aids; and
- integrate assistive listening systems or visual equipment, depending on the type of venue.

6.7.2 Arenas

For access to ice pads and skating rinks in arenas:

- locate on an accessible path of travel;
- provide access panels to ice surface with clear width of at least 860 mm; and
- provide level or beveled access to ice pads or skating rinks.

6.7.3 Exercise and Fitness Facilities

- ensure accessibility features are provided, if available, for at least one of each type of equipment or machine; and
- provide a clear floor space of 915 mm by 1370 mm (minimum) for a front approach or 915 mm by 1525 mm for a side approach on one side of exercise equipment to allow transfer.

6.7.4 Aquatic Facilities

- ensure pool deck surfaces are firm, stable, slip-resistant and have a matte finish;
- ensure deck surface has running or cross-slope gradient no steeper than 1:50 (2%) for drainage of water;
- provide recessed drainage tiles with openings no greater than 13 mm wide;
- provide an accessible path of travel around the perimeter of pool deck at 1100 mm (minimum) wide;

Best Practice

Refer to Sledge Hockey Accessibility Design Guidelines for Arenas: http://www.hockeycanada.ca/index.php/ci_id/54204/la_id/1.htm

Best Practice

Provide an area for mobility aids or assistive devices to be stored so they do not obstruct circulation around pool deck.

Where space is available, provide a clear floor space of 1675 mm by 1675 mm for transfer to exercise equipment.

- e. provide tactile walking surface indicators (TWSI) 610 mm wide to clearly delineate the perimeter of the pool deck and locate where any area contiguous to the pool deck may be confused with the deck; and
- f. provide high tonal contrast on pool lane markers, related tie-off devices, starter blocks and any other permanent or temporary equipment (e.g., life-guard chairs, diving boards or platforms, safety equipment).

Best Practice

Where possible, provide sloped entry or ramp with running slope of no more than 1:20 (5%).

Note

Extensions are not required on bottom landing as they can be a bumping hazard for swimmers.

For new construction, ensure sloped entry or ramp is provided. Transfer lifts are permitted as an option for existing facilities that cannot be retrofitted to provide a sloped entry or ramp.

6.7.4.1 Entry and Exit Point

Provide at least one accessible entry and exit point:

- a. ensure entry and exit point is located away from any designated swimming lanes.

6.7.4.2 Sloped Entry or Ramp

- a. ensure running slope is no more than 1:12 (8.33%);
- b. provide handrails, mounted between 865 mm and 965 mm high from surface, extending at top landing only (**Figure 96**);
- c. ensure the clear width between handrails is 1100 mm (minimum);
- d. provide top and bottom landing of at least 1670 mm by 1670 mm;
- e. ensure water depth at the bottom of the ramp is at least 600 mm and not greater than 900 mm;
- f. provide a hard-surfaced area capable of accommodating a movable barrier separating the area from the deck, and is 750 mm (minimum) wide that is contiguous to the entire length of the part of the submerged ramp that pierces any part of the deck; and
- g. ensure the finishes in the submerged portions of the ramps and curbs are different in colour or shade from each other and from that of the pool walls and bottom.

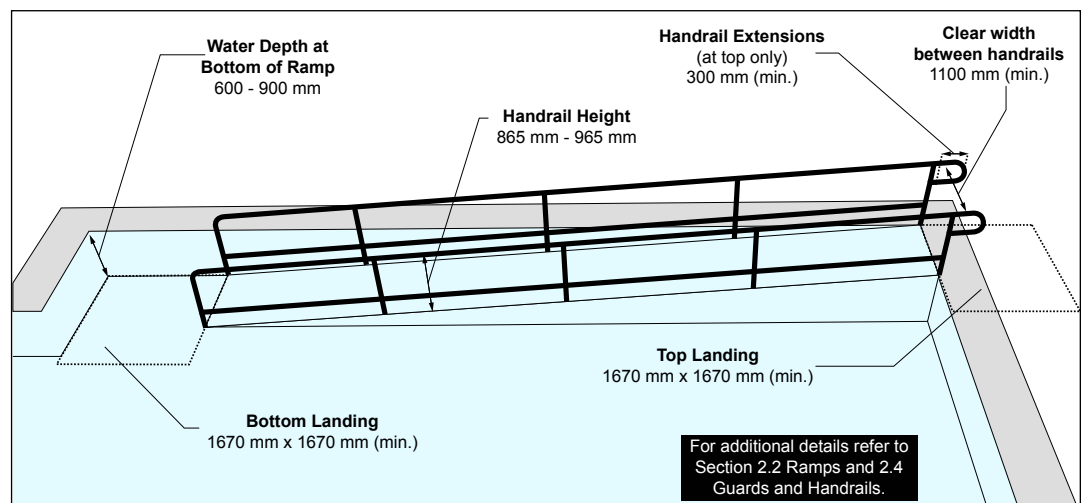

Figure 96: Sloped Entry or Ramp to Swimming Pool

6.7.4.3 Transfer Systems

Existing facilities without ramps are encouraged to secure a fixed transfer lift to support client needs.

6.7.4.4 Transfer Lifts

- a. locate transfer lifts on an accessible path of travel and in shallow end, where water level does not exceed 1200 mm high;
- b. ensure the centreline of the seat for the transfer lift is located over the deck and at 400 mm (minimum) from the edge of the pool when in the raised position;
- c. ensure seat is firm with suitable padding, with a minimum width of 400 mm;
- d. provide a clear deck space of 1675 mm by 1675 mm on the transfer side of the lift;
- e. ensure lift is designed to be operable without assistance from both the deck and water and when in use, its controls and operating mechanisms are unobstructed and mounted no higher than 1100 mm from pool deck or water surface; and
- f. ensure single user lifts have a minimum weight capacity of 135 kg and capable of sustaining a static load of at least 1.5 times the rated load.



Transfer lifts can be used as a means of assisted entry and exit point where an accessible entry / exit point can not be provided.



Change Rooms

6.8

Application

This section applies to change rooms, which may also be referred to as dressing / locker rooms or fitting areas, used by the public or staff. These spaces share common elements and design features. Typically, change rooms are provided in arenas, pools, fitness centres and related recreation / community centres.

Reference

- Sec. 2.1 Ground and Floor Surfaces
- Sec. 2.10 Seating, Tables and Work Surfaces
- Sec. 4.2 Doors and Doorways
- Sec. 4.3 Interior Accessible Routes
- Sec. 4.5 Washrooms
- Sec. 4.6 Showers
- Sec. 5.1 Controls and Operating Mechanisms
- Sec. 5.7 Lighting
- Sec. 5.8 Signage and Wayfinding

Note

The provision of Universal Change Rooms or Stalls as part of Change Rooms and related areas is dependant upon the type of facility. For a Pool facility, often a combination of shared and private spaces are provided for change areas, which often also integrate washroom and shower facilities as part of the overall design. The total number of universal change rooms or stalls should be identified based on the size and occupancy of each facility and the required fixture counts for washrooms and showers.

6.8.1 Provision and Location

For Universal Change Rooms or Stalls that are intended for private use in addition to other public or staff change rooms that may be available:

- a. provide at least one universal change room or stall for each type of other regular change room facility that is provided (e.g., Male, Female or Universal Change Room); and
- b. ensure universal change rooms or stalls are located along an accessible route.

Note

In a retrofit situation, 10% of change rooms, and never less than one, should be universal, for each type of other regular change room facility that is provided.

6.8.2 Design and Layout

- a. where doors are provided at the change room entrance, provide a clear width of 860 mm (minimum) and equip with power door operators;
- b. provide a consistent accessible path of travel 1100 mm (minimum) wide throughout spaces for circulation in the change room;
- c. ensure a clear turning diameter of 1500 mm (minimum) is provided inside change room circulation area to allow users of mobility aids to make a 180° turn;
- d. ensure the floor surface is slip-resistant and allows suitable drainage;
- e. where washroom facilities are provided as part of a change room, provide accessibility design requirements, in accordance with Section 4.5 Washrooms requirements, as applicable;
- f. where shower facilities are provided as part of a change room, provide accessibility design requirements, in accordance with Section 4.6 Showers requirements, as applicable;
- g. provide lighting in accordance with Section 5.7 Lighting requirements, as applicable; and
- h. provide an emergency call system with the following features:
 - i. includes an emergency bilingual sign containing the words “IN THE EVENT OF AN EMERGENCY PUSH EMERGENCY BUTTON AND AUDIBLE AND VISUAL SIGNAL WILL ACTIVATE” in letters at least 25 mm high with a 5 mm stroke, that is posted above the emergency button;
 - ii. consists of visual and audible signal devices both inside and outside of the change room that are activated by a control device inside the change room; and
 - iii. where facilities have the capacity and where staff is available, ensure the call system is linked to a display panel at a reception / information counter or to a centrally monitored station (e.g., security desk).

6.8.3 Change Room Amenities

Change room amenities typically include, but are not limited to, benches, lockers, showers and washrooms.

6.8.3.1 Permanent Benches

Where permanent benches are provided:

- a. provide seat height of 480 to 520 mm above finished floor to allow users of mobility aids to transfer;
- b. ensure seat depth between 510 mm to 610 mm, with back support, unless seat surface is permanently positioned against a wall; and
- c. provide high tonal contrast finishes to assist with distinguishing bench surfaces from surroundings.



Consistent accessible path of travel, space for circulation and lockers mounted at different heights.

6.8.3.2 Lockers

Where lockers are provided inside change rooms:

- a. ensure at least 10% of the total number of lockers but never less than one is designated as accessible;
- b. identify accessible lockers clearly with signage (e.g., International Symbol of Accessibility);
- c. provide a clear floor space in front of accessible lockers of:
 - i. 915 mm wide at 1370 mm deep (minimum) to allow for a forward approach; and
 - ii. 1525 mm wide by 915 mm deep (minimum) to allow a side approach;
- d. mount bottom shelf between 400 mm and 1200 mm high from the floor;
- e. ensure locking mechanism is mounted between 900 mm and 1100 mm high above floor; and
- f. ensure identification / number signage for all lockers:
 - i. is mounted no higher than 1500 mm (centre);
 - ii. provides lettering or number print size between 13 mm and 19 mm high, with either raised or recessed lettering; and
 - iii. provides a high tonal contrast with the background.

6.8.4 Universal Change Rooms or Stalls

- a. identify clearly with signage (e.g., International Symbol of Accessibility);
- b. provide a clear turning diameter of 1675 mm (minimum) inside of the change room or stall (**Figure 97a**);
- c. ensure floor surface is firm, level and slip-resistant;
- d. provide an entrance door or stall door with:
 - i. a clear width of 860 mm (minimum), when door is in an open position;
 - ii. a locking mechanism that can be locked from the inside and released from the outside, in case of emergency;
 - iii. spring hinges or gravity hinges in the case of a stall door, so that door closes automatically, where the door swings outwards; and
 - iv. a power door operator, where an entrance door is required for a private universal change room;
- e. provide a change bench 1830 mm long by 760 mm wide, mounted with top surface between 480 and 520 mm high;
- f. provide grab bars with specifications identified in Section 4.5.7 Grab Bars:
 - i. install one L-shaped grab bar at the end of the bench, with the vertical component, 150 mm (minimum) from front edge of seat and clearance of 150 mm (minimum) above the bench seat (**Figure 97b**);
 - ii. install one horizontal grab bar, 1200 mm (minimum) long, mounted 750 to 850 mm high and centered on the long side of the bench;
- g. provide motion sensor for automatic illumination of the interior, and lighting in accordance with Section 5.7 Lighting requirements, as applicable; and
- h. include a full length mirror.

Best Practice

A 2500 mm turning diameter inside universal change rooms or stalls is recommended, where space is available.

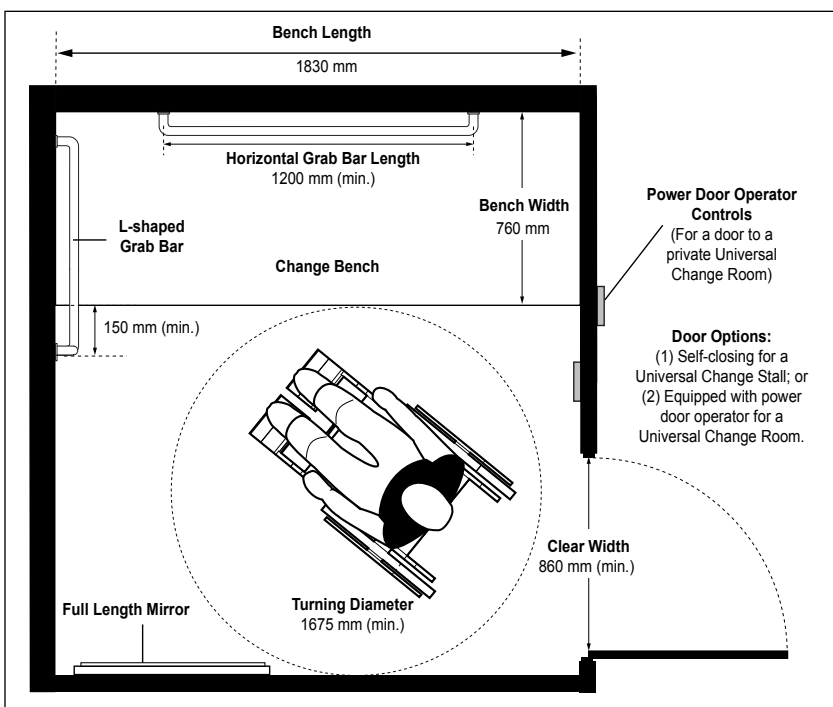

Figure 97a: Universal Change Room or Stall - Plan View

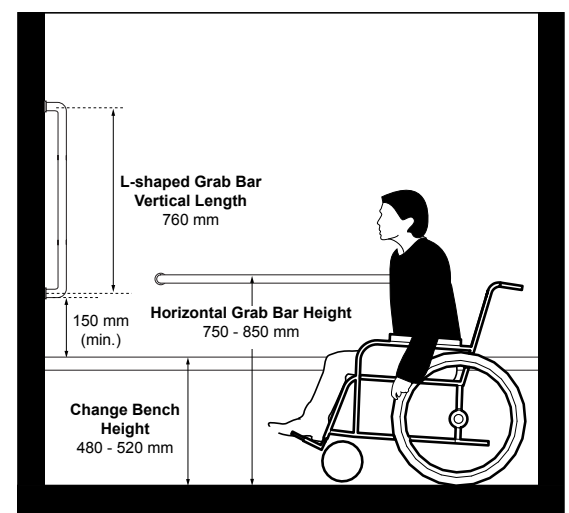

Figure 97b: Grab Bar Dimensions

Balconies and Terraces

6.9

Application

This section addresses spaces that may be used as exits and areas of refuge from public facilities, such as common-use balconies and terraces.

Reference

- Sec. 2.1 Ground and Floor Surfaces
- Sec. 2.4 Guards and Handrails
- Sec. 3.3 Exterior Paths of Travel
- Sec. 4.2 Doors and Doorways

Exception

This section does not address balconies and terraces within private residences.

6.9.1 Design and Layout

- a. locate on an accessible path of travel;
- b. ensure ground or floor surfaces are firm, slip-resistant with maximum gradient of 1:50 (2%) to permit drainage;
- c. provide depth of 2000 mm (minimum) (**Figure 98**);
- d. ensure threshold is beveled at slope of 1:2 (50%) (maximum), where transition is between 6 to 13 mm; ensure door stops and door sweeps do not prevent maneuverability;
- e. where doors open directly into a path of travel, provide cane detectable guards or other protective barriers located perpendicular to the door; and
- f. where guards are provided, design to facilitate visibility from seated position.

Note

Where spacers for drainage are provided, on ground surface, ensure maximum width of 6 mm between each.

Guards at balconies and terraces may consist of vertical pickets or glass.

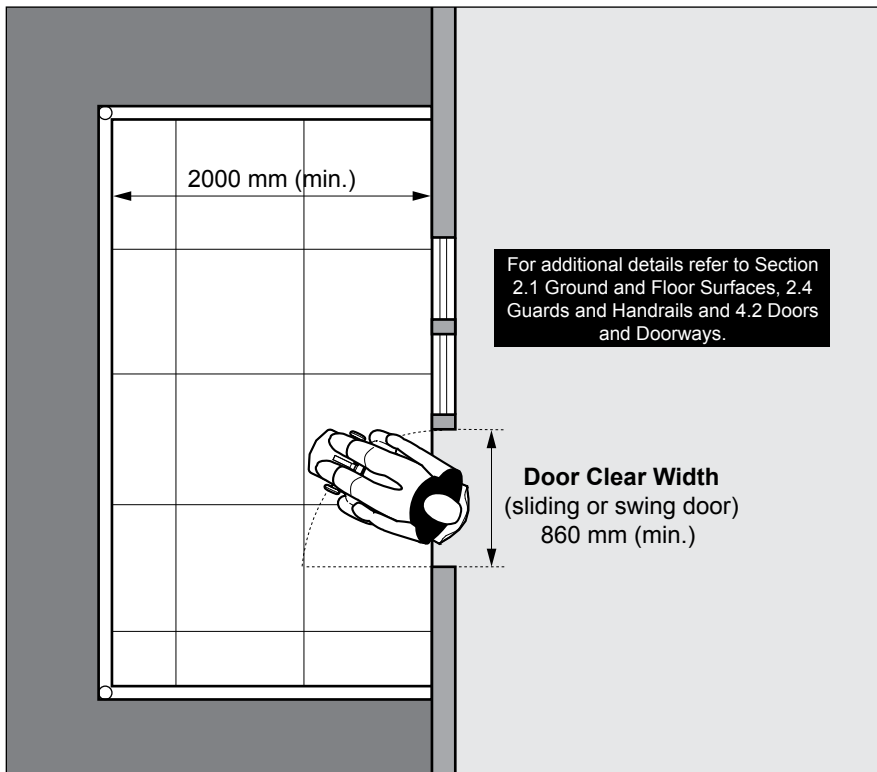

Figure 98: Balcony / Terrace - Plan View



6.10

Application

This section applies to service counters used by both the public and staff, whether the services are obtained in the buildings or outdoors. Service counters may include, but are not limited to:

- reception desks;
- check-out counters;
- teller counters;
- security counters;
- information desks or kiosks; and
- food service counters.

Reference

- Sec. 2.9 Public Telephones
- Sec. 2.10 Seating, Tables and Work Surfaces
- Sec. 4.3 Interior Accessible Routes
- Sec. 5.7 Lighting
- Sec. 5.8 Signage and Wayfinding

Note

A variety of service counter applications are provided in the built environment, with numerous options for accessible design.

6.10.1 Provision

- where a single queuing line serves a single or multiple counters, ensure each service counter is accessible; or
- where there are multiple queuing lines and service counters, ensure at least one (1) service counter is accessible for each type of service provided.

6.10.2 Design and Layout

- locate on an accessible path of travel;
- where there are multiple queuing lines and service counters, provide signage (e.g., International Symbol of Accessibility) to identify the accessible service counter(s),
- provide clear floor space in front of service counters for users of mobility aids (**Figure 101**):
 - 760 mm wide by 1370 mm deep to allow forward approach; and
 - 1525 mm wide by 915 mm deep to allow side approach;
- ensure service counter surface provides a high tonal contrast compared with adjacent surfaces to identify counter when approaching;
- provide lighting in accordance with Section 5.7 Lighting requirements, as applicable; and
- provide a lowered counter usable from seated position:
 - with top surface mounted between 730 mm and 865 mm high above floor;
 - ensure a clear knee space under the counter of at least 480 mm deep by 760 mm wide by 685 mm high (**Figure 100**); and
 - ensure maximum forward reach of 635 mm deep across top.

Best Practice

Ensure sources of light (natural or artificial) are not positioned directly behind service counters as they place people in silhouettes, which is a problem for people who lip read and people with vision loss.

Where service counters are accessible on both sides for public and staff use, width of counter surface should allow seating positions to be diagonal from each other to allow suitable reach across counter for transactions.

Ensure accessible service counters are not used as storage space.

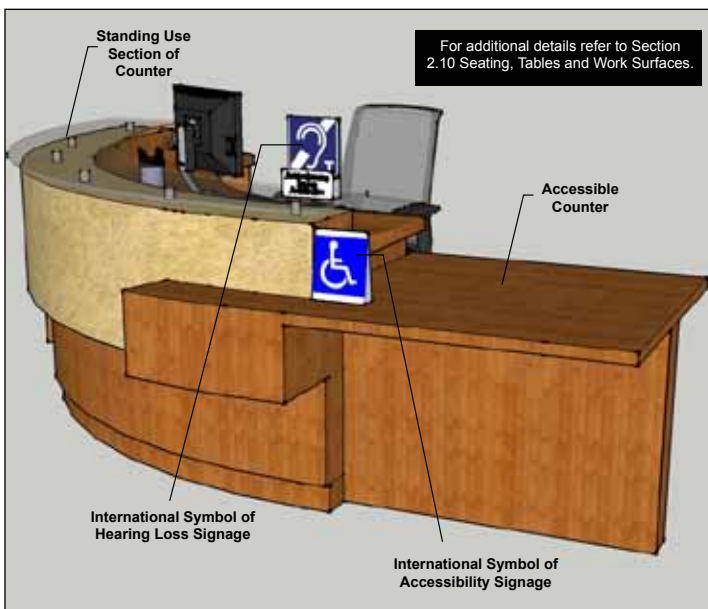

Figure 99: Example of Typical Service Counter



Figure 100: Dimensions of Accessible Service Counter

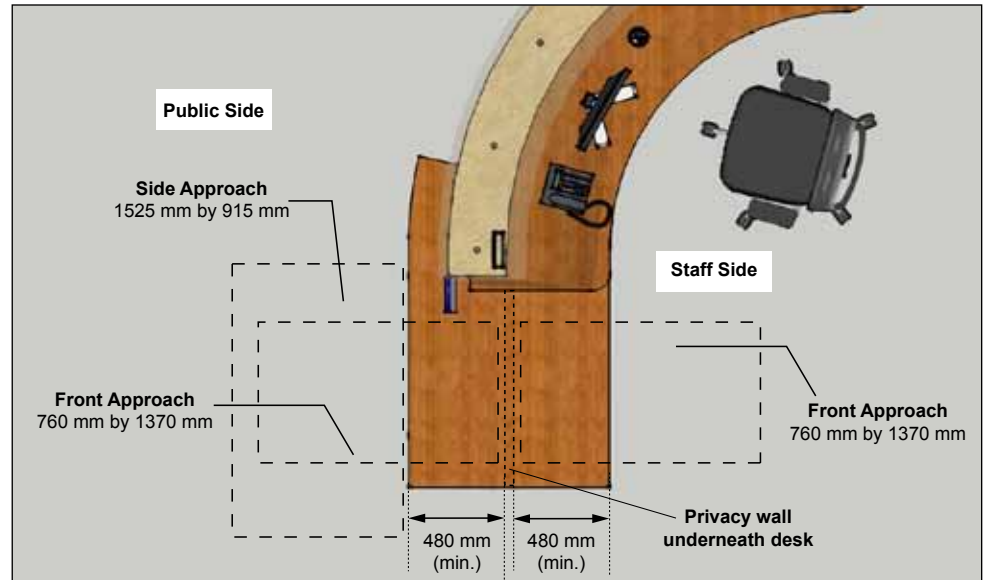

Figure 101: Clear Floor Space Requirement at Accessible Service Counter - Plan View

Best Practice

Provide disability awareness / sensitivity training for staff where communication systems are provided to ensure proper use and interaction with customers with disabilities.

6.10.3 Communication Systems

Where communication systems are provided at service counters:

- ensure counter areas are well-lit to assist staff and visitors with hearing loss who may communicate by lip reading;
- where speaking ports are provided, provide at least one speaking port at 1000 mm high (maximum) from floor level;
- where no staff person is available, provide an information phone or call bell with information signage, with controls mounted at 1100 mm (maximum);
- integrate TTY service or alternate devices for visitors who are Deaf, deafened or hard of hearing;
- where assistive listening systems are available, ensure signage with International Symbol for Hearing Loss is provided to indicate devices are available for use; and
- where staff communicate from an enclosed counter behind glass, ensure the glazing does not reflect glare. Where appropriate install sliding windows that open fully to allow communication, whether verbal, through lip reading or use of sign language.

6.10.4 Additional Resources

- Ministry of Community and Social Services: Accessible Standards for Customer Service: www.mcsc.gov.on.ca/en/mcsc/programs/accessibility/customerservice/
- Toronto Association of Business Improvement Areas "Missed Business": www.toronto-bia.com/resources/accessibility/Missed_Business.pdf



Waiting and Queuing Areas

6.11

Application

This section applies to waiting and queuing areas in both interior and exterior environments.

Reference

- Sec. 2.10 Seating, Tables and Work Surfaces
- Sec. 4.1 Entrances
- Sec. 4.3 Interior Accessible Routes
- Sec. 5.8 Signage and Wayfinding
- Sec. 6.1 Assembly Areas
- Sec. 6.10 Service Counters

Best Practice

Provide companion seating immediately adjacent to the accessible seating.

Provide tactile floor plan / directional map to assist users with vision loss with wayfinding throughout complex facilities.

Provide a range of seating options such as wider seats.

Note

Clear floor space for designated accessible seating must be positioned to allow shoulder alignment for user of mobility aid and person in adjacent seat.

6.11.1 Waiting Areas

Where waiting areas are provided:

- position the waiting area so that it is clearly visible when entering the facility;
- provide directional and informational signage to identify and guide users to waiting areas, where they may not be clearly visible when entering a facility;
- ensure a lowered counter with suitable knee clearance for users of mobility aids is provided, where there is a counter;
- where fixed seating is provided, ensure at least 3% of the seating is accessible but in no case fewer than one accessible seating space:
- where accessible seating is provided:
 - provide a clear floor space of 915 mm wide and 1400 mm depth, adjacent to fixed seating / waiting area and away from the main path of travel, for users of mobility aids to position themselves, their equipment, a service animal, or maneuver throughout the space (**Figure 102**);
 - locate adjacent and connected to an accessible path of travel; and
 - provide variety of seating options, including back and arm supports for various users; and
 - ensure accessible seating is integrated with the overall layout of other seating that is provided in waiting areas;
- provide a building directory for large facilities, especially where no rooms are assigned; and
- where lower coffee or telephone tables are provided adjacent to seating / waiting areas, ensure the top surface is 510 mm high (minimum), for reach from a seated position.

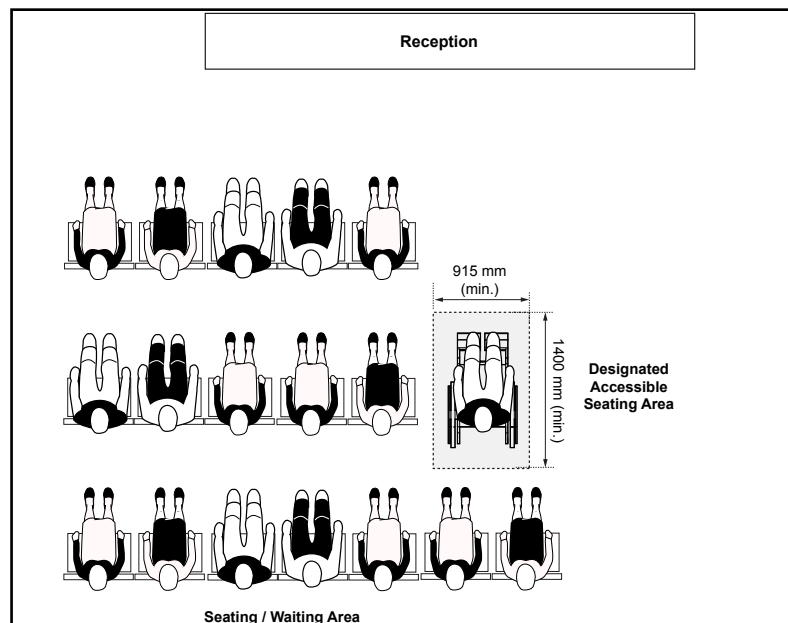

Figure 102: Waiting Area - Plan View

Best Practice

Provide clear floor space of 1800 mm by 1800 mm at entry, exit and turn locations to accommodate larger wheelchairs and scooters.

Consider including rest areas with accessible seating along the queuing system, where queues are longer than 10 metres. Additionally, provide a rest area at the end of the queuing system for people to wait for companions who are queuing.

Note

Rope or flexible banding is not recommended for permanent queuing systems because they are more difficult to detect with a long cane and are unstable. When temporary queuing guides are provided, ensure they are cane detectable and stable.

6.11.2 Queuing Areas

Where queuing areas are provided:

- locate on an accessible path of travel; and
- provide directional and informational signage to identify location of queuing area entry.

6.11.2.1 Fixed Queuing Guides

When providing fixed queuing guides:

- ensure clear width of 1100 mm (minimum) between guides (**Figure 103**);
- provide clear floor space of 1675 mm wide by 1675 mm deep (minimum), where queuing guides change direction and where they begin and end;
- ensure lower edge or base guides are cane-detectable, mounted at or below 680 mm from floor, with supports;
- provide a high tonal contrast between guide surfaces and adjacent surroundings (e.g., for enhanced visibility); and
- ensure guides have a glare-free finish.

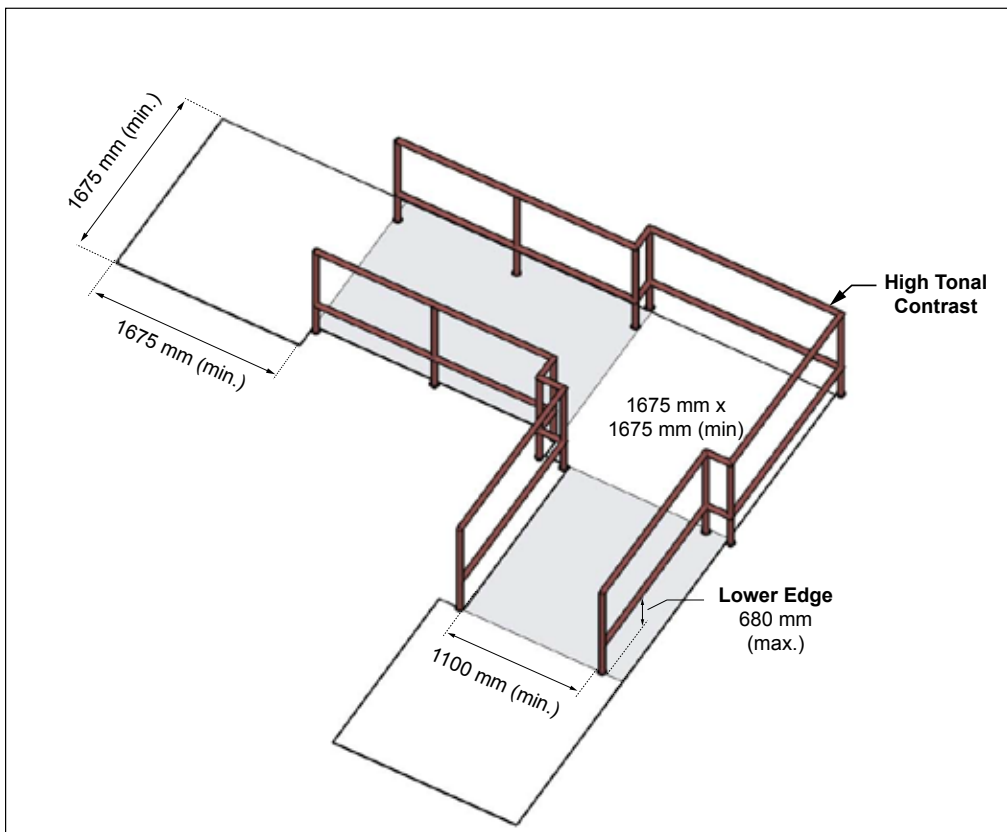



Figure 103: Fixed Queuing Guides



Elevated Platforms or Stages

6.12

Application

This section applies to elevated platforms or stages for both interior and exterior environments. Stages are typically provided in auditoriums, theatres and lecture halls used for performances and presentations.

Reference

- Sec. 2.2 Ramps
- Sec. 2.3 Stairs
- Sec. 2.4 Guards and Handrails
- Sec. 2.7 Tactile Walking Surface Indicators
- Sec. 5.2 Assistive Listening Systems

Best Practice

Providing both stair and ramp access increases the flexibility for the use of stages by people with varying disabilities.

Note

Other considerations may include accessibility features for podiums and electronic equipment (e.g., microphone systems), that are provided.

6.12.1 Design and Layout

- locate on an accessible path of travel;
- ensure at least one accessible route is provided to both audience seating and backstage areas for public or staff use via a sloped walkway (preferred), ramp or lift;
- where stairs and steps are included in the design, ensure handrails and edge protection are provided as required;
- provide lighting in accordance with Section 5.7 Lighting requirements, as applicable, including provision of secondary task lighting sources that can be used as required; and
- provide tactile walking surface indicators (TWSI):
 - 610 mm from edge of elevated platform or stage, extending full length (Figure 104); and
 - depth of 610 mm (minimum).

Best Practice

Lighting level of 200 lux (20 foot-candles) is recommended. This is beneficial for users who lip read or use Sign Language Interpretation.

Provide space for sign language interpreters and captioning on stages.

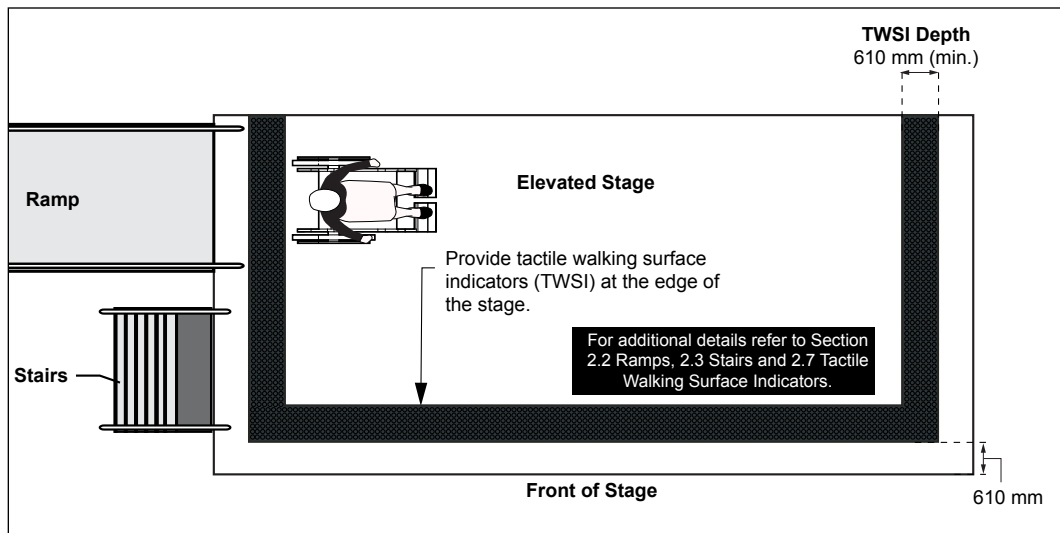

Figure 104: Elevated Platform or Stage - Plan View



6.13

Application

This section applies to the construction of affordable rental housing in buildings of 24 or more units that are funded by the City of Ottawa.

For the private sector, visitability is encouraged for the construction and/or substantial renovation of residential housing units.

Additional visitability standards may be required within Requests for Proposals (RFP's) that are issued by the Housing Services Branch to develop new affordable housing.

Exception

This section does not apply to ongoing maintenance and repair to existing public social or affordable housing.

6.13.1 What is Visitability?

Visitability refers to a design strategy that aims to provide basic access to a home through three key design elements:

- Level entry and clear space at entrance area;
- Wider doors and accessible routes throughout the entrance level; and
- A washroom on the same level as the accessible entrance.

Visitability does not refer to the creation of barrier-free / fully accessible units, but rather, it provides considerations for basic access and adaptability. Through the use of minimal adjustments, visitable housing makes communities more livable for people with physical disabilities, those who use mobility aids, and seniors by providing options to age in place.

6.13.2 Design Requirements

Key design features for visitable housing are summarized as follows:

6.13.2.1 Exterior Path of Travel

- a. ensure minimum clear width of 920 mm wide (1200 mm or greater is preferred); and
- b. provide a gentle grade (maximum 1:20 or 5%) from the street, sidewalk, back lane, or the dwelling unit's parking space leading to an accessible entrance into the dwelling unit.

6.13.2.2 Entrance and Landing Area

- a. provide a minimum clear area of 1525 mm by 1525 mm at entrance landing;
- b. ensure there is no step or elevation change at entrance;
- c. provide a no or low profile threshold at entrance; and
- d. ensure that the entry into a visitable unit is through the main entrance to the unit. Where this is not possible, an alternative entrance may be used, including an entrance located at the side, rear or through the garage of the home.

6.13.2.3 Interior Circulation

- a. provide doorways with a clear width of 860 mm (minimum); and
- b. ensure clear passage is provided throughout main floor corridors (on the same level as main entrance), with no elevation changes, with a minimum clear width of 920 mm (1200 mm is preferred) allowing access to all main floor activity areas, including the washroom.

6.13.2.4 Washroom

Ensure a washroom is located on the main or ground floor level with the following features:

- a. contain a minimum of one sink and one toilet;
- b. entrance door swings outward or is sliding;
- c. ensure clear floor space of 760 mm by 1220 mm is provided, clear of any door swing; and
- d. provide a clear route to the toilet 920 mm wide (minimum).

6.13.3 Recommended Visitability Features

- a. Doorways with a clear width of 920 mm.
- b. For doors at entrance and throughout main floor level, hardware such as handles, pulls, latches and locks that are operable with one hand and mounted no higher than 900 mm from finished floor. Operation of door hardware should not require fine manual dexterity, such as grasping, pinching or twisting. Return lever-type door opening hardware is recommended.
- c. At main entrance, provide electrical rough-in on the hinge side for the option of installing a power door operator in the future.
- d. Latch-side clearance of 600 mm on the pull side and 300 mm on the push side at entrance and interior doors.
- e. Door bell / intercom system operating controls mounted at 1200 mm.
- f. Raised electrical outlets mounted at 455 mm (minimum) to centre line above finished floor level.
- g. For the main floor washroom:
 - i. provide a minimum of one suitably mounted grab bar and wall reinforcement for future grab bar installation; and
 - ii. provide lever type faucet controls and non-slip flooring.
- h. For the kitchen:
 - i. provide lever type control at sink;
 - ii. ensure clear floor space of 765 mm by 1200 mm (minimum) in front of each appliance, sink and work counters; and
 - iii. provide a minimum clearance between counters and all opposing cabinets of 1500 mm (minimum).



6.14

Application

This section applies to newly constructed and redeveloped outdoor public use eating areas at public facilities, which typically provide tables (e.g., picnic tables) intended for public use as a place to consume food.

Reference

- Sec. 2.6 Rest Area
- Sec. 2.10 Seating, Tables and Work Surfaces
- Sec. 3.3 Exterior Paths of Travel
- Sec. 4.5 Washrooms

Best Practice

Disperse the locations of accessible tables in outdoor public use eating areas to provide a choice for users with disabilities.

Consider fixing accessible tables and seating so that they cannot be moved to an inaccessible location.

6.14.1 Design and Layout

- ensure a minimum of twenty percent (20%) of tables and no fewer than one (1) in outdoor public use eating area are accessible;
- ensure accessible tables provide suitable knee and toe clearances (**Figure 105b**);
- provide a clear space of 2000 mm (minimum) on all sides of the table (**Figure 105a**);
- locate on an accessible path of travel or trail;
- ensure ground surface leading to and under tables is firm, stable and no steeper than 1:50 (2%);
- provide directional signage at strategic locations to identify the location(s) of accessible tables and or public use eating areas;
- where barbecues are provided in outdoor public use eating areas, ensure they are placed away from the accessible path of travel and on a surface with high tonal and textural contrast with the adjacent surfaces; and
- where washrooms are provided, ensure accessible features (e.g., at least one universal toilet room, per cluster of regular washrooms).

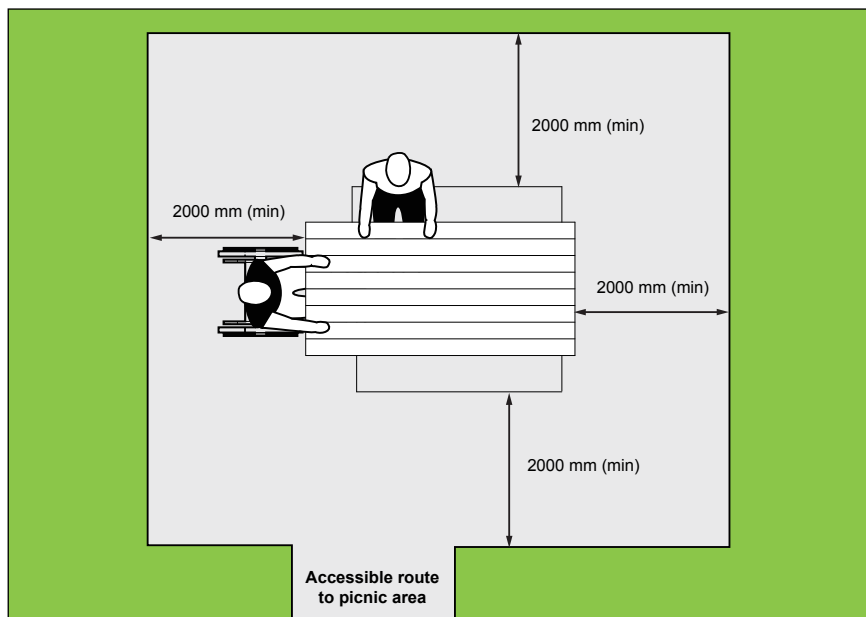

Figure 105a: Picnic Table Design and Features - Plan View

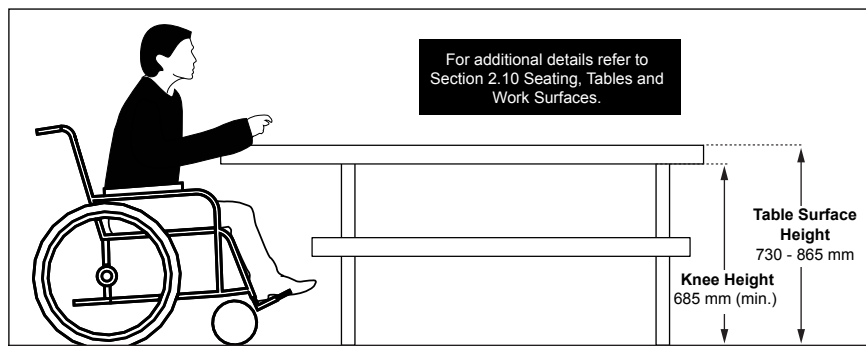

Figure 105b: Picnic Table Design and Features - Elevation View



Recreational Trails, Beach Access Routes and Boardwalks

6.15

Application

This section applies to:

- newly constructed and redeveloped recreational trails that the City intends to maintain, but it does not apply to trails solely intended for cross-country skiing, mountain biking or the use of motorized snow vehicles or off-road vehicles, wilderness trails, backcountry trails and portage routes;
- newly constructed and redeveloped beach access routes that the City intends to maintain, including permanent and temporary routes that are established through the use of manufactured goods, which can be removed for the winter months; and
- boardwalks that are part of newly constructed or redeveloped recreational trails and beach access routes that the City intends to maintain.

Reference

- Sec. 2.1 Ground and Floor Surfaces
- Sec. 2.2 Ramps
- Sec. 2.4 Guards and Handrails
- Sec. 2.5 Overhanging and Protruding Objects
- Sec. 2.6 Rest Areas
- Sec. 2.10 Seating, Tables and Work Surfaces
- Sec. 3.3 Exterior Paths of Travel
- Sec. 5.8 Signage and Wayfinding
- Sec. 6.14 Outdoor Public Use Eating Areas

Note

Trails are not considered the same as exterior routes, paths and walkways. Trails do not include pathways such as public sidewalks or pathways between buildings.

Best Practice

Trails with options for entry and exit at multiple trailheads typically can enhance accessibility when requirements of this section are integrated.

Note

A trailhead is a designated point of access that may contain a parking area, information kiosks, information signage, rest areas, washrooms, water fountains or other user amenities, which are typically reached by vehicular or pedestrian access.

6.15.1 Recreational Trails

6.15.1.1 Consultation Requirements

Before constructing new or redeveloping existing recreational trails, the City will consult with the Accessibility Advisory Committee, the public, and persons with disabilities on:

- a. the slope of the trail and;
- b. the need for, and location of, ramps on the trail; and
- c. the need for, location and design of,
 - i. rest areas;
 - ii. passing areas;
 - iii. viewing areas;
 - iv. amenities on the trail; and
 - v. any other pertinent feature.

6.15.1.2 Designated Trailheads

- a. ensure designated trailheads with information signage are integrated as part of the trail design, at key entrance and exit points along the trail, intermediate areas on lengthy trails or decision points (e.g., changes in elevation or where there is option to go in multiple directions) where required. Typically, a case by case review and analysis is required, based on trail type, location and other conditions (**Figure 106**).



Figure 106: Example of Trail with Multiple Trailhead Options

6.15.1.3 Trail Entrance / Exit Points

- a. provide 850 mm to 1000 mm clear opening whether entrance includes a gate, bollard or other entrance design; and
- b. ensure entrances are maintained and clear of obstructions that can reduce the clear width of the entrance.

6.15.1.4 Trail Clear Width

- provide clear width of 1000 mm (minimum) to 1800 mm (preferred);
- where the clear width is less than 1800 mm, provide a passing space of 1800 mm wide by 1800 mm (minimum) long, at intervals no more than 30 m (**Figure 107**);
- ensure headroom clearance is 2100 mm (minimum) above the trail; and
- ensure no obstructions or projections along trail.

Note

Where trail width is minimal, ensure this occurs for the shortest distance possible.

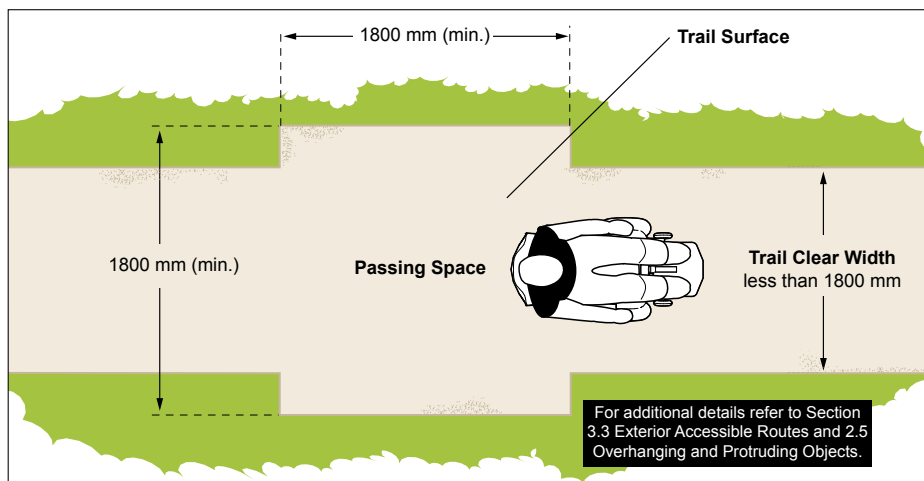

Figure 107: Trail Clear Width

6.15.1.5 Trail Surfaces

- ensure surface is firm and stable;
- ensure that openings must not allow passage of an object that has a diameter of more than 20 mm (13 mm diameter preferred), and that any elongated openings are oriented approximately perpendicular to the direction of travel;
- ensure resistance to damage by normal weather conditions, with ability to sustain typical wear and tear between planned maintenance cycles; and
- ensure type of surface used and expected conditions that may change over time are identified in information signage provided at trailhead.

Best Practice

Where running or cross slopes exceed 1:20 (5%), provide level rest areas, 1800 mm by 1800 mm (minimum), every 30 m.

6.15.1.6 Trail Running and Cross Slopes

- provide a running slope that is as gentle as possible, as permitted by the terrain, to minimize amount of strength and stamina required to use the trail; and
- ensure cross slopes are as gentle as possible, as permitted by the terrain, to provide an even surface for diverse users, including people using mobility aids or have difficulty with balance.

Note

For detailed guidance on trail surface design and slope requirements for unique conditions, refer to “Ontario’s Best Trails Guidelines and Best Practices for the Design Construction and Maintenance of Sustainable Trails for All Ontarians” resource document.

Note

Colour, texture and tonal contrast can be integrated to assist users with identification of edge protection.

Exception

Where there is a protective barrier that runs along the edge of a recreational trail that is adjacent to water or a drop-off, edge protection does not have to be provided.

Best Practice

Existing trails for which information has not been developed should be marked (e.g., temporary site signage) to indicate that the information is not yet available and the expected date it will be available.

Use multiple communication strategies to provide trail information, including on site (e.g., maps, trailhead kiosk or vertical signage), in alternate formats at key City locations, and online (e.g., City website or trail related websites, such as "Trail Explorer", www.trailexplorer.org).

6.15.1.7 Ramps

Where ramps are provided on trails:

- provide running slope no greater than 1:10 (10%); and
- with the exception of running slope, ensure compliance with ramp requirements from Section 2.2 and elsewhere in this document.

6.15.1.8 Edge Protection

Where recreational trails are constructed adjacent to water or a drop-off, provide edge protection with the following requirements:

- constitute of an elevated barrier that runs along the edge the recreational trail to prevent users from slipping over the edge;
- have the top of the edge protection at 50 mm (minimum) high above the trail surface; and
- be designed so as not to impede the drainage of the trail surface.



Example of protective barrier where there is a large elevation change or trail is adjacent to water feature.

6.15.1.9 Trailhead Signage

- For each trailhead along recreational trails, provide signage with the following information (**Figure 108**):
 - the length of the trail
 - the type of surface of which the trail is constructed;
 - average and minimum trail width;
 - average and maximum running and cross-slopes;
 - the location of features and amenities, where provided;
 - extreme or unique conditions (e.g., steep slopes, obstacles or narrow widths); and
- ensure signage text has high tonal contrast with its background in order to assist with visual recognition, with text that includes characters that use a sans serif font.

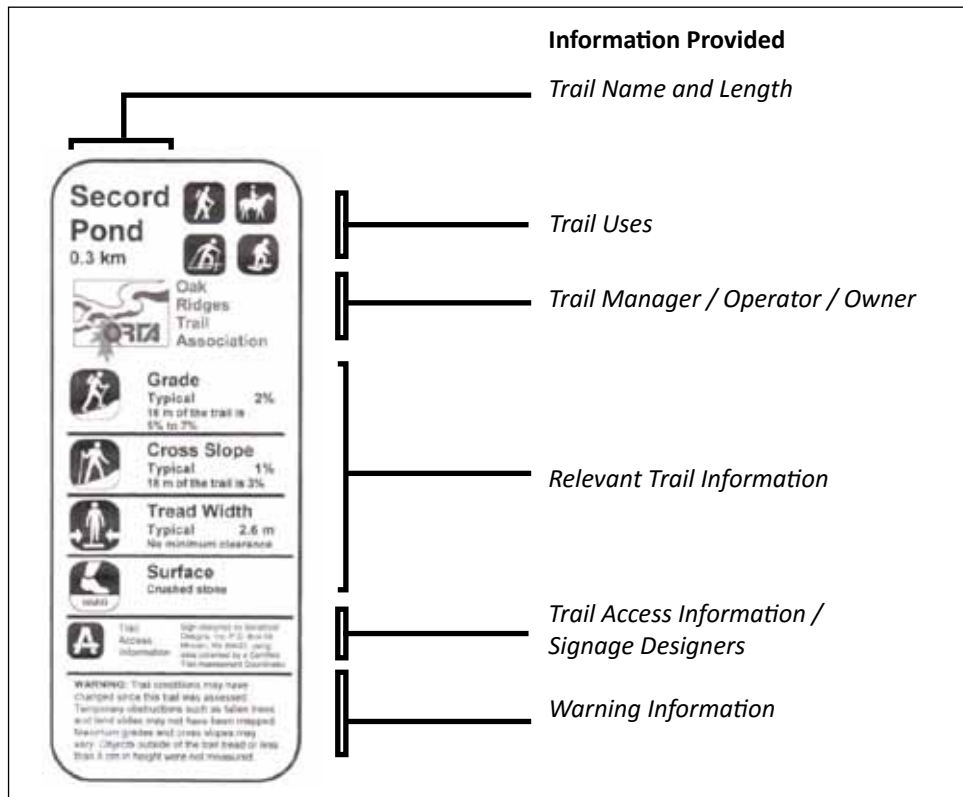

Figure 108: Example of Typical Universal Trail Assessment Process (UTAP) Signage

Best Practice

Provide contact information at trailheads where the public can report any damages, safety hazards or vandalism on the trail.

Note

The information provided must be objective to allow users with or without disabilities to make an informed decision before using a trail. This recognizes varied conditions in trail environments but it also encourages the maximum use of trails.

6.15.1.10 Other Media

- where other media such as park websites or brochures are used to provide information about the recreational trail, beyond advertising, notice or promotion, provide the same information identified on the trailhead signage.

6.15.1.11 Understanding the Universal Trail Assessment Process (UTAP)

The UTAP was developed by Beneficial Designs Inc. and is considered an objective method of documenting trail conditions and evaluating trails accessibility levels.

The UTAP method relies on systematically evaluating trail measurements and data collected by auditors. Auditors begin at a station point (e.g., trailhead) and mark subsequent station points along the trail, which define trail segments. Typically, station points occur where there is a change in the trail characteristics, such as at the beginning / end of a slope, at an intersection, or at a major feature. For each trail segment, key measurements (e.g., running slope, cross slope, surface, width and length of trail) are gathered using the “Segment Data Collection Sheet”.

After collection, the data is entered into the “Trailware” software, which formally evaluates the data based on the UTAP methodology and generates a Trail Access Information (TAI) report. This report can then be used to provide trail accessibility information to all users.

Best Practice

Trail accessibility features should be assessed using the Universal Trail Assessment Process (UTAP).

6.15.1.12 Additional Resources

- Ontario's Best Trails: www.ontariotrails.on.ca
- Trail Explorer: www.trailexplorer.org
- Universal Trail Assessment Process (UTAP): <http://www.beneficialdesigns.com/services/trails-shared-use-path-assessments/the-universal-trail-assessment-process-utap>

6.15.2 Beach Access Routes

6.15.2.1 Entrances

- a. provide 1000 mm clear opening whether entrance includes a gate, bollard or other entrance design.

6.15.2.2 Clear Width

- a. provide clear width of 1000 mm (minimum); and
- b. provide headroom clearance of 2100 mm (minimum) above beach access route.

6.15.2.3 Surfaces

- a. ensure surface is firm and stable;
- b. ensure that openings must not allow passage of an object that has a diameter greater than 13 mm and that any elongated openings are oriented approximately perpendicular to the direction of travel; and
- c. where the surface of the route is constructed (e.g., not natural):
 - i. ensure surface has 1:2 bevel at changes in level between 6 mm and 13 mm;
 - ii. provide a maximum running slope of 1:10 (10%) at changes in level between 14 mm and 200 mm; and
 - iii. provide a ramp where changes in level are greater than 200 mm.

6.15.2.4 Running and Cross Slopes

- a. ensure the running slope is 1:10 (10%) (maximum);
- b. ensure the cross slope is 1:50 (2%) (maximum), where the surface area of the beach access route is constructed (e.g., not natural); and
- c. where surface area is not constructed, ensure the maximum cross slope is the minimum slope required for drainage.

6.15.2.5 Ramps

Where ramps are provided on beach access routes:

- a. provide running slope no greater than 1:10 (10%); and
- b. with the exception of running slope, ensure compliance with ramp requirements from Section 2.2 and elsewhere in this document.

6.15.3 Boardwalks

Where a recreational trail or beach access route is equipped with a boardwalk, apply the following requirements.

6.15.3.1 Clear Width

- a. provide clear width of 1000 mm (minimum);
- b. where the clear width is less than 1800 mm, provide a passing space of 1800 mm wide by 1800 mm (minimum) long, at intervals no more than 30 m; and
- c. ensure headroom clearance is 2100 mm (minimum) above the boardwalk.

6.15.3.2 Surfaces

- a. ensure surface is firm and stable; and
- b. ensure that openings must not allow passage of an object that has a diameter of more than 20 mm (13 mm diameter preferred), in any direction and that any elongated openings are oriented approximately perpendicular to the direction of travel.

6.15.3.3 Running and Cross Slopes

- a. ensure the running slope is 1:20 (5%) (maximum);
- b. where the running slope is steeper than 1:20 (5%), the running slope must meet the requirements for ramps identified in this section; and
- c. ensure the gradient of the cross slope is the minimum required for drainage.

6.15.3.4 Edge Protection

- a. provide edge protection that is 50 mm (minimum) high; and
- b. ensure the design allows suitable drainage of boardwalk surface.

Recreational Trail Design Checklist

6.16

Application

The information in this Checklist is intended to assist City Staff when reviewing key design options for providing accessible recreational trails for users of all ages and abilities.

A formal accessibility assessment of recreational trails, using the Universal Trail Assessment Process (UTAP), is recommended for existing recreational trails. The UTAP is considered an objective method of documenting trail conditions and evaluating accessibility levels for diverse users and is recognized as a current best practice.

Best Practice

The most significant barrier to trail accessibility is a lack of information about the recreational trail conditions. Providing such information will encourage participation and increase independence in trail use. Information on conditions affecting accessibility (e.g., grade, surface and obstacles) will also allow enhanced planning for assistance if required.

Note

Refer to Section 6.15 Recreational Trails, Beach Access Routes and Boardwalks, for detailed information on accessibility criteria for recreational trails and the UTAP.

Recreational Trail Design Checklist

The following checklist is intended for use by City Staff when reviewing key accessibility design options for new trails. Additional considerations are required for reviewing existing trails (e.g., applying the UTAP), recognizing the variety of trail types and environments that are available.

General Information

Reference (I.D # / Park Name): _____

Reviewed By

Name: _____

Title / Position: _____

Department: _____

1. Key Trail Features			
1.1 Trailhead			
1.1.1	Are there multiple TRAILHEADS to allow accessible entry and exit points along the trail? Identify number and location of trailheads.	<input type="checkbox"/> Y <input type="checkbox"/> N	Comments:
1.1.2(a)	Are EXTERIOR AMENITIES provided at trailheads (e.g., parking, accessible routes, public washrooms, etc.)? If yes, identify provisions and location of amenities	<input type="checkbox"/> Y <input type="checkbox"/> N	Comments:
1.1.2(b)	If provided, have the City's amenities been reviewed for compliance with relevant sections of the City of Ottawa Accessibility Design Standards?	<input type="checkbox"/> Y <input type="checkbox"/> N <input type="checkbox"/> N/A	Comments:
1.2 Trail Clear Width			
1.2.1	Is the CLEAR WIDTH of the trail at least 1000 mm (1800 mm preferred)? <i>Note:</i> Ensure placement of vegetation and permanent design features (e.g., bollards and decorative boulders) does not create obstruction or projection along accessible route.	<input type="checkbox"/> Y <input type="checkbox"/> N	Comments:
1.2.2	Where there are changes in level along the trail, are EDGE PROTECTION at least 50 mm high provided and edges clearly marked (e.g., colour and texture contrast) to assist identification?	<input type="checkbox"/> Y <input type="checkbox"/> N <input type="checkbox"/> N/A	Comments:
1.2.3	Is the HEADROOM CLEARANCE above the trail at least 2100 mm?	<input type="checkbox"/> Y <input type="checkbox"/> N <input type="checkbox"/> N/A	Comments:
1.3 Trail Slopes			
1.3.1	Is the RUNNING SLOPE as gentle as possible, as permitted by the terrain?	<input type="checkbox"/> Y <input type="checkbox"/> N	Comments:
1.3.2	Is the CROSS SLOPE as gentle as possible, as permitted by the terrain?	<input type="checkbox"/> Y <input type="checkbox"/> N	Comments:

1.4 Trail Surface			
1.4.1	Is the TRAIL SURFACE firm and stable? Identify type of surface and material used to meet accessibility requirements.	<input type="checkbox"/> Y <input type="checkbox"/> N	Comments:
2. Signage			
2.1(a)	Is there suitable TRAIL NAME / IDENTIFICATION SIGNAGE at trailheads and key access points, with accessibility features (e.g., large print, use of strong tonal contrast and pictograms) identifying amenities that may be available?	<input type="checkbox"/> Y <input type="checkbox"/> N	Comments:
2.1(b)	<p>If yes, does the signage include the following information:</p> <p style="text-align: center;">Trail Name</p> <p style="text-align: center;">Trail Map</p> <p style="text-align: center;">Trail Length</p> <p style="text-align: center;">Trail Surface Type</p> <p style="text-align: center;">Trail Running Slope (Grade)</p> <p style="text-align: center;">Trail Cross Slope</p> <p style="text-align: center;">Trail Manager / Operator</p> <p><u>Note:</u> Identifying this information in accessible format allows users of all ages and abilities to make an informed decision about using the trail. Refer to Section 6.15 Recreational Trails, Beach Access Routes and Boardwalks for more information on the UTAP.</p>	<input type="checkbox"/> Y <input type="checkbox"/> N <input type="checkbox"/> Y <input type="checkbox"/> N <input type="checkbox"/> Y <input type="checkbox"/> N <input type="checkbox"/> Y <input type="checkbox"/> N <input type="checkbox"/> Y <input type="checkbox"/> N <input type="checkbox"/> Y <input type="checkbox"/> N <input type="checkbox"/> Y <input type="checkbox"/> N	Comments:
2.2	Have any barriers to accessibility (e.g., steep slopes or difficult topography) along the trail been identified on signage at strategic locations? If yes, describe information to provide on signage.	<input type="checkbox"/> Y <input type="checkbox"/> N	Comments:
3. Additional Considerations			
3.1	<p>Does the trail reflect the varied needs of users, the varied natural landscape and the shared desire for varied trail experience?</p> <p><u>Note:</u> Design should incorporate both sustainable and universal design features to ensure the widest range of users can benefit.</p>	<input type="checkbox"/> Y <input type="checkbox"/> N	Comments:
3.2	Does the trail offer areas for rest and options for shorter or longer on-trail adventures so that trail users can choose the experience that most suit them?	<input type="checkbox"/> Y <input type="checkbox"/> N	Comments:
3.3	Is there a policy in place to address maintenance issues for trails designed for year-round use (e.g., removal of debris and obstructions on trail surfaces etc)?	<input type="checkbox"/> Y <input type="checkbox"/> N	Comments:
3.4	If reviewing the design of an existing trail and related environments, has the UTAP been implemented to address the needs of diverse trail users of all ages and abilities?	<input type="checkbox"/> Y <input type="checkbox"/> N	Comments:



6.17

Application

This section applies to play spaces designed for children. Play spaces can be located in a variety of public settings (e.g., parks, schools, childcare facilities or community / recreation centres). Play spaces typically require consideration for accessibility features related to:

- the number and types of play structures, equipment, elements and features provided;
- play areas surrounding the play structures; and
- site amenities and features surrounding the play space.

Criteria provided in this section is intended to summarize key features for inclusive play spaces and reference to applicable standards. Detailed planning and design is required for provision of inclusive play spaces.

Reference

- Sec. 2.3 Stairs
- Sec. 2.4 Guards and Handrails
- Sec. 2.8 Drinking Fountains
- Sec. 3.1 Parking
- Sec. 3.3 Exterior Paths of Travel
- Sec. 4.5 Washrooms

Note

Inclusive play spaces ensure that children with disabilities have equal opportunities for peer interaction and development of socialization skills. They also provide an opportunity for parents with disabilities to interact with their children.

Note

Requirements related to the area surrounding or beyond the play space, including, but not limited to, parking lots, washrooms, drinking fountains, and recreation facilities, are referenced elsewhere in this document

6.17.1 Consultation Requirements

When constructing new or redeveloping existing outdoor play spaces, consultation on the needs of children and caregivers with various disabilities must occur with:

- a. the public and persons with disabilities; and
- b. the City of Ottawa Accessibility Advisory Committee.

6.17.2 Design Requirements

When constructing new or redeveloping existing play spaces:

- a. incorporate accessibility features, such as sensory and active play components, for children and caregivers with various disabilities into the design of outdoor play spaces; and
- b. ensure that outdoor play spaces have ground surface that is firm, stable and has impact attenuating properties for injury prevention and sufficient clearance to provide children and caregivers with various disabilities the ability to move through, in and around the outdoor play space.

Ensure the design of inclusive play spaces and features meet the requirements of CAN / CSA Z614-14, Annex H, including:

- i. H.1 Scope;
- ii. H.2 Reference Publications;
- iii. H.3 Reference Definitions;
- iv. H.4 Play spaces (e.g., ground-level and elevated play components, accessible routes, transfer systems, play components and ground surfaces); and
- v. other applicable sections of these Standards, as required.



Play spaces are typically designed for different age groups as they provide age-specific play components.

6.17.3 Summary of Key Design Considerations

The information in the following sub-sections is intended to highlight key considerations only, not detailed specifications. Refer to requirements of the Canadian Standards Association (CAN / CSA Z614-14, Annex H). This information is not intended to duplicate existing standards, but is focused on presenting best practices for accessibility.

Note

A level approach, gradually sloped route or ramps are examples of types of accessible entry / exit points to a play space.

6.17.4 Entry and Exit Points

Provide a minimum of two accessible ingress / egress points:

- a. located as part of an adjacent accessible route;
- b. ensure accessible connections provided to play space surfaces are firm, stable and slip-resistant, as well as providing direct connections to individual play components; and
- c. provide clear width of 1525 mm (minimum).



An example of accessible entry / exit point and accessible route leading to elevated play components.

6.17.5 Accessible Routes

- a. provide at least one accessible route within the boundary of the play space, connecting ground-level play components and elevated play components, including entry and exit points of the play components;
- b. ensure clear width of accessible route is 1525 mm (minimum); and
- c. ensure the maximum slope for an accessible route connecting ground-level play components within the boundary of a play space is 1:16 (6.25%).

Note

Refer to exceptions and detailed requirements, including gradient, clear width and reduced width criteria, identified in CSA, Annex H.

6.17.6 Play space Ground Surface

- a. provide accessible surface materials for play spaces such as poured-in-place rubber, accessible turf, rubber mats and tiles, bonded and engineered wood fibers or shredded rubber.



Examples of inclusive play space ground surfaces. From left to right: poured-in-place rubber, engineered wood fibre and shredded rubber.

6.17.7 Play Components

- a. provide a high tonal contrast between a play component and its surroundings.

6.17.8 Elevated Play Components

An elevated play component is a play component reached from above or below grade, and is part of a composite play structure.

- a. ensure at least 50% of elevated play components are connected to a ramp or transfer system, as identified in **Table 13**.

Table 13: Percentage of Elevated Play Components Required to be Connected to Transfer Systems

Total Number of Elevated Play Components	Total Percentage of Elevated Play Components Requiring Ramp or Transfer System
20 or more	50% minimum (25% ramp and 25% ramp or transfer system)
Less than 20	50% minimum (ramp or transfer system)



Examples of elevated play components.

6.17.9 Transfer Systems

- a. provide transfer systems to connect elevated or ground-level play components (e.g., transfer steps or platforms);
- b. ensure transfer steps are used where movement is intended from a transfer platform to a level that provides elevated play components on an accessible route; and
- c. provide a minimum clear floor space of 915 mm wide by 1370 mm long adjacent to all transfer locations onto play components (**Figure 109**).

Best Practice

The distance covered by the transfer steps should be the shortest possible.

Note

A transfer platform is used where transfer is intended from a wheelchair or other mobility aid. Refer to detailed requirements, including means of support and, surface sizes for example, identified in CSA, Annex H.

Examples of supports include a rope loop, a loop-type handle, a slot in the edge of a flat horizontal or vertical member, poles or bars, or solid D-shaped rings affixed to corner posts.

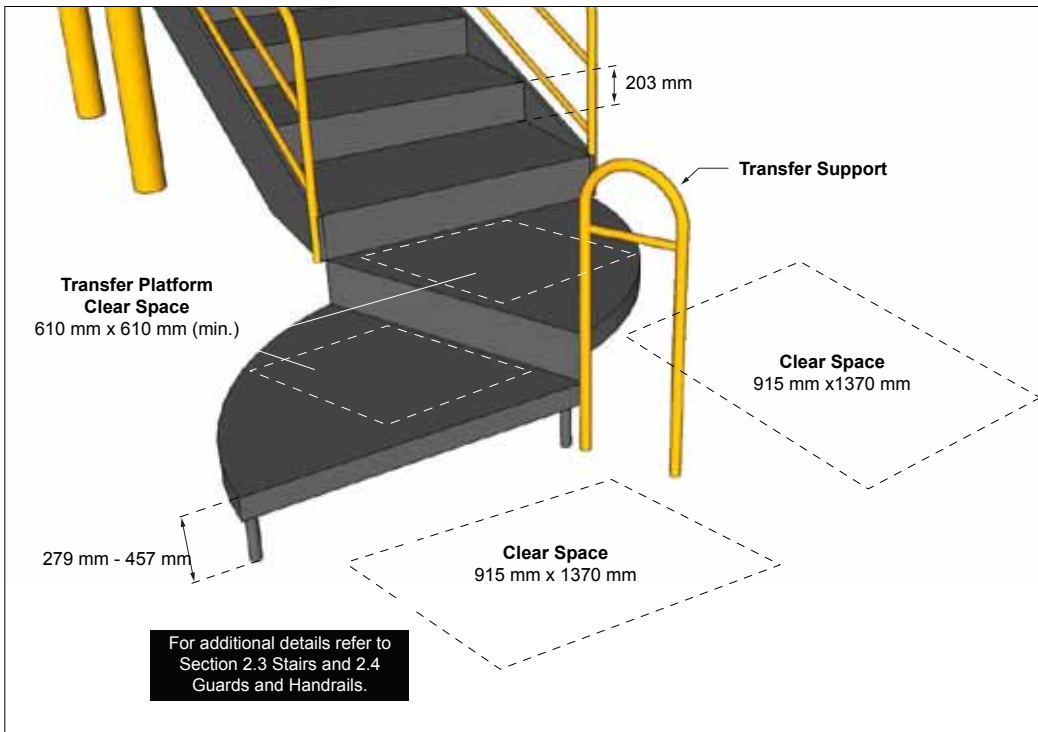

Figure 109: Transfer Systems

6.17.10 Turning Space

- a. provide clear turning space for mobility aids of 1675 mm (preferred) or 1500 mm (minimum) diameter on the same level as play components.

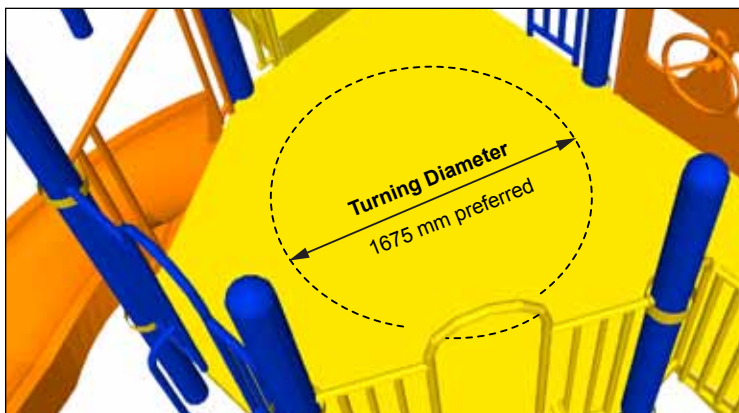

Figure 110: Turning Space - Plan View

6.17.11 Ground-Level Play Components

A ground-level play component is a play component that is approached and exited at the ground level. Provide the ratio of ground-level play component alternatives, compared to elevated play components, as identified in **Table 14**.

Table 14: Ground-Level Play Component Alternatives to Elevated Play Components

Number of Elevated Play Components provided	Minimum number of ground-level play components required to be on an accessible route	Minimum number of different types of ground-level play components required to be on accessible route
1	n/a	n/a
2 to 4	1	1
5 to 7	2	2
8 to 10	3	3
11 to 13	4	3
14 to 16	5	3
17 to 19	6	3
20 to 22	7	4
23 to 25	8	4
More than 25	8 plus 1 for each additional 3 over 25, or fraction thereof	5

Source: Canadian Standards Association (CAN / CSA Z614-14, Annex H)



Examples of ground-level play components.

Inclusive Play Space Design Guide

6.18

Application

This design guide is provided for use by City Staff when designing new inclusive play spaces.

How to Use the Guide

The **Inclusive Play space Design Guide** identifies key design features for planning and designing an inclusive play space, with a focus on the main accessibility features that are required to meet the diverse needs of users of all ages and abilities, including children using the play space as well as caregivers and companions. Additional design considerations may also be required related to the broader play space context and environment, including requirements for the site and park where the play space is located (e.g., seating and viewing areas for parents or caregivers). Overall, this Guide is intended to welcome and address the needs of children, caregivers and users of all age and abilities, emphasizing opportunities for inclusive and shared play.

Reference

- Sec. 2.2 Ramps
- Sec. 2.3 Stairs
- Sec. 2.4 Guards and Handrails
- Sec. 2.8 Drinking Fountains
- Sec. 2.10 Seating, Tables and Work Surfaces
- Sec. 3.1 Parking
- Sec. 3.2 Passenger Loading Zones
- Sec. 3.3 Exterior Paths of Travel
- Sec. 4.5 Washrooms
- Sec. 5.7 Lighting

Note

This guide does not provide all requirements for designing an inclusive play space; only key requirements are provided. Refer to Section 6.17, Inclusive Play Spaces of these Standards and CAN / CSA Z614-14 (Annex H), for more details.

Designing an Inclusive Play Space

Key Features of an Inclusive Play Space

Play spaces that offer children of all abilities the opportunity to interact and play with each other are essential to promoting diversity and inclusion.

The following diagram identifies important best practices when designing an inclusive play space.

Key features are numbered on the diagram and described in this guide.

- 1 Accessible Routes
- 2 Entry / Exit Points
- 3 Ground Surfaces
- 4 Elevated Play Components
- 5 Ground-Level Play Components

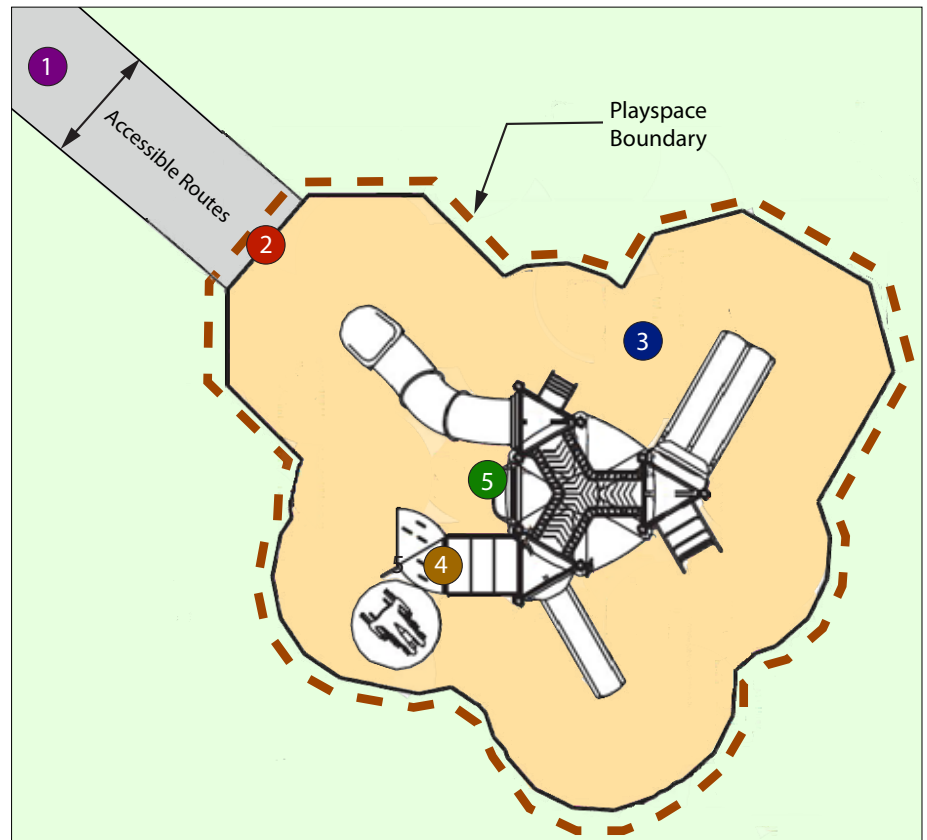

Diagram of Typical Play space Features

Note: Play spaces come in different shapes and sizes. This diagram is provided for guidance and reference only.

Summary of 5 Key Features

The following provides a summary of the 5 key design features when designing an inclusive play space.

1 Accessible Routes

Accessible route(s) connecting to the play space boundary from the parking lot, sidewalk and other adjacent routes and buildings are essential for easy access to the play space.

Key Consideration:

Is there at least one accessible route leading to the play space?



Accessible route connecting to play space.



Accessible route connecting to play space.

2 Entry / Exit Points

Entry / exit points from an accessible route along the boundary of the play space for users of mobility aids to access play components, where there is a change in level.

Key Consideration:

Is there at least one entry / exit point (2 or more preferred) into the play space?



Play space is at-grade with accessible route.



Curb ramp into play space where there is a level change between accessible route and play space.

3 Ground Surfaces

Surfacing is a key component in designing safe and accessible play spaces. **Accessible surfaces** include poured-in place rubber, shredded rubber and engineered wood fiber.

Key Consideration:

Is the play space ground surface accessible?



Shredded Rubber.



Engineered Wood Fiber.



Poured-in-Place Rubber.

4 Elevated Play Components

An **elevated play component** is a play component reached from above or below grade, and is part of a composite play structure.

Note: Ramps, transfer systems, steps, stand alone slides, decks and roofs are not considered elevated play components.

Two common methods for providing access to elevated play components are **ramps** and **transfer systems**.

Key Consideration:

Are at least 50% of elevated play components located on an accessible route and connected by a ramp or transfer system?



Example of play structure with elevated play components.



Example of play structure with elevated play components.



Ramp connected to elevated play components.



Transfer system to connect elevated play components.

5 Ground-Level Play Components

A **ground-level play component** is a play component that is approached and exited at ground level.

When designing an inclusive play space, one of the design features is the provision of play components along the accessible routes for users who may not be able to access components located on elevated platforms.

The number and variety of ground-level play components required to be on an accessible route is determined by the number of elevated play components provided in the play space.

Key Consideration:
Are the minimum number and variety of ground-level play components along an accessible route provided?

Note: A calculator to determine the required number and variety of ground-level and elevated play components required in an inclusive play space is provided in CAN / CSA Z614-14, (Annex H).



Example of a ground-level play component.



Example of an accessible swing.

STEP-BY-STEP GUIDE ON APPLYING ANNEX H

Step-by-Step Guide

The following step-by-step guide has been provided to assist in evaluating a playspace for meeting the minimum requirements of Annex H. The guide has been arranged in two steps and provides spaces to fill in numeric values of play components for evaluating a specific playspace design.

Step 1) Total # Of Elevated Play Components =

Assess Present Situation	
Total # Of Components Along Accessible Route (answer = item "A")	Variety Of Play Types Along Accessible Route (answer = item "X")
Assess What Is Needed (from Table H.1)	
Min. # Of Ground Level Components Required Along Accessible Route (answer = item "B")	Variety Of Different Play Types Required Along Accessible Route (answer = item "Y")
How To Get There	
Total # Of Components To Be Added (item "B" minus item "A")	Total Variety Of Play Types To Be Added (item "Y" minus item "X")

*A negative number in the either bottom box means that there is more than the minimum number already on site

Step 2) Assess Access to Elevated Components

Total # of Elevated Components =
<ul style="list-style-type: none"> • If 20 or more components then ramps to 25% and ramp or transfer to an additional 25% • If 19 or fewer components than transfer system or ramp to 50% of components

Courtesy of the Canadian Playground Safety Institute (cpsionline.ca) from the Online Accessibility Course.

Additional Considerations

Directions to be provided to play equipment supplier when selecting play equipment:

1. Provide age range and number of children using playspace;
2. Describe the vision for the proposed play space. Provide a Design Program which outlines the goals and objectives for the play space;
3. Describe the site context - what is around the play area and how it will be used;
4. Provide a budget for the equipment, keeping in mind costs for landscaping and natural features;
5. Follow CAN / CSA Z614-14, Annex H accessibility standards and Section 6.17 Inclusive Play Spaces; and
6. Emphasize equipment should fit into site plan, not vice versa.

Source: Adapted from "Let's Play: Creating Accessible Playspaces: A Tool Kit for School-Based Groups", Rick Hansen Foundation.

Inclusive Play Space Checklist

6.19

Application

The information in this Checklist is intended to assist with reviewing key design options for providing inclusive play spaces. Information in this checklist may be updated based on new design standards identified during implementation.

Use this Checklist when reviewing individual areas of each play space, depending on the overall layout, features and type of equipment that is provided.

Note

Refer to Sections 6.17 Inclusive Play Spaces and 6.18 Inclusive Play Space Design Guide and CAN / CSA Z614-14 (Annex H) for detailed information and accessibility criteria when designing a new inclusive play space.

Inclusive Play Space Checklist

The following checklist is intended for use by City Staff when reviewing key design options for inclusive play spaces. The items in this Checklist are colour coded to match the information in Section 6.18 Inclusive Play Space Design Guide.

General Information

Reference (Identification # / Park Name): _____

Play space Type: Junior Senior Adventure Combination Water Features

Identify Total Number of Play Areas or Zones _____

Reviewed By

Name: _____

Title / Position: _____

Department: _____

1. Key Design Consideration		
1.1 Accessible Routes		
1.1.1	Is there at least one (1) ACCESSIBLE ROUTE within the boundary of the play space?	<input type="checkbox"/> Y <input type="checkbox"/> N Comments:
1.2 Entry / Exit Points		
1.2.1	Is there at least one (1) ENTRY / EXIT POINT to the play space (2 or more preferred) connected to an accessible route?	<input type="checkbox"/> Y <input type="checkbox"/> N Comments:
1.3 Ground Surfaces		
1.3.1	Is the play space GROUND SURFACE accessible (specify surface type)? If yes, does ground surface material meet CSA standards for equipment and layout?	<input type="checkbox"/> Y <input type="checkbox"/> N Comments:
1.4 Elevated Play Components		
1.4.1	Are at least 50% of ELEVATED PLAY COMPONENTS located on an accessible route and connected by a RAMP or TRANSFER SYSTEM ?	<input type="checkbox"/> Y <input type="checkbox"/> N Comments:
1.5 Ground-Level Play Components		
1.5.1	Are the minimum number and variety of GROUND-LEVEL PLAY COMPONENTS required to be along an accessible route provided? <u>Note:</u> Use calculator identified in CAN / CSA Z614-14 (Annex H) to determine required number of play components.	<input type="checkbox"/> Y <input type="checkbox"/> N Comments:
2. Additional Considerations		
2.1	Are CREATIVE FEATURES that stimulate the senses provided (Examples include: water and sand features, scent gardens, wind chimes and winding pathways)? If yes, provide a description, including site context and amenities provided adjacent to play space or in the park.	<input type="checkbox"/> Y <input type="checkbox"/> N Comments:
2.2	Does play equipment foster inclusive play and allow children of all ages and abilities to be part of the action / activities? If yes, describe.	<input type="checkbox"/> Y <input type="checkbox"/> N Comments:
2.3	Does PLAY SPACE EQUIPMENT meet accessibility requirements of CAN / CSA Z614-14 (Annex H)? <u>Note:</u> A detailed assessment may be required.	<input type="checkbox"/> Y <input type="checkbox"/> N Comments:



6.20

Application

This section applies to the design of transit facilities, such as stations, platforms, stops, shelters, and other amenities designated as part of the public transit services that are operated by OC Transpo within the City of Ottawa.

Reference

- Sec. 2.1 Ground and Floor Surfaces
- Sec. 2.2 Ramps
- Sec. 2.3 Stairs
- Sec. 2.4 Guards and Handrails
- Sec. 2.6 Rest Area
- Sec. 2.7 Tactile Walking Surface Indicators
- Sec. 2.10 Seating, Tables and Work Surfaces
- Sec. 3.3 Exterior Paths of Travel
- Sec. 4.2 Doors and Doorways
- Sec. 4.4 Elevating Devices
- Sec. 5.1 Controls and Operating Mechanisms
- Sec. 5.7 Lighting
- Sec. 5.8 Signage and Wayfinding

Note

Where feasible, more stringent requirements can be used as required. Review of potential impacts is required with OC Transpo.

Best Practice

Where stations are more than one level, ensure that an alternate accessible route between levels is available to customers (e.g., by means of an additional elevator, ramp, pathway, etc.) in the event of an elevator outage or routine maintenance.

6.20.1 Station Requirements

6.20.1.1 General Station Requirements

- a. provide a firm, stable and slip-resistant surface;
- b. ensure a grade with no slope steeper than 1:50 (2%); and
- c. ensure shelters, street furniture and equipment, including benches, bus flags, garbage receptacles, bike racks, newspaper stands, etc. do not obstruct the accessible route.

6.20.1.2 Access to Buildings and Platforms

- a. ensure station buildings and platforms are interconnected to adjacent streets, sidewalks and pathways by an accessible route;
- b. provide at least one fully accessible route to each station platform (i.e. inbound and outbound platform); and
- c. ensure the slope of concrete platforms is uniform and where parallel to the Transitway, maintains the same slope and direction with a maximum average cross slope of 1:50 (2%).

6.20.1.3 Station Platforms

- a. provide a loading area for customers using mobility devices with a clear length of 2400 mm, measured perpendicular to the curb or vehicular route edge and a clear width of at least 1500 mm, measured parallel to the vehicular route;
- b. provide concrete with a stamped pattern placed in a recess, 610 to 650 mm in width and with a high tonal contrast with adjacent surfaces, along the front edge behind the steel facing for the full length of the platform;
- c. provide a tactile walking surface indicator, composed of truncated domes:
 - i. at curb ramps;
 - ii. at an entry into a vehicular route or area where no curbs, or other elements separate it from the pedestrian route of travel such as traffic islands and pedestrian crosswalks; and
 - iii. with minimum width of 610 to 650 mm across the full length of the drop-off;
- d. provide lighting in accordance with Section 5.7 Lighting requirements, as applicable, at all platforms; and
- e. provide a bench consistent with Section 2.10.1 Benches and Seats.

6.20.1.4 Station Shelters

- a. locate on a uniform precast / poured concrete pad;
- b. provide level access to the adjacent sidewalk, walkway or accessible route;
- c. ensure a clear unobstructed view of oncoming traffic;
- d. provide an unobstructed clear floor area of 1500 mm by 1500 mm diameter within the perimeter of the shelter;
- e. ensure door or clear opening at least 920 mm wide;
- f. ensure overhead clearance is 2100 mm (minimum) at bus flag post;
- g. include a shelter-style bench, clear of the immediate area inside the entrance:
 - i. with a seat height between 450 mm and 500 mm from ground;
 - ii. with armrests and a backrest; and
 - iii. with high tonal contrast with surroundings to enhance visibility;
- h. ensure all glazed panels surrounding station shelters incorporate decals and other safety features, including:
 - i. a horizontal row of red decals or a continuous strip, minimum 50 mm wide, mounted with its centre line at a height of 1350 mm to 1500 mm from the floor or ground;
 - ii. where decals are used, locate at a maximum of 150 mm from centre to centre;
 - iii. ensure decals used are 50 mm square or round, and/or of a special design (e.g., a logo) provided the solid portion of the decals provides high tonal contrast and is easy to identify by persons with vision loss; and
 - iv. where frameless glass panels are used, identify exposed edge with a vertical moulding of high tonal contrast (e.g., safety yellow), applied to cap the end glass panel.

Best Practice

Provide a roof that is designed to prevent rain, snow, or ice accumulation at the entrance and the adjacent routes.

6.20.2 On-Street Bus Stops and Shelters

6.20.2.1 General Site Requirements

- a. provide a firm, stable and slip-resistant surface;
- b. ensure a grade with no slope steeper than 1:50 (2%); and
- c. ensure shelters, street furniture and equipment, including benches, bus flags, garbage receptacles, bike racks, newspaper stands, etc., do not obstruct the accessible route.

6.20.2.2 Boarding and Alighting Areas

- a. provide a loading area for customers using a mobility device with a clear length of 2400 mm, measured perpendicular to the curb or vehicular route edge, and a clear width of at least 1500 mm, measured parallel to the vehicular route (**Figure 114 and 116**).

6.20.2.3 On-Street Bus Shelter

Where provided at an on-street bus stop:

- a. locate on a uniform precast/poured concrete pad;
- b. provide level access to the adjacent sidewalk, walkway or accessible route;
- c. ensure a clear unobstructed view of oncoming traffic;
- d. provide an unobstructed clear floor area at least 1500 mm diameter directly inside the shelter entrance (**Figure 111**);
- e. ensure clear opening is at least 920 mm wide (**Figure 112**);
- f. ensure overhead clearance is 2100 mm (minimum) at bus flag post (**Figure 113**);
- g. include a bench, clear of the immediate area inside the entrance, consistent with Section 6.20.1.4.g Station Shelters;
- h. ensure all glazed shelter panels incorporate decals and other safety features, including:
 - i. a horizontal red continuous strip, minimum 50 mm wide, mounted with its centre line at a height of 1350 mm to 1500 mm, measured from the base of shelter (**Figure 112**);
 - ii. where decals are used, locate at a maximum of 150 mm from centre to centre;
 - iii. ensure any decals used are 50 mm square or round, and/or of a special design (e.g., a logo) provided the solid portion of the decals provides high tonal contrast and is easy to identify by persons with vision loss;
 - iv. where frameless glass panels are used, identify exposed edge with a vertical moulding of high tonal contrast (e.g., safety yellow), applied to cap the end glass panel; and
- i. provide a roof that is designed to prevent rain, snow, or ice accumulation at the entrance and adjacent routes.

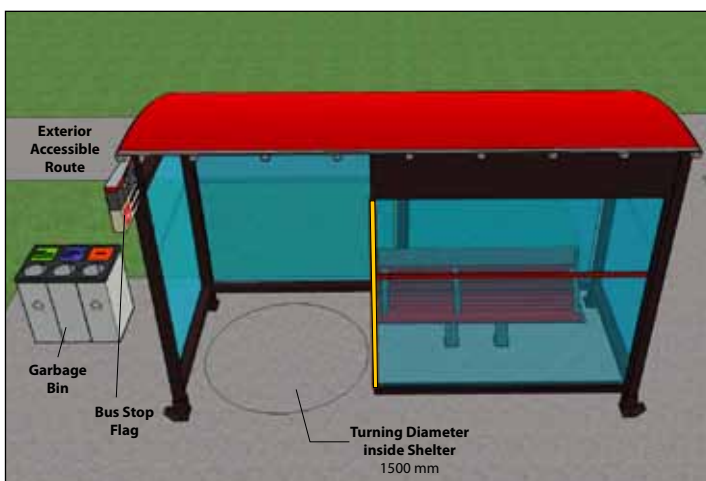

Figure 111: On-Street Bus Shelter

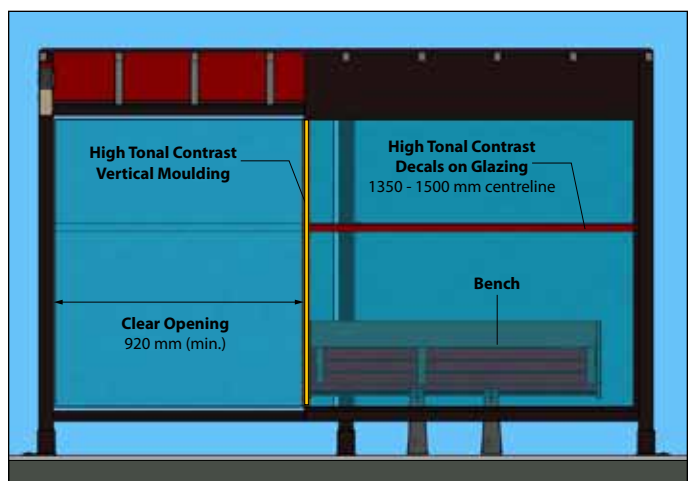

Figure 112: On-Street Bus Shelter - Front Elevation View

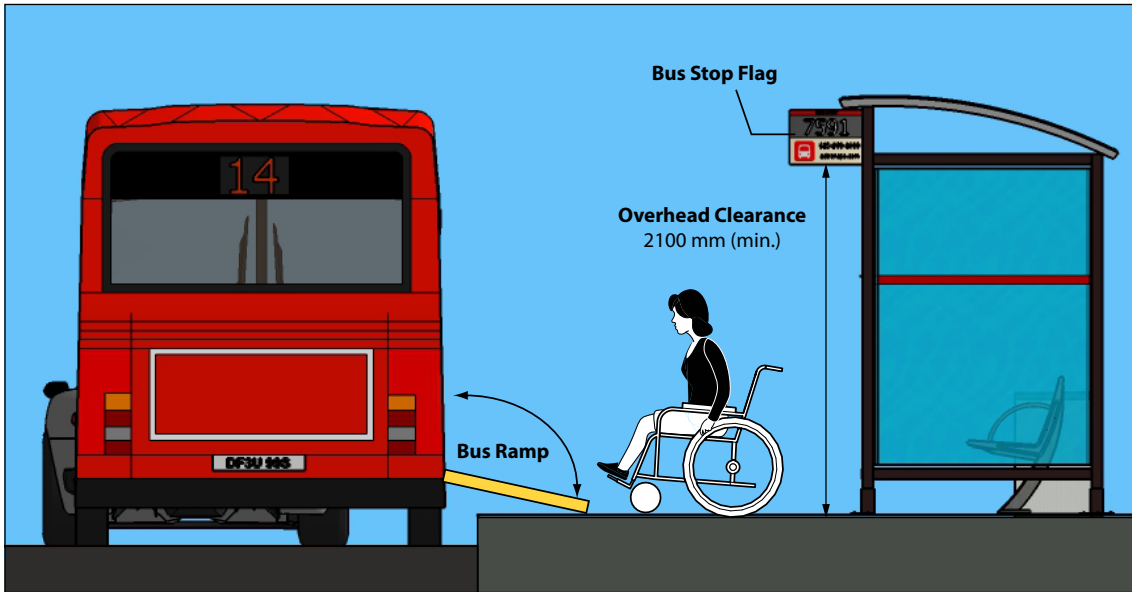

Figure 113: On-Street Bus Shelter - Side Elevation View

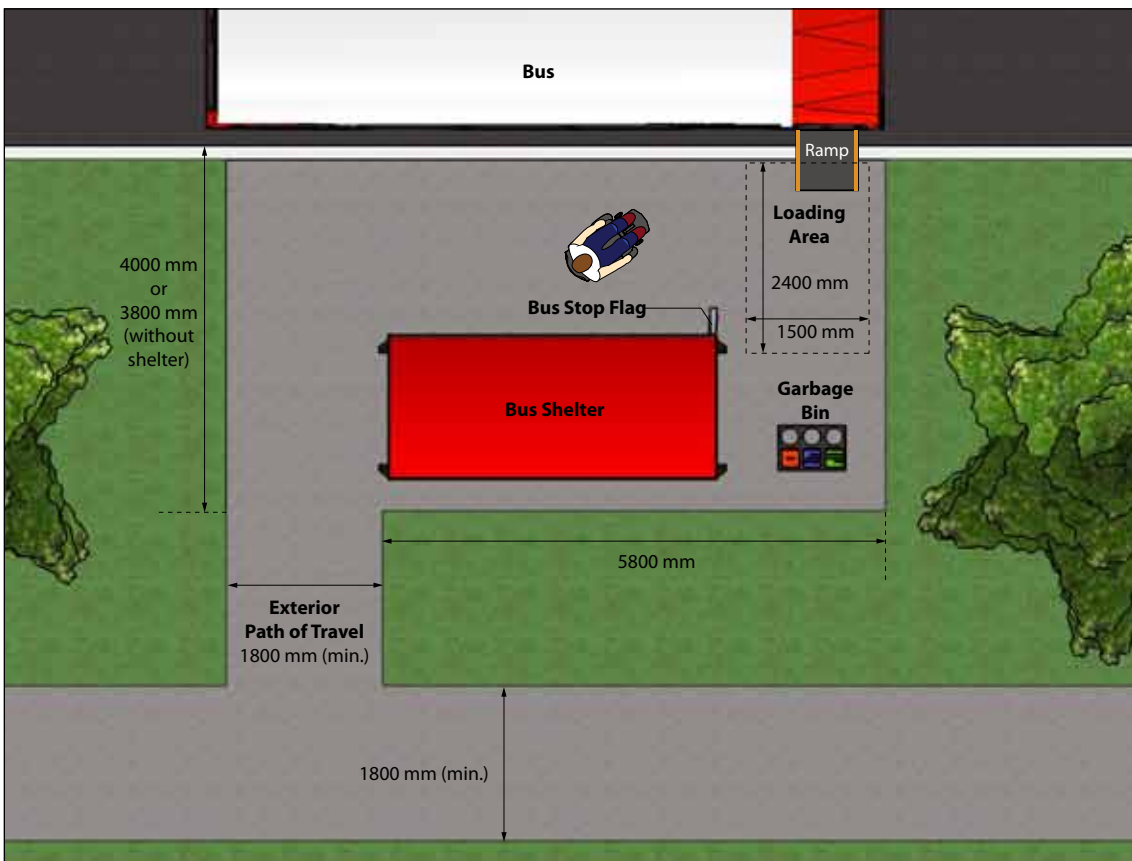

Figure 114: Typical On-Street Bus Shelter - Plan View

6.20.2.4 Street Furniture and Equipment

Where provided at an on-street bus stop:

- a. locate bus stop flag pole adjacent to the accessible route / sidewalk (**Figures 115 and 116**);
- b. provide signage on the bus stop flag pole or shelter that:
 - i. identifies the stop number and the routes serving the stop; and
 - ii. is consistently located and of uniform design;
- c. provide a bench outside the shelter, consistent with Section 2.10.1 Benches and Seats;
- d. provide a clear space of 915 mm wide by 1370 mm long minimum adjacent to the bench outside (**Figure 116**);
- e. ensure that there are no sharp edges or corners on equipment, such as poles and signs; and
- f. orient garbage/recycling receptacle dependent on optional advertising panels at the end of the shelters.



Figure 115: Typical On-Street Bus Stop

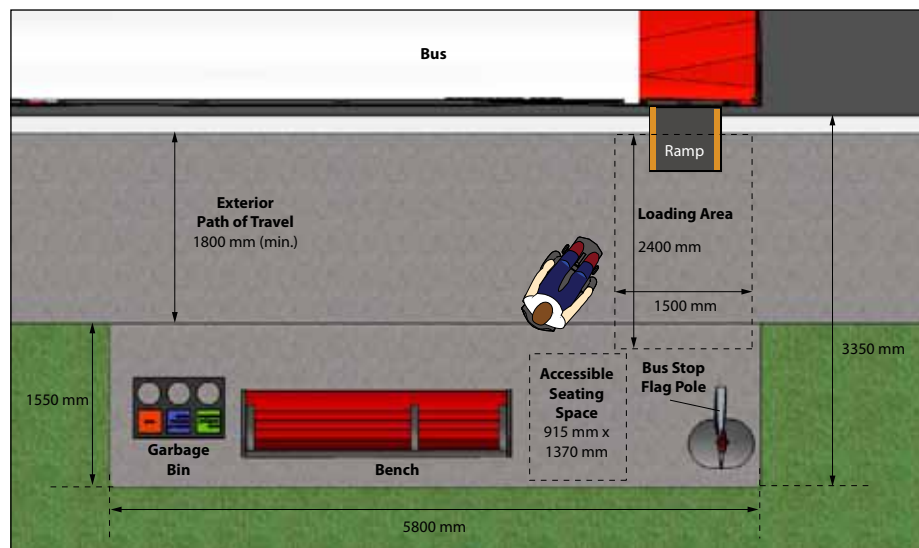

Figure 116: Typical On-Street Bus Stop - Plan View



Reserved

This section is reserved for a future update.

[Page intentionally left blank for printing purposes.]

Appendices

7.0

Table of Contents

7.1	Glossary	231
7.2	List of Figures.....	236
7.3	List of Tables	240
7.4	Exterior Maintenance Checklist.....	241
7.5	Interior Maintenance Checklist	243
7.6	Feedback Form	246
7.7	Tactile Signage Standard Pictograms	248

[Page intentionally left blank for printing purposes.]

Glossary

7.1

Term	Definition
Access Aisle	Refers to an accessible and safe pedestrian space or route used for loading and unloading from vehicle, as well as safe travel to and from designated accessible parking spaces to nearest accessible route / entrance. Access aisles include pavement markings for easy identification and are often shared between accessible parking spaces.
Accessible	Refers to any space, feature, element, site, environment or facility that can be used (e.g., located, approached, entered, exited or operated) by people with varying disabilities, with or without the use of mobility aids or assistive devices. Can also refer to services, practices and programs.
Accessible Route	A continuous, unobstructed path (interior or exterior) connecting users to accessible elements, features, amenities and spaces. Typically, accessible routes include parking access aisles, pedestrian sidewalks and curb ramps and interior corridors, floors, elevators and ramps.
Accommodation	A term used to reflect how an individual's needs are met for unique circumstances where a solution may not be "technically" feasible or practical to implement. Where barriers continue to exist because it is impossible to remove those barriers at a given point in time, then accommodation should be provided to the extent possible, short of "undue hardship". There is no set formula for accommodating people with disabilities. Each person's needs are unique and must be considered afresh when an accommodation request is made. A solution may meet one person's requirements but not another's, although it is also the case that many accommodations will benefit large numbers of persons with disabilities. Accommodating an individual's needs through differential treatment must be achieved in a manner that maximizes integration and dignity.
Adaptable	The ability of a certain building space or element, such as kitchen counters, sinks, or grab bars, to be added or altered so as to accommodate the needs of individuals with or without disabilities or to accommodate the needs of persons with different types or degrees of disabilities.
Ambient Light	The total amount of light in a space, including daylight or artificial light, whether from direct sources or reflected from surfaces in that space.
Amenities	Features or services that are usable by the public that typically increase physical comfort throughout the built environment (e.g., washrooms, resting areas, telephones, drinking fountains or food vending machines).
Amenity Strip	A section of a path or sidewalk that is set aside for placement of street furniture (e.g., benches, hydro poles, vending machines and post boxes), to ensure it is located away from pedestrian path of travel.
Anthropometrics	Refers to the study of human physical measurement, movement and proportions of the human body, with respect to reach ranges, sight lines, etc.
Area of Refuge (or Rescue Assistance)	A safe holding area which has been designated in a Fire Safety Plan, with direct access to an exit and is equipped with separate ventilation and communication equipment. It is a place where people can wait temporarily until they can exit safely or await further instructions or assistance during an emergency evacuation.
Arena	Refers to an enclosed, indoor venue, often circular or oval-shaped and designed to showcase a variety of performance or sporting events (e.g., hockey, basketball, football or soccer) in a large open space, typically surrounded on most or all sides by tiered seating for spectators. Often, the key feature of an arena is that the event space is the lowest point, allowing for maximum visibility.
Assembly Area	A room or space accommodating a group of individuals for educational, recreational, political, social, civic or amusement purposes, or for the consumption of food and drink.
Assistive Listening Systems (ALS)	Assistive listening systems (ALS) augment standard public address and audio systems by providing signals which can be received directly by persons with special receivers or their own hearing aids and which eliminate or filter background noise. The type of assistive listening system appropriate for a particular application depends on the characteristics of the setting, the nature of the program, and the intended audience. Magnetic induction loops, infrared and radio frequency systems are types of listening systems which are appropriate for various applications. Refer to Induction Loop or Infrared Assistive Listening Systems.

Term	Definition
Audible Signals	Signals which emit a distinctive sound, communication or alert to provide a warning or indicate a readiness to respond (e.g., alarm bell or signal).
Automatic Door	A door equipped with electronic sensors allowing it to be opened and triggered when pedestrians approach (e.g., typically sliding doors or swing doors equipped with guardrails for safety). See Power-Assisted Door.
Barrier	Refers to anything that prevents a person with a disability from fully participating in any aspect of society because of their disability. This can include a physical barrier, an architectural barrier, an information or communication barrier, an attitudinal barrier, or a technological barrier for example. It can also include policies and practices that result in an obstacle or hardship (e.g., systemic barrier).
Blended Curb	A connection with a slope of 1:20 (5%) or less between the level of a pedestrian walkway and the level of a crosswalk.
Bollard	Typically a 900 mm high (minimum) post to mark a pedestrian path from vehicular traffic.
Braille	Braille is a system of touch reading for the blind which employs embossed dots evenly arranged to represent numbers and letters. Literary Braille, as officially approved, comprises of two grades. Grade 1 Braille is in full spelling and consists of the letters of the alphabet, punctuation, numbers, and a number of composition signs which are special to Braille. Grade 2 Braille consists of Grade 1 and 189 contractions and short-form words, typically used for signage where space is limited.
Change Room	See Dressing Room.
Circulation Route or Path	An exterior or interior pedestrian way used for traveling from one place to another.
Clear Floor Space	The amount of unobstructed floor or ground space required to accommodate a single stationary user, or a mobility device / aid, such as wheelchairs, scooters, canes and crutches.
Closed Circuit	A telephone with dedicated line(s), such as a house phone, courtesy phone or phone that must be used to gain entrance to a building or part thereof.
Closer	See Door Closer
Common Use	Refers to those interior and exterior rooms, spaces or elements that are made available for regular and daily for use by the occupants or visitors of a facility. (e.g., common use areas of an office may include kitchens, reception areas, washrooms, etc.).
Communication Devices and Systems	Devices that enable or enhance the ability of people to receive or transmit information, usually electronically, for communication.
Cross-Slope	The slope that is perpendicular to the direction of travel. Opposite of running slope.
Crosswalk	That part of a roadway at an intersection that is marked for safe pedestrian crossing (e.g., by lines or other markings on the surface).
Curb Ramp	A sloped ramp surface cutting through a curb or built up to it (e.g., between the sidewalk and the road surface).
Dais	Refer to Stage.
Deaf	A term to describe people with a severe to profound hearing loss (90 decibels or greater), with little or no residual hearing. Lowercase deaf is used when referring to the medical / audio logical condition of having little or no hearing, while uppercase Deaf refers to individuals who identify themselves as deaf and share a culture and community, not just a medical condition.
Deafened	A term used to describe individuals who grow up hearing or hard of hearing and suddenly, or gradually, experience a profound loss of hearing. Late-deafened adults usually cannot understand speech without visual clues such as print interpretation (e.g., computerized note taking), speech reading or Sign Language.
Disability	Describes a functional limitation or activity restriction caused by an impairment. Common types include: sensory (e.g., vision or hearing), mobility, physical, cognitive, learning or mental health disabilities. Refer to the Ontario Human Rights Code for a detailed definition of disabilities.
Door Closer	A device or assembly used to open or close a door automatically.
Door Jamb	The vertical component of a door frame.
Dressing Room	Home or visiting team locker rooms that are not for the general public, but dedicated to the group using the playing areas (e.g., hockey arena, soccer field or basketball court). Generally contains showers, benches and washroom amenities.
Egress (Means of)	Means of egress refers to a continuous path of travel provided for the escape of persons from any point in a building leading to a point of safety (e.g., a separate building or an exterior open space protected from fire exposure), including exits and exit routes.
Elevator Lobby	The waiting area in front of an elevator.

Term	Definition
Entrance	An access point into a building or portion of a building or facility used for the purpose of entering. An entrance includes the approach, the vertical access leading to the entrance platform, the entrance door, landing area, vestibules (if provided), the entry door or gate, and the hardware of the entry door or gate. The principal or main entrance of a building or facility is the door through which most people typically enter (e.g., highest level of use).
Exit	The part of a means of egress, including doorways, that leads from the floor area it serves to a separate building, an open public thoroughfare, or an exterior open space protected from fire exposure from the building and having access to an open public thoroughfare.
Facility	All or any portion of buildings, structures, elements, improvements, equipment and pedestrian or vehicular routes located on a site or in a public right-of-way, where specific programs or services are provided or activities performed.
Fire Safety	A general term typically relating to the ability of a building or site to resist, suppress or control the onset and spread of fire and the protection of building occupants.
Fire Safety Plan	An operational plan that provides information, directions, strategies and recommendations for the safe evacuation of users during fire emergencies.
Firm Surface	Refers to a surface that does not deform under the vertical forces exerted by permitted users. Reference ASTM F 1951 Standard.
Flare Sides	A sloped surface that flanks a curb ramp and provides a graded transition between the ramp and the sidewalk. Flares bridge differences in elevation and are intended to prevent ambulatory pedestrians from tripping. Flares are not considered part of the accessible route.
FM Assistive Listening System	FM assistive listening systems are variations on the commercial FM radio. Radio signals are broadcast by an FM transmitter that is piggybacked on the sound system used in the facility. These signals are received by individual "radios", which are small pocket-size receivers tuned to the specific frequency used in the transmission.
Foot-Candle (FC)	Refer to measurements of the visible light intensity on a surface, a distance from the light source. One foot-candle is equivalent to the illumination produced by one candle (an optical standard reference) at a distance of 305 mm (one foot). One foot-candle equals approximately ten lux. Foot-candle is the imperial measure. Refer to Lux.
Forward Approach	Where a person will make use of a service counter, drinking fountain, or any other usable element of the built environment, by positioning their body or mobility aid directly in front of and facing the element.
Glare	Often refers to uncomfortably bright light reflected from a surface, floor, window or screen. Glare occurs when one part of the environment is much brighter than the general surrounding area, causing annoyance, discomfort or loss in visual performance.
Grade	The slope parallel to the direction of travel that is calculated by dividing the vertical change in elevation by the horizontal distance covered.
Guard	Protective barrier to prevent accidental falls at openings in floors and at the open sides of stairs, landings, balconies, mezzanines and ramps. Handrail supports often act as guards.
Hard of Hearing	A term used to describe people with a hearing loss who rely on residual hearing to communicate through speaking and speech-reading, as well as to hold conversations on the telephone. The degree of hearing loss can range from mild to profound. People who are hard of hearing can understand some speech sounds, with or without a hearing aid, and communicate primarily by speech. Persons who are hard of hearing often use hearing aids, lip reading and other assistive technologies.
Illumination	The combined amount and intensity of lighting provided, measured in foot-candles or lux.
Kilonewton (kN)	Equals 1000 Newtons.
Induction Loop Assistive Listening System	Induction loop assistive listening systems use a wire around the room to transmit an electromagnetic signal that is picked up by a small telecoil in the hearing aid. Users simply switch on this telecoil (the "T" setting) and adjust the volume of the hearing aid, if necessary. Loop systems are generally used by fewer people with hearing loss due to advances in hearing aid technology.
Infrared Assistive Listening System	Infrared assistive listening systems operate on infrared light that is beamed from one or several infrared transmitters to small, specialized receivers. There are several types of infrared receivers: stethoscope-style that dangle from the ears, a headset type that fits over the ears, and a small pocket-size type similar to the FM receiver. Where confidential transmission is essential (e.g., a court room setting), an infrared system generally is more effective recognizing transmission will be restricted within a given space.
Lavatory	A washbasin or sink used for personal hygiene.
Lux	The metric measurement for light intensity or illumination. See Foot-Candle.
Maneuvering Space	The minimum floor or ground area needed for users of mobility aids to move into or out of a place, space or along an accessible pathway or route.
Mobility Aids (or Devices)	A term used to encompass the variety of assistive devices used by people with mobility / physical types of disabilities, including manual and power wheelchairs, scooters, canes and crutches.

Term	Definition
Newtons (N)	The amount of force needed to move 1 kilogram of an object 1 meter per second squared.
Operable Control	The part of equipment or appliances that is used to insert or withdraw objects, to activate or deactivate, or to adjust the equipment or appliance (e.g., a coin slot, pushbutton or handle).
Operable Portion	A part of a piece of equipment or appliance, used to insert or withdraw objects or to activate, deactivate or adjust the equipment or appliance, such as a coin slot, push button or handle.
Passenger Loading Zone	Designated and signed area used for loading and unloading of passengers into or out of a waiting vehicle.
Pedestrian Access	An accessible route or corridor for pedestrian use within the public right-of-way.
Pictogram	A pictorial symbol or image that represents activities, facilities, spaces or concepts.
Platform Lift	An elevating device which is used to transport a person (with or without assistive equipment) between levels on a platform. A vertical platform lift is a self-contained unit, with or without an enclosure. An inclined platform lift is used for staircases.
Power-Assisted Door	A door with a mechanism that opens the door automatically, upon the activation of a switch, button or a control. The door also remains in the "open" position for a set period of time to allow safe passage. See Automatic Door.
Public Entrance	An entrance that is not a service entrance or a restricted entrance.
Public Use	Buildings, facilities and interior or exterior rooms, spaces, sites or elements that are made available to the public and that are typically owned, operated or leased by the City of Ottawa.
Ramp	A walking surface with a running slope steeper than 1:20.
Running Slope	The slope that is parallel to the direction of travel expressed as a ratio of rise to run. Opposite of cross-slope.
Service Counter	A raised surface on which business is transacted. Service counters can be comprised of either built-in (e.g., kiosks) or loose furniture (e.g., podiums). Other examples of service counters include: ATMs, checkout counters, self service kiosks, food vendor, and information counters.
Service Entrance	An entrance not intended for use by the public and used primarily for delivery of goods and services.
Side Approach	Where a person will make use of a service counter, drinking fountain, or any other usable element of the built environment, by positioning their body or mobility aid perpendicular to the element.
Sidewalk	A public right-of-way designated for pedestrian use and typically located between the curb or roadway and the adjacent property line.
Sightline	The line of view between a person in an audience and a performance, speaker or displayed item.
Sign or Signage	A sign is a means of conveying information about direction, location, safety or form of action and in general should be designed to be clear, concise and consistent. Signage displays text, symbols, tactile or pictorial information.
Site	A parcel of land bounded by a property line or a designated portion of a public right-of-way.
Slip-Resistant	A surface that provides sufficient frictional counterforce to the forces exerted in walking to permit safe ambulation.
Sprinklered	Refers to a building or any part of a building equipped with an automatic sprinkler system.
Stable Surface	Refers to a surface that does not deform or erode under the angular forces of permitted users travelling in a straight line or turning.
Stage	Refers to a space designed primarily for performances and is typically elevated from the audience seating area.
Stair System	Refers to combined elements that make up a typical stair, including steps, landings, and handrails, for example.
Street Furniture	Elements in the public right-of-way that are intended for use by pedestrians, including benches, lighting fixtures, waste dispensers and paper vending machines, for example.
Tactile	Describes an object that can be perceived using the sense of touch, and typically provided for users with vision loss.
Tactile Walking Surface Indicator (TWSI)	A surface detectable underfoot or by a long white cane, to assist persons with low vision or blindness by alerting or guiding them.
Touch Tour	Typically refers to tours provided by museums or other cultural / arts facilities that allow users with vision loss to touch and feel objects, displays and features, for example to gain a sensory understanding of objects and allow individual exploration. Tactile experiences may include: replicas, models, props, and handling objects which convey one aspect of the work.
Transfer Space	An unobstructed area adjacent to a fixture or furniture, allowing the positioning of a mobility aid to assist users with transferring to the fixture or furniture.
TTY, Teletypewriter or Text Telephone	TTY is the abbreviation for "teletypewriter" and refers to a means of electronic communication between deaf people or deaf and hearing people using interactive, text-based communication. Used in conjunction with a telephone, this device transmits and received typewritten messages using coded signals across the standard telephone network. The term TTY also refers to devices known as "text telephones" and TDD's.
Universal Access	A broad term to reflect the intended goal of inclusion for all, based on the principles of universal design or the "design of products and environments to be usable by all people, to the greatest extent possible, without the need for adaptation or specialized design" (Ron Mace).

Term	Definition
Universal Trail	An objective method of documenting trail conditions for universal access. The UTAP:
Assessment Process or UTAP	<ul style="list-style-type: none"> - documents actual trail conditions; - enhances user safety through accurate information about trail conditions; - increases access for people of all abilities; - identifies maintenance needs; - creates accessibility information; - enhances environmental protection; - facilitates trail planning and budgeting; - enables informed choice of trails based on interests and abilities; - inventories trails and facilities; and - documents patterns of trail use.
Video Signage	Video signage refers to video devices such as televisions, computer monitors / screens, and flat panel displays that may be used to provide information (e.g., directories). Advantages of video signs include the use of motion to attract attention, and the ability to rapidly update the content of the signs.
Vision Loss	This term usually refers to a progressive decrease in visual acuity. However, it can refer to the sudden onset of substantial acuity decrease or total blindness.
Vision Panel	A glazed opening in a door leaf which allows people to see through to the other side without opening the door.
Wayfinding	<p>A term used to describe a variety of means for spatial orientation and finding your way to a destination.</p> <p>Wayfinding design describes a variety of means for helping people find their way, through touch, print, signage, architecture and landscaping, for example.</p>

List of Figures

7.2

Title	Page no.
Section 2.0 Common Elements	
Figure 1: Joints Between Surfaces - Section View	20
Figure 2a: Grating Opening	22
Figure 2b: Gratings - Section View	22
Figure 3: Ramp Design Features	25
Figure 4a: Curb Protection - Cross Section	25
Figure 4b: Solid Barrier Protection - Cross Section	25
Figure 4c: Rail Protection - Cross Section	25
Figure 5: Typical Ramp Configurations	26
Figure 6a: Door Swings into Ramp Landing - Plan View	26
Figure 6b: Door Swings Away From Ramp Landing - Plan View	26
Figure 7a: Handrail Returns to Guard or Rail	27
Figure 7b: Handrail Returns to Wall	27
Figure 8: Handrail Design and Features - Section View	27
Figure 9: Guard Provision at Ramp - Section View	28
Figure 10: Stair Design Features - Section View	30
Figure 11: Tactile Walking Surface Indicators (TWSI) at Top of Stairs	31
Figure 12: Handrail Extensions at Stairs - Section View	32
Figure 13: Continuous Handrails at Landings - Plan View	32
Figure 14a: Handrails on Wall - Section View	34
Figure 14b: Handrails in Recessed Area - Section View	34
Figure 15: Protruding Objects	36
Figure 16: Protection Options Underneath Stairs	37
Figure 17: Rest Area - Plan View	39
Figure 18: Truncated Dome Specification	41
Figure 19: Clear Floor Space Requirements and Approach at Drinking Fountain - Plan View	43
Figure 20: Drinking Fountain Design and Layout - Elevation View	44
Figure 21: Clear Floor Space Requirements at Accessible Public Telephone	47
Figure 22: Public Telephone Provisions and Layout	47
Figure 23: Typical Accessible Bench Dimensions - Section View	50
Figure 24a: Knee and Toe Clearances - Elevation View	51
Figure 24b: Clear Floor Space Requirements and Approach at Tables and Work Surfaces - Plan View	51

Title	Page no.
Section 3.0 Exterior Environments	
Figure 25: Accessible Parking Space Dimensions - Plan View	64
Figure 26: Accessible Parking Vertical Signage	65
Figure 27: Accessible Parking Pavement Marking	65
Figure 28: Passenger Loading Zone - Plan View	68
Figure 29: Accessible Loading Zone Vertical Signage	68
Figure 30a: Minimum Clear Width of Exterior Accessible Path of Travel	71
Figure 30b: Reduced Clear Width and Required Passing Area	71
Figure 30c: Rest Area	71
Figure 31a: Running Slope	71
Figure 31b: Cross-Slope	71
Figure 32a: Edge Protection - Change in level between 200 and 600 mm adjacent to accessible path of travel	72
Figure 32b: No Guard Required - Surface adjacent to the accessible path of travel is not steeper than 1:2 within 1200 mm from the accessible path of travel (Exception)	72
Figure 32c: Guard - Change in level more than 600 mm or where the slope of the adjacent surface within 1200 mm from the accessible path of travel is greater than 1:2	73
Figure 33a: Typical Curb Ramp	77
Figure 33b: Typical Curb Ramp Design - Plan View	77
Figure 34: Transition Area - Counter Slope (Cross Section XX)	78
Figure 35: Typical Depressed Corner Design - Plan View	78
Section 4.0 Interior Environments	
Figure 36: Main or Primary Entrance Features	84
Figure 37: Clear Width of Doors - Plan and Elevation Views	86
Figure 38: Accessible Controlled Gate	87
Figure 39: Example of Control for Power Door Operator Promoting Universal Use	88
Figure 40a: Power Door Operator Control Mounting Location - Plan View	89
Figure 40b: Vertical Extended Power Door Operator - Elevation View	90
Figure 40c: Circular Power Door Operator Control - Elevation View	90
Figure 41: Recessed Door - Plan View	91
Figure 42: Guard at Door - Elevation View	91
Figure 43a: Pull Side Approach at Recessed Side-Hinged Door - Plan View	92
Figure 43b: Push Side Approach at Recessed Side-Hinged Door - Plan View	92
Figure 43c: Front and Side Approach at Side-Hinged Door - Plan View	93
Figure 43d: Front and Side Approach at Sliding Door - Plan View	93
Figure 43e: Hinge Side Approach at Side-Hinged Door - Plan View	93
Figure 43f: Latch Side Approach at Side-Hinged Door - Plan View	93
Figure 44: Doors in Series - Plan View	94
Figure 45: Glazed Doors - Elevation View	95
Figure 46: Vision Panels - Elevation View	95
Figure 47a: Clear Width (Typical)	98
Figure 47b: Required Passing Area for Routes Greater than 30 metres if Width is less than 1600 mm	98
Figure 47c: Permitted Reduced Clear Width	98
Figure 48a: 180 Degree Turn (Typical)	98
Figure 48b: 180 Degree Turn Around Obstacle greater than 1200 mm	98

Title	Page no.
Section 4.0 Interior Environments	
Figure 49: Running Slope	99
Figure 50: Cross-Slope	99
Figure 51: Example of Multiple Occupancy Washroom Layout	105
Figure 52: Universal Washrooms	107
Figure 53: Water Closet Stall - Space Requirements	109
Figure 54: Water Closet Stall Features	109
Figure 55: Horizontal Grab Bar (Water Closet with Water Tank)	111
Figure 56: L-Shaped Grab Bar (Water Closet with Flush Valve)	111
Figure 57a: Fold Down Grab Bar - Plan View	112
Figure 57b: Fold Down Grab Bar - Elevation View	112
Figure 58a: Lavatories - Section View	113
Figure 58b: Lavatories - Plan View	113
Figure 59: Typical Washroom Amenities	114
Figure 60a: Folding Baby Changing Station - Section View	115
Figure 60b: Adult-size Change Table	116
Figure 61a: Urinals - Side Elevation View	117
Figure 61a: Urinals - Front Elevation View	117
Figure 62: Shower Design and Layout - Plan View	119
Figure 63: Drying Area - Plan View (Best Practice)	119
Figure 64: Shower Design - Section View	121
Section 5.0 Common Systems, Controls and Communications	
Figure 65: Colour Contrast Between Background and Control	126
Figure 66: Control Mounting Heights - Elevation View	126
Figure 67a: Maximum Mounting Height for an Obstructed Forward Approach and Reach	127
Figure 67b: Maximum Mounting Height over an Obstruction of 860 mm (maximum) for Side Approach and Reach	127
Figure 68: Proximity Card Reader Location - Plan View	135
Figure 69: Fire Safety and Evacuation Features - Elevation View	137
Figure 70: Examples of International Symbols of Accessibility	144
Figure 71: Character Features and Sizes	145
Figure 72: Example of Typical Pictograms and Symbols	145
Figure 73: Mounting Location of Signage with Tactile Features - Elevation View	147
Figure 74: Signage with Tactile Features	147
Figure 75: Tactile Map (Best Practice)	147
Figure 76: Window Design Features - Elevation View	150

Title	Page no.
Section 6.0 Special Facilities and Spaces	
Figure 77: Accessible Seating Space Dimensions	155
Figure 78: Lines of Sight	155
Figure 79: Accessible Seating Plan - Example of Viewing Positions	155
Figure 80: Meeting Room Design and Layout	158
Figure 81a: Food Displays and Tray Slides - Section View	162
Figure 81b: Aisle Width - Plan View	162
Figure 82: Pass-Through or Galley Kitchen - Plan View	165
Figure 83: U-Shaped Kitchen - Plan View	166
Figure 84: L-Shaped Kitchen - Plan View	166
Figure 85: Example of Kitchen with Typical Amenities and Appliances	167
Figure 86: Kitchen Storage - Elevation View	168
Figure 87: Kitchen Storage	168
Figure 88: Sink - Elevation View	169
Figure 89: Accessible Sink	169
Figure 90: Cooktop - Elevation View	170
Figure 91: Cooktop	170
Figure 92: Clear Floor Space at Refrigerators and Freezers	171
Figure 93: Library Design and Layout - Plan View	173
Figure 94: Library Security Gate, Service Counter and Book Drop Slot	174
Figure 95: Book Stacks	174
Figure 96: Sloped Entry or Ramp to Swimming Pool	178
Figure 97a: Universal Change Room or Stall - Plan View	183
Figure 97b: Grab Bar Dimensions	183
Figure 98: Balcony / Terrace - Plan View	185
Figure 99: Example of Typical Service Counter	187
Figure 100: Dimension of Accessible Service Counter	187
Figure 101: Clear Floor Space Requirements at Accessible Service Counter - Plan View	188
Figure 102: Waiting Area - Plan View	190
Figure 103: Fixed Queuing Guides	191
Figure 104: Elevated Platform or Stage - Plan View	193
Figure 105a: Picnic Table Design and Features - Plan View	198
Figure 105b: Picnic Table Design and Features - Elevation View	198
Figure 106: Example of Trail with Multiple Trailhead Options	200
Figure 107: Trail Clear Width	201
Figure 108: Example of Typical Universal Trail Assessment Process (UTAP) Signage	203
Figure 109: Transfer Systems	213
Figure 110: Turning Space - Plan View	213
Figure 111: On-Street Bus Shelter	224
Figure 112: On-Street Bus Shelter - Front Elevation View	224
Figure 113: On-Street Bus Shelter - Side Elevation View	225
Figure 114: Typical On-Street Bus Shelter - Plan View	225
Figure 115: Typical On-Street Bus Stop	226
Figure 116: Typical On-Street Bus Stop - Plan View	226

List of Tables

7.3

Title	Page no.
Section 2.0 Common Elements (Exterior and Interior)	
Table 1: Truncated Dome Spacing Requirements	41
Table 2: Minimum Number of Accessible Telephones Required	46
Section 3.0 Exterior Environments	
Table 3: Accessible Parking Provision Requirements	62
Table 4: Change in Level - Slope Requirements	72
Section 4.0 Interior Environments	
Table 5: Minimum Clearance at Doors	92
Table 6: Minimum Dimensions for Elevator Car and Door Clear Width	101
Table 7: Minimum Number of Universal Washrooms per Building	104
Table 8: Minimum Number of Water Closet Stalls Required to be Accessible	104
Table 9: Minimum Number of Accessible Showers	119
Section 5.0 Common Systems, Controls and Communications	
Table 10: Character Height Relative to Viewing Distance	145
Section 6.0 Special Facilities and Spaces	
Table 11: Common Assembly Areas	153
Table 12: Accessible and Adaptable Seating Requirements in Assembly Areas	154
Table 13: Percentage of Elevated Play Components Required to be Connected to Transfer Systems	212
Table 14: Ground-Level Play Component Alternatives to Elevated Play Components	214

Exterior Maintenance Checklist

7.4

Application

The following checklist is designed for use by City Staff for conducting regular reviews of maintenance issues that may impact on accessibility.

Exterior Maintenance Checklist

A regular maintenance schedule should be identified by the City (e.g., daily, weekly, monthly etc.), based on departmental responsibilities.

1. Signage <i>(Ref. Section 5.8 Signage and Wayfinding)</i> <i>This section does not apply</i> <input type="checkbox"/>				
Item	Requirements	Compliance	Accessibility Issues	Location Reference
1	Are site and facility signage (e.g., facility name and street address) clearly visible from the street and sidewalk and kept free of obstructions?	<input type="checkbox"/> Y <input type="checkbox"/> N <input type="checkbox"/> N/A		
2	Where provided, is signage (e.g., directional, identification signage) throughout exterior maintained and clearly visible?	<input type="checkbox"/> Y <input type="checkbox"/> N <input type="checkbox"/> N/A		
3	Is signage properly illuminated to ensure legibility?	<input type="checkbox"/> Y <input type="checkbox"/> N <input type="checkbox"/> N/A		
4	Is signage provided to identify amenities (e.g., public telephone) and is it clearly visible?	<input type="checkbox"/> Y <input type="checkbox"/> N <input type="checkbox"/> N/A		

2. Accessible Parking Spaces and Passenger Loading Zones <i>(Ref. Section 3.1 Parking and 3.2 Passenger Loading Zones)</i> <i>This section does not apply</i> <input type="checkbox"/>				
Item	Requirements	Compliance	Accessibility Issues	Location Reference
5	Is the proper use of designated accessible parking spaces by drivers with disabilities (e.g., with valid permits displayed) enforced?	<input type="checkbox"/> Y <input type="checkbox"/> N <input type="checkbox"/> N/A		
6	Are parking spaces, including access aisles, kept clear of obstacles and other obstructions (e.g., garbage, gravel / grit, snow and ice). NOTE: Ensure the entire area of the parking space is maintained during winter when snow and ice is on the ground.	<input type="checkbox"/> Y <input type="checkbox"/> N <input type="checkbox"/> N/A		
7	Is the parking surface in good condition (e.g., free of disrepair such as cracks, heaving, uneven surfaces, potholes)?	<input type="checkbox"/> Y <input type="checkbox"/> N <input type="checkbox"/> N/A		
8	Are pavement markings provided at parking spaces legible?	<input type="checkbox"/> Y <input type="checkbox"/> N <input type="checkbox"/> N/A		

Interior Maintenance Checklist

7.5

Application

The following checklist is recommended as a starting point for City Staff when conducting maintenance audits of interior environments.

Interior Maintenance Checklist

A regular maintenance schedule should be identified by the City to address the requirements identified within this checklist (e.g., daily, weekly, monthly etc.).

1. Facility Entrance (Ref. Section 4.1 Entrances) This section does not apply <input type="checkbox"/>				
Item	Requirements	Compliance	Accessibility Issues	Location Reference
1.1	Are power door operators in good working condition?	<input type="checkbox"/> Y <input type="checkbox"/> N <input type="checkbox"/> N/A		
1.2	Is building directory signage (including maps / floor plans) kept up to date?	<input type="checkbox"/> Y <input type="checkbox"/> N <input type="checkbox"/> N/A		

2. Accessible Parking Spaces (where provided in parking garage, underground parking) (Ref. Section 3.1 Parking) This section does not apply <input type="checkbox"/>				
Item	Requirements	Compliance	Accessibility Issues	Location Reference
2.1	Is the proper use of designated accessible parking spaces by drivers with disabilities (e.g., with valid permits displayed) enforced at all times?	<input type="checkbox"/> Y <input type="checkbox"/> N <input type="checkbox"/> N/A		
2.2	Are parking spaces, including access aisles, kept clear of obstacles and other obstructions (e.g., garbage)?	<input type="checkbox"/> Y <input type="checkbox"/> N <input type="checkbox"/> N/A		
2.3	Is the parking surface, including access aisles, in good condition (e.g., free of disrepair such as cracks, heaving, uneven surfaces, potholes)?	<input type="checkbox"/> Y <input type="checkbox"/> N <input type="checkbox"/> N/A		
2.4	Are pavement markings provided in good condition?	<input type="checkbox"/> Y <input type="checkbox"/> N <input type="checkbox"/> N/A		
2.5	Is vertical signage provided at designated accessible parking spaces clearly visible and in good condition?	<input type="checkbox"/> Y <input type="checkbox"/> N <input type="checkbox"/> N/A		
2.6	Where provided, are curb ramps kept free of obstructions?	<input type="checkbox"/> Y <input type="checkbox"/> N <input type="checkbox"/> N/A		
2.7	Are accessible routes from parking spaces leading to facility entrance clearly marked and free of obstructions?	<input type="checkbox"/> Y <input type="checkbox"/> N <input type="checkbox"/> N/A		

3. Interior Accessible Routes (Ref. Section 4.3 Interior Accessible Routes) This section does not apply

Item	Requirements	Compliance	Accessibility Issues	Location Reference
3.1	Is the width of accessible routes maintained to ensure easy maneuverability for users of mobility aids?	<input type="checkbox"/> Y <input type="checkbox"/> N <input type="checkbox"/> N/A		
3.2	Are routine inspections undertaken to ensure junctions between different flooring materials do not become worn or uneven and present potential tripping hazards?	<input type="checkbox"/> Y <input type="checkbox"/> N <input type="checkbox"/> N/A		
3.3	Are floor surfaces routinely inspected to ensure glare issues are reduced?	<input type="checkbox"/> Y <input type="checkbox"/> N <input type="checkbox"/> N/A		
3.4	Are suitable cleaning products used to ensure polished floors are not slippery when wet and / or cause glare?	<input type="checkbox"/> Y <input type="checkbox"/> N <input type="checkbox"/> N/A		
3.5	Where applicable, are overhead projections no lower than 2100 mm?	<input type="checkbox"/> Y <input type="checkbox"/> N <input type="checkbox"/> N/A		
3.6	Where provided, are power door operators in good working condition?	<input type="checkbox"/> Y <input type="checkbox"/> N <input type="checkbox"/> N/A		
3.7	Are all elevators regularly serviced by qualified personnel (e.g., based on a regular maintenance schedule)?	<input type="checkbox"/> Y <input type="checkbox"/> N <input type="checkbox"/> N/A		
3.8	Are considerations made prior to redecoration to maintain a careful colour scheme with suitable colour contrasts?	<input type="checkbox"/> Y <input type="checkbox"/> N <input type="checkbox"/> N/A		

4. Accessible Washrooms (Ref. Section 4.5 Washrooms) This section does not apply

Item	Requirements	Compliance	Accessibility Issues	Location Reference
4.1	Are accessible washrooms and stalls kept clear at all times?	<input type="checkbox"/> Y <input type="checkbox"/> N <input type="checkbox"/> N/A		
4.2	Is lighting level maintained and suitable in accessible washrooms?	<input type="checkbox"/> Y <input type="checkbox"/> N <input type="checkbox"/> N/A		
4.3	Are all washroom accessories in good working condition?	<input type="checkbox"/> Y <input type="checkbox"/> N <input type="checkbox"/> N/A		
4.4	Are grab bars securely fixed with no obstructions along grasping surface?	<input type="checkbox"/> Y <input type="checkbox"/> N <input type="checkbox"/> N/A		
4.5	Where applicable, are emergency alarms and controls routinely checked by qualified personnel?	<input type="checkbox"/> Y <input type="checkbox"/> N <input type="checkbox"/> N/A		

5. Systems and Controls (ref. Section 5.0 Systems, Controls and Communications) This section does not apply

Item	Requirements	Compliance	Accessibility Issues	Location Reference
5.1	Are mechanical systems / units maintained to reduce background noise that is problematic for people with hearing loss?	<input type="checkbox"/> Y <input type="checkbox"/> N <input type="checkbox"/> N/A		
5.2	Are Assistive Listening Systems (e.g., induction loops and infra red systems) identifiable with appropriate signage and checked regularly, where provided in assembly rooms, multi-purpose rooms, etc.?	<input type="checkbox"/> Y <input type="checkbox"/> N <input type="checkbox"/> N/A		
5.3	If applicable, is the central TTY monitored routinely and is there someone designated to monitor it?	<input type="checkbox"/> Y <input type="checkbox"/> N <input type="checkbox"/> N/A		
5.4	Is staff awareness training re: disability issues implemented to ensure they can provide assistance if required?	<input type="checkbox"/> Y <input type="checkbox"/> N <input type="checkbox"/> N/A		

6. Fire and Life Safety Systems (Ref. Section 5.6 Fire and Life Safety Systems) This section does not apply

Item	Requirements	Compliance	Accessibility Issues	Location Reference
6.1	Are emergency exit routes regularly checked for potential barriers and obstructions?	<input type="checkbox"/> Y <input type="checkbox"/> N <input type="checkbox"/> N/A		
6.2	Are maps of the facility's evacuation routes and related safety plan information kept up to date (e.g., when offices or other spaces are reconfigured)?	<input type="checkbox"/> Y <input type="checkbox"/> N <input type="checkbox"/> N/A		

Feedback Form

7.6

The City of Ottawa would like to receive comments and information related to any proposed changes to these Accessibility Design Standards.

Please include section referencing, revised wording and reasons for proposed changes.

Submit to:

City of Ottawa
Accessibility Office
110 Laurier Av. West, 1st Floor Client Service Centre
Ottawa, Ontario
K1P 1J1
accessibilityoffice@ottawa.ca

Submitted by:

Name: _____
Company / Organization: _____
Phone Number: _____
Address: _____

Email: _____

Proposed Changes and Rationale: _____



Tactile Signage Standard Pictograms





Application



Standard tactile signage pictograms that are used across the City's portfolio of facilities are provided in this Appendix for reference.





7.7





Reference





Sec. 5.8 Signage & Wayfinding





English	French	Pictogram
Accessible	Accessible	
Accessible unisex washroom	Toilettes mixte accessibles	
Arena	Aréna	
Arena viewing	Vue sur l'aréna	
Assistive workstation	Poste de technologie d'aide	





English	French	Pictogram
Auditorium	Auditorium	
Bar	Bar	
Baseball diamond	Terrain de jeu	
Bathroom stalls	Toilettes	
Boardroom	Salle de conférence	

English	French	Pictogram
Café	Café	
Canteen	Cantine	
Ceramics	Céramique	
Change room	Vestiaire	
Change table	Table à langer	





English	French	Pictogram
Classroom	Salle de classe	
Coat Room	Vestiaire	
Computer room	Salles des ordinateurs	
Craft studio	Studio d'artisanat	
Curling rink	Patinoire de curling	





English	French	Pictogram
Dance studio	Studio de danse	
Dental clinic	Clinique dentaire	
Dining lounge	Salle à manger	
Drinking fountain	Fontaine à boire	
Electrical room	Local de service électrique	





English	French	Pictogram
Elevator (a)	Ascenseur (a)	
Emergency phone	Téléphone d'urgence	
Exercise room	Salle d'exercise	
Family change room	Vestiaire familial	





English	French	Pictogram
Female change room (a)	Vestiaire des femmes (a)	
Female washroom (a)	Toilettes des femmes (a)	
First aid	Premiers soins	
Information	Information	
Janitor's closet	Local d'entretien	
Janitors room	Salle des concierges	





English	French	Pictogram
Kitchen	Cuisine	
Lawn bowling	Boulingrin	
Library	Bibliothèque	
Lockers	Casiers	
Lockerettes	Petits casiers	





English	French	Pictogram
Male change room	Vestiaire des hommes	
Male Washroom (a)	Toilettes des hommes (a)	
Martial arts	Arts martiaux	
Massage therapy	Massothérapie	
Mechanical room	Local de service mécanique	





English	French	Pictogram
Meeting room	Salle de réunion	
Music room	Salle de musique	
No entry	Accès interdit	
Office / First Aid	Bureau / Premiers soins	
PC tutorial room	Salle de formation	



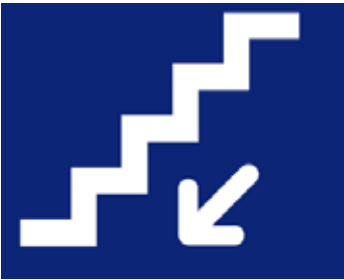

English	French	Pictogram
Pool	Piscine	
Pottery studio	Studio de poterie	
Prayer room	Lieu de paix	
Preschool washroom	Toilette préscolaire	





English	French	Pictogram
Racquetball	Racquetball	
Referee / First aid	Arbitre / premiers soins	
Referee	Arbitre	
Referee room	Local des arbitres	
Referees	Arbitres	
Referees change room	Vestiaire des arbitres	
Resource centre	Centre de documentation	
Restaurant	Restaurant	



English	French	Pictogram
Rink	Patinoire	
Sauna	Sauna	
Servery	Dépense	
Sinks	Lavabos	
Showers	Douches	

English	French	Pictogram
Shuffleboard	Jeu de palets	
Sledge hockey	Hockey sur luge	
Spinning room	Salle de cardiovélo	
Squash	Squash	

English	French	Pictogram
Squash viewing	Vue sur le squash	
Stairs	Escaliers	
Steam room	Bain de vapeur	
Storage	Rangement	
Swirl pool	Pisane à remous	

English	French	Pictogram
Theatre	Théâtre	
Telephone	Téléphone	
Ticket booth	Guichet	
Tickets	Billets	
Urinals	Urinoirs	
Viewing platform	Plateforme d'observation	
Viewing ramp	Rampe de vue	

English	French	Pictogram
Viewing stand	Tribune	
Visual arts	Arts visuels	
Washrooms (a)	Toilettes (a)	
Weight room	Salle de musculation	
Wheelchair lift	Ascenseur de fauteuil roulant	

English	French	Pictogram
Whirlpool	Bain hydromasseur	
Yoga room	Salle de yoga	
Zamboni room	Local de la zamboni	